



Impressora Zebra ZQ610 Plus e ZQ620 Plus

Com a Impressora de Etiquetas Portátil Zebra ZQ610 Plus e ZQ620 Plus você melhora o gerenciamento de inventário e o atendimento ao cliente em sua loja, adicionando tecnologia avançada e design inovador.

ZQ610 Plus

ZQ620 Plus

Mobile Printers



User Guide



ZEBRA

Contents

Proprietary Statements	6
Document Conventions	8
Introduction to the ZQ610 Plus and ZQ620 Plus Printers	9
Unpacking and Inspection	10
Reporting Damage	10
ZQ610 Plus and ZQ620 Plus Technology	11
PowerPrecision+ (PP+) Battery 	11
Printing Technology	12
QR Code	13
Made for iPhone (MFi)	13
Near Field Communication (NFC)	14
Color LCD Display	14
ZQ6 Plus Overview	15
Getting Ready to Print	17
Battery	17
Removing the Battery	17
Removing the Battery Tape Insulator	18
Installing the Battery	19
Battery Safety	20
Charger Safety	20
Smart Charger-2 (SC2) Single Battery Charger	21
Charging Status Indicators	21
Battery Health Indicator	21

SC2 Dimensions	22
Model UCLI72-4 Quad Charger	22
AC Power Adapter	24
Charging the Battery	25
To charge the battery using an AC Power Adapter:	25
Open the protective cover on the printer to expose the DC input charger jack.	25
Ethernet and Charging Cradles	25
LED Status Indicator	26
Printer Operation with Cradle.....	28
1-Slot Battery Charger	29
Charging Status Indicators.....	29
3-Slot Battery Charger	30
Loading Media into the ZQ6 Plus Printers	31
Loading Media Procedure.....	31
Loading Media in Peel-Off Mode	33
ZQ6 Plus Healthcare Printers	34
Operator Controls	36
Standard Control Panel.....	36
Normal Boot-up LED Behavior.....	37
Sleep Mode LED Behavior.....	37
Shutdown Behavior.....	37
Power LED Ring Behavior	38
LCD Control Panel	39
Status Bar Icons.....	40
Home Menu Screen	42
Home Screen Icons and Parameters.....	44
Alert Messages	45
Buttons	46
Power-Up Sequences	46
Runtime Sequences without LED Flashes.....	46
Sleep Mode.....	47
Adaptive Print Performance	48
Draft Mode	48
Verify the Printer is Working.....	49
Printing a Configuration Label.....	49
Connecting the Printer	50

Cable Communication.....	51
RS-232C Communications	51
USB Communications.....	51
Providing Strain Relief for Communications Cable	52
Installing Drivers and Connecting to a Windows-Based Computer .	53
Installing the Drivers	53
Running the Printer Installation Wizard.....	55
What to Do If You Forget to Install Printer Drivers First	60
Connect to a Phone or Tablet.....	63
Zebra Printer Setup Utilities	63
Adding a Printer through Zebra Setup Utilities.....	64
Wireless Communications with Bluetooth	71
Bluetooth Networking Overview	71
Bluetooth Security Modes	72
Bluetooth Minimum Security Modes	73
WLAN Overview.....	74
Setting Up the Software	75
Designing Labels	75
Using Pre-Printed Receipt Media.....	77
Black Mark Dimensions (Receipt Media)	77
Label Areas.....	77
Label Design Examples	78
Keep-Out Areas	79
Near Field Communication (NFC).....	80
NFC Use Cases	81
Passive	81
Wearing the Printer	82
Swivel Belt Clip	82
Adjustable Shoulder Strap	83
Soft Case	84
Hand Strap.....	85
Preventive Maintenance	86
Extending Battery Life	86
General Cleaning Instructions.....	86
LCD Control Panel Indicators	89
Troubleshooting Topics	90

Troubleshooting Tests	92
Printing a Configuration Label.....	92
Communications Diagnostics.....	92
Specifications	97
Printing Specifications.....	97
Memory and Communications Specifications	97
Label Specifications	98
CPCL Font and Bar Code Specifications and Commands.....	99
ZPL Font and Bar Code Specifications and Commands.....	100
Communication Ports.....	101
Physical, Environmental and Electrical Specifications.....	102
ZQ620 Plus Dimensions	103
ZQ620 Plus Mounting Hole Dimensions	104
ZQ610 Plus Dimensions	105
ZQ610 Plus Mounting Hole Dimensions	106
ZQ6 Plus Accessories.....	107
ZQ6 Plus Accessories cont.	108
Appendix A.....	109
Interface Cables (RS-232 Cables).....	109
USB Cables	110
Appendix B.....	111
Media Supplies	111
Appendix C.....	111
Maintenance Supplies.....	111
Appendix D.....	112
Appendix E.....	132
Appendix F	133
Battery Disposal.....	133
Product Disposal.....	133
Appendix G	134
Alert Messages	134
Appendix H.....	137
Using Zebra.com.....	137
Appendix I	139
Contact Support	139

Copyright

© 2023 ZIH Corp and/or its affiliates. All rights reserved. ZEBRA and the stylized Zebra head are trademarks of ZIH Corp., registered in many jurisdictions worldwide. All other trademarks are the property of their respective owners.

COPYRIGHTS AND TRADEMARKS: For complete copyright and trademark information, go to zebra.com/copyright

WARRANTY: For complete warranty information, go to zebra.com/warranty

END USER LICENSE AGREEMENT: For complete EULA information, go to zebra.com/eula

PATENTS: For complete patent information, go to zebra.com/patents

Terms of Use

Proprietary Statement: This manual contains proprietary information of Zebra Technologies Corporation and its subsidiaries (“Zebra Technologies”). It is intended solely for the information and use of parties operating and maintaining the equipment described herein. Such proprietary information may not be used, reproduced, or disclosed to any other parties for any other purpose without the express, written permission of Zebra Technologies.

Product Improvements: Continuous improvement of products is a policy of Zebra Technologies. All specifications and designs are subject to change without notice. **Liability Disclaimer:** Zebra Technologies takes steps to ensure that its published Engineering specifications and manuals are correct; however, errors do occur. Zebra Technologies reserves the right to correct any such errors and disclaims liability resulting therefrom.

Limitation of Liability: In no event shall Zebra Technologies or anyone else involved in the creation, production, or delivery of the accompanying product (including hardware and software) be liable for any damages whatsoever (including, without limitation, consequential damages including loss of business profits, business interruption, or loss of business information) arising out of the use of, the results of use of, or inability to use such product, even if Zebra Technologies has been advised of the possibility of such damages. Some jurisdictions do not allow the exclusion or limitation of incidental or consequential damages, so the above limitation or exclusion may not apply to you.

Monotype®, Intellifont® and UFST® are trademarks of Monotype Imaging, Inc. registered in the United States Patent and Trademark Office and may be registered in certain jurisdictions. Andy™, CG Palacio™, CG Century Schoolbook™, CG Triumvirate™, CG Times™, Monotype Kai™, Monotype Mincho™ and Monotype Sung™ are trademarks of Monotype Imaging, Inc. and may be registered in some jurisdictions. HY Gothic Hanguul™ is a trademark of Hanyang Systems, Inc. Angsana™ is a trademark of Unity Progress Company (UPC) Limited. Andale®, Arial®, Book Antiqua®, Corsiva®, Gill Sans®, Sorts® and Times New Roman® are trademarks of The Monotype Corporation registered in the United States Patent and Trademark Office and may be registered in certain jurisdictions. Century Gothic™, Bookman Old Style™ and Century Schoolbook™ are trademarks of The Monotype Corporation and may be registered in certain jurisdictions. HGGothicB is a trademark of the Ricoh company, Ltd. and may be registered in some jurisdictions.

Univers™ is a trademark of Heidelberger Druckmaschinen AG, which may be registered in certain jurisdictions, exclusively licensed through Linotype Library GmbH, a wholly owned subsidiary of Heidelberger Druckmaschinen AG.

Futura® is a trademark of Bauer Types SA registered in the United States Patent and Trademark Office and may be registered in some jurisdictions.

TrueType® is a trademark of Apple Computer, Inc. registered in the United States Patent and Trademark Office and may be registered in certain jurisdictions.

All other product names are the property of their respective owners.

“Made for iPod”, “Made for iPhone”, and “Made for iPad” mean that an electronic accessory has been designed to connect specifically to iPod, iPhone, or iPad, respectively, and has been certified by the developer to meet Apple performance standards. Apple is not responsible for the operation of this device or its compliance with safety and regulatory standards. Note that the use of this accessory with iPod, iPhone, or iPad may affect wireless performance.

Bluetooth® is a registered trademark of the Bluetooth SIG.

© 1996–2009, QNX Software Systems GmbH & Co. KG. All rights reserved. Published under license by QNX Software Systems Co.

All other brand names, product names, or trademarks belong to their respective holders.
©2023 ZIH Corp.

Works with:



Windows

Made for



iPod



iPhone



iPad

Certified by:



Document Conventions

Graphic icons are used throughout the guide. These icons and their associated meanings are described in the following list.



Caution • Warns you of the potential for electrostatic discharge



Caution • Warns you of a potential electric shock situation



Caution • Warns you of a situation where excessive heat could cause a burn



Caution • Advises you that failure to take or avoid a specific action could result in physical harm to you



Caution • Advises you that failure to take or avoid a specific action could result in physical harm to the hardware



Important • Advises you of information that is essential to complete a task



Note • Indicates neutral or positive information that emphasizes or supplements important points of the main text

Introduction to the ZQ610 Plus and ZQ620 Plus Printers

This guide gives you the information needed to operate the ZQ610 Plus and ZQ620 Plus printers. They use some of the latest technologies such as an 802.11ac/Bluetooth® 4.1 dual radio, a smart battery with PowerPrecision+ functionality, Near Field Communication (NFC), a color LCD display, and Made for iPhone® (MFi). MFi printers provide Apple® co-processor (MFi) support which allows an Apple device such as an iPhone or iPad® to authenticate and connect over Bluetooth.



These printers use CPCL, ZPL, and EPL programming languages. To create and print labels using these languages, refer to the Programming Guide for CPCL (p/n P1073699-001), ZPL (p/n P1012728-010) and EPL2 (p/n 14245L-003). Go to “Appendix H” on page 137 for instructions on how to access manuals on zebra.com.

ZQ610 Plus and ZQ620 Plus Software Utilities:

- ZebraNet Bridge Enterprise™: printer configuration, fleet management
- Zebra Setup Utility: single printer configuration, quick setup
- Zebra Mobile Setup Utility: Android™-based setup tool
- ZebraDesigner Pro v2: label design
- Zebra Designer Drivers: Windows® driver
- OPOS Driver: Windows driver
- Multiplatform SDK
- Zebra Downloader
- Printer Profile Manager Enterprise (PPME) (These utilities can be found on the Zebra website at zebra.com/support).

Unpacking and Inspection

- Check all exterior surfaces for damage.
- Open the media cover (“Loading Media into the ZQ6 Plus Printers” on page 31) and inspect the media compartment for damage.

In case shipping is required, save the carton and all packing material.



Note • Accessories may vary by region.

Reporting Damage

If you discover shipping damage:

- Immediately notify and file a damage report with the shipping company. Zebra Technologies Corporation is not responsible for any damage incurred during shipment of the printer and will not cover the repair of this damage under its warranty policy.
- Keep the carton and all packing material for inspection.
- Notify your authorized Zebra reseller.

ZQ610 Plus and ZQ620 Plus Technology

The ZQ610 Plus and ZQ620 Plus printers use several technologies made popular in other Zebra mobile printer product lines and newer, state-of-the-art technologies.

PowerPrecision+ (PP+) Battery

The ZQ6 Plus printers use a 2-cell Li-Ion battery pack with integrated intelligence and data storage capability meeting PowerPrecision+ (PP+) functionality. This intelligent battery has the integrated technology required to collect the detailed realtime battery metrics needed to maximize useful battery life, and ensure every battery is healthy and able to hold a full charge. In addition, technology inside the battery tracks and maintains the metrics required to provide real-time visibility into more meaningful battery statistics, such as total cycle usage of the battery, whether the battery is old and should be retired, or how long it takes a battery to fully charge.

Operating Temperature	Charging Temperature	Storage Temperature
-20–60°C (-4°F–140°F)	0–40°C (32–104°F)	-25–60°C (-13–140°F)
0–50°C (32–22°F) for Healthcare models		



Important • *The printers only function properly using genuine Zebra smart battery packs. To achieve the best fast charging results, charge batteries at room temperature with the device powered off. Ideal charging conditions are within temperatures from 5–40°C (41–104°F).*

The device always performs battery charging in a safe and intelligent manner. At higher temperatures, the device may, for small periods of time, alternately enable and disable battery charging to keep the battery at acceptable temperatures. Under abnormal temperatures, the device indicates when charging is unable to be initiated via its LED and a notification that appears on the display.

The smart battery's health has three states: GOOD, REPLACE, and POOR. The battery health factor determines whether or not the printer can operate and what is communicated to you via the display.

# of Charge Cycles	Health	Power-up Message
<300	GOOD	None
≥300 but <550	REPLACE	Battery Diminished Consider Replacing*
≥550 but <600	REPLACE	Warning-Battery Is Past Useful Life*
≥600	POOR	Replace Battery Shutting Down**

*** Warning accompanied by one long beep.**

**** Warning flashes on and off accompanied by beeping at a rate of once per second. After 30 seconds the printer shuts down.**



Note • Power down the printer before removing the battery to minimize the risk of corruption.

Printing Technology

The ZQ610 Plus and ZQ620 Plus printers use the Direct Thermal method to print human-readable text, graphics, and barcodes. It incorporates a sophisticated print engine for optimal printing under all operational conditions. Direct thermal printing uses heat to cause a chemical reaction on specially treated media. This reaction creates a dark mark wherever a heated element on the printhead comes in contact with the media. Since the printing elements are arranged very densely at 203 DPI (dots per inch) horizontal and 200 DPI vertical, highly legible characters and graphic elements are created a row at a time as the media advances past the printhead. This technology has the advantage of simplicity, as there is no requirement for consumable supplies such as ink or toner. However, since the media is sensitive to heat, it will gradually lose legibility over long periods of time, especially if exposed to environments with relatively high temperatures or in direct sunlight.

QR Code

The QR barcode includes a human readable text URL, for example zebra.com/zq600plus-info, which links you to printer information and short videos on topics such as buying supplies, features overview, loading media, printing a configuration report, cleaning instructions, and accessory information.

Figure 1 • QR Code (ZQ620 Plus Shown).



Made for iPhone (MFi)

ZQ610 Plus and ZQ620 Plus printers support communication with Apple devices running iOS® 10 or later over a standalone Bluetooth 4.1 radio and the BT4.1 radio included with the 802.11ac (dual) radio.



Near Field Communication (NFC)

The ZQ6 Plus printers support a passive NFC tag that complies with the Android Standard Tag format. The NFC tag is programmed from the factory and supports Bluetooth pairing to enable a tablet, smartphone, or mobile computer to automatically pair with the printer via a Bluetooth connection (within the bounds of the security profile being used).

The NFC tag also supports app launching whereby an app, developed either by Zebra or a third party, launches on an NFC-enabled smartphone, tablet, or mobile computer. Similarly, the NFC tag enables launching to a web support page via a tablet, smartphone, or mobile computer.

Color LCD Display

The ZQ610 Plus and ZQ620 Plus printers feature a color, non-touch LCD display which supports a 288x240 pixel viewable area. You are able to view the display in both room light and night time conditions. The display is capable of displaying colored text and images. To save power, the display dims after a configurable timeout.

ZQ6 Plus Overview

Figure 2 • Overview of Features (ZQ620 Plus Shown).

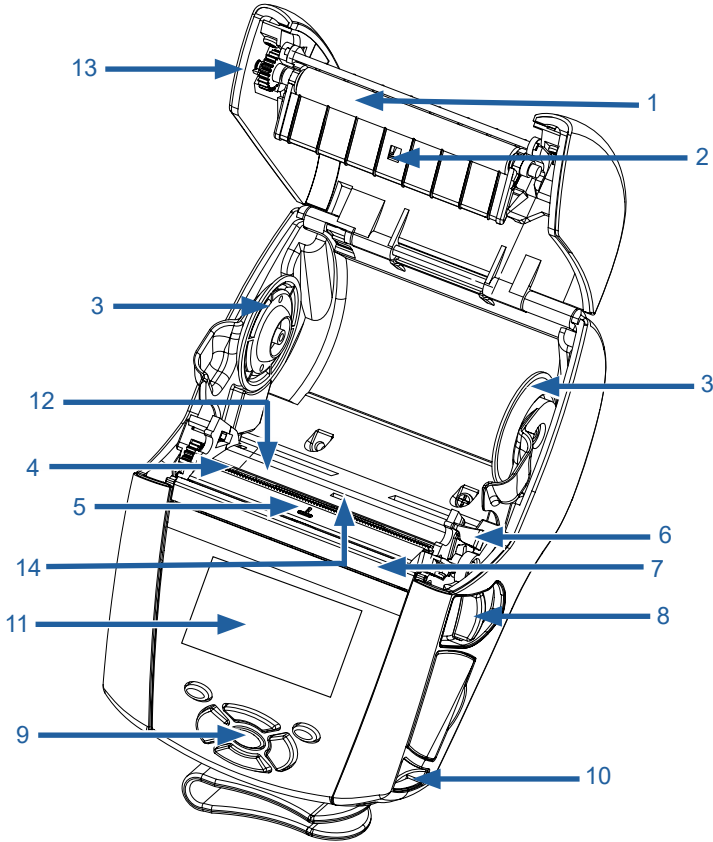

- | | |
|--------------------------------------|----------------------------|
| 1. Platen Roller | 18. Battery |
| 2. Black Bar Sensor | 19. USB/RS-232 Comm Ports |
| 3. Media Support Disks | 20. MAC Address Label |
| 4. Tear Bar | 21. Docking Contacts |
| 5. Label Presence Sensor | 22. DC Input |
| 6. Peeler Lever | 23. NFC (Print Touch Icon) |
| 7. Peeler Bail | |
| 8. Latch Release Lever | |
| 9. Key Pad | |
| 10. Strap Post | |
| 11. Color LCD | |
| 12. Printhead | |
| 13. Media Cover | |
| 14. Gap Sensor | |
| 15. Power Button (w/ Power Ring LED) | |
| 16. Feed Button | |
| 17. Belt Clip | |

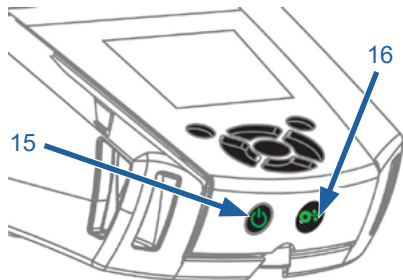

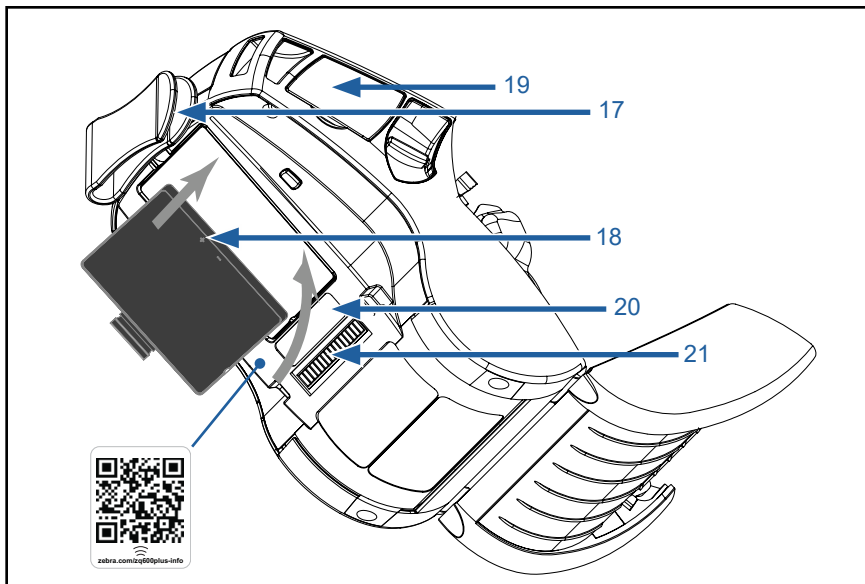

Note • Scanning the QR code with a smartphone provides printer-specific information at zebra.com/zq600plus-info.



Note • Tapping the Zebra Print Touch™ icon with a Near Field Communication (NFC) enabled smartphone provides instant access to printer-specific information. For more information about NFC and Zebra products, go to zebra.com/nfc. Bluetooth pairing applications via NFC is also possible. See Zebra Multi-platform SDK for more information.

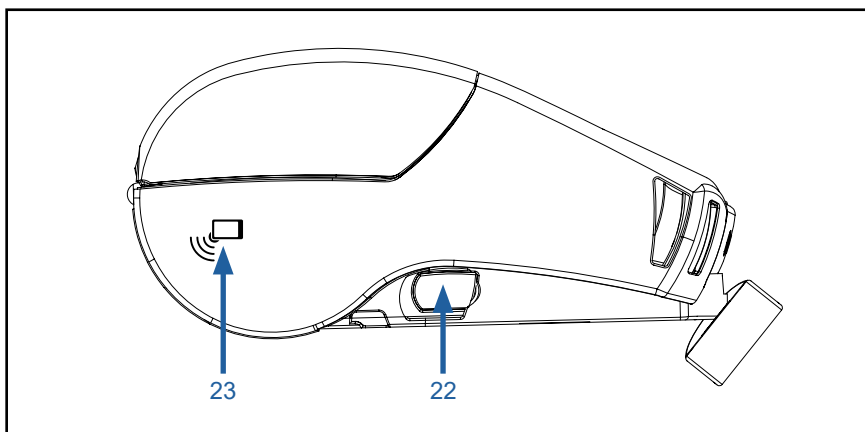

Battery

Installing/Removing Battery and Battery Tape Insulator



Important • Batteries are shipped in Sleep mode to preserve their maximum capacity while in storage prior to initial use. Plug in the AC adapter (page 24) or insert the battery into the 1-Slot Battery Charger (page 29) or 3-Slot Battery Charger (page 30), Smart Charger 2 (go to page 21), or Quad Charger (page 22) to wake it up before using for the first time.

Removing the Battery

1. If a belt clip is present on the bottom of the printer, rotate it such that it provides clearance for the battery.
2. Depress the latch on the battery pack (where indicated).
3. Rotate the pack away from the battery well. Lift the battery up and out of the printer.



Removing the Battery Tape Insulator

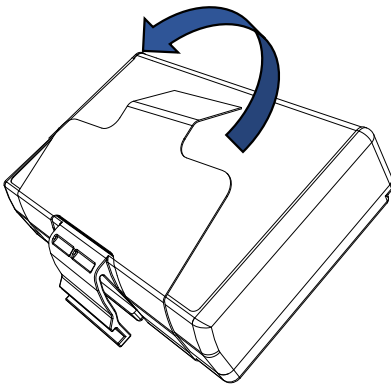

1. Pull up on the tape insulator tab located on the bottom of the battery pack.

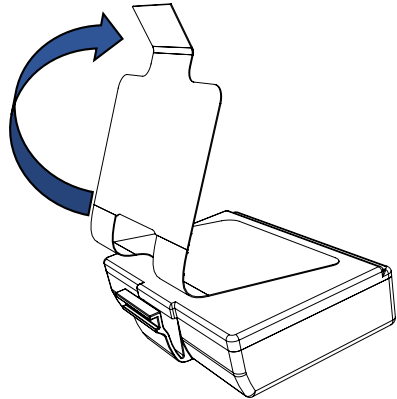

2. Peel back the tape insulator and remove it from the top of the battery pack. Discard upon removal.



Caution • Battery can explode, leak, or catch fire if improperly charged or exposed to high temperature. Do not disassemble, crush, puncture, short external contacts, or dispose in fire or water. Charge on a Zebra approved Lithium-Ion charger only.

Installing the Battery

1. Locate the battery compartment on the bottom of the printer (where indicated).
2. Swivel the belt clip (if present) to access the battery compartment.
3. Insert the battery into the printer as shown. (It is not possible to insert the pack in the incorrect orientation.)



4. Rock the battery into the compartment as shown until it locks in place.



Battery Safety



Caution • Avoid accidental short circuiting of any battery. Allowing battery terminals to contact conductive material creates a short circuit which could cause burns and other injuries, or could start a fire.



Important • Always dispose of used batteries properly. Go to "Appendix F" on page 133 for battery recycling information.



Caution • Use of any charger not approved specifically by Zebra for use with its batteries could cause damage to the battery pack or the printer, and will void the warranty.



Caution • Do not incinerate, disassemble, short circuit, or expose to temperatures higher than 65°C (149°F).

Charger Safety



Do not place any charger in locations where liquids or metallic objects may be dropped into the charging bays.

Smart Charger-2 (SC2) Single Battery Charger (p/n P1031365-063 with US Type-A Line Cord)

The Smart Charger-2 (SC2) is a charging system for use with the 2-cell and 4-cell lithium-ion smart batteries used in the ZQ6 Plus printers.

Charging Status Indicators

The SC2 uses an LED indicator to indicate the charge state in either Green, Yellow, or Amber as detailed below.

DC Power Input	Indicator	Battery Status
Present	Green	Battery not present
Present	Green	Fully charged
Present	Yellow	Charging
Present	Amber	Fault
Present	Off	Present and Battery Health = POOR

There is also a battery charging icon indicating the LED charging status.  Charge time for all batteries is 2 hours.

Battery Health Indicator

The SC2 features a tri-color (Yellow/Green/Amber) LED to indicate the health of the battery pack. Evaluating battery health begins when the battery is inserted into the charger and results with the appropriate LED illuminated as seen below. The LED remains illuminated as long as input power is applied.

Battery	Indicator	Health Status
None or non-smart	Off	
Smart battery present	Green	GOOD
Smart battery present	Yellow	CAPACITY DIMINISHED
Smart battery present	Flashing yellow	PAST USEFUL LIFE
Smart battery present	Amber	UNUSABLE-REPLACE (discard per Instructions in Appendix E)



Note • For detailed information on the SC2, refer to the Smart Charger 2 User Guide (p/n P1040985-001).

Figure 3 • Smart Charger-2 (SC2)

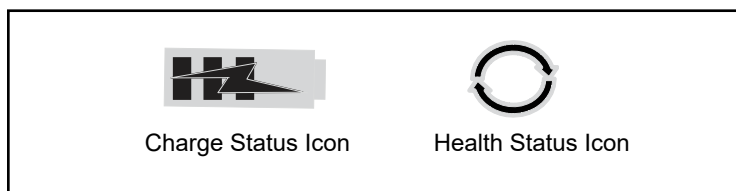
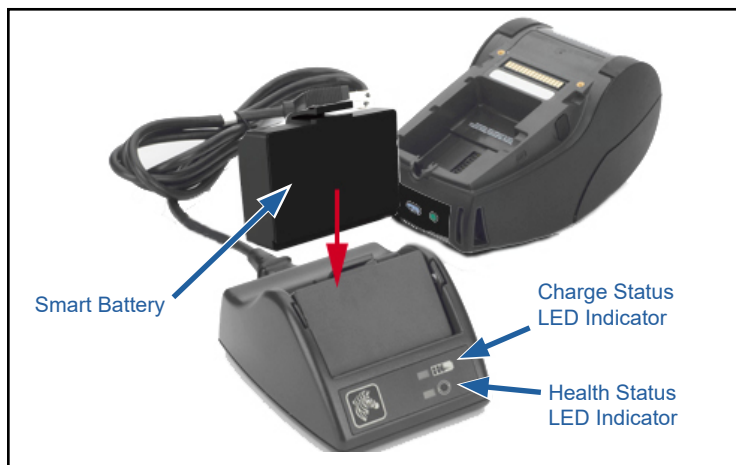

SC2 Dimensions

Height	Width	Length
65.1 mm (2.56 in.)	101.5 mm (4 in.)	120.9 mm (4.75 in.)

Model UCLI72-4 Quad Charger (AC18177-5 with US Type-A Line Cord)

The UCLI72-4 Quad Charger is designed to charge up to four ZQ6 Plus battery packs simultaneously. Batteries must be removed from the printer to be charged in the Quad Charger.

1. Ensure that the charger has been installed properly per the Quad Charger instruction manual. Ensure that the power indicator on the front panel is on.
2. Slide the battery pack into any one of the four charging bays (Figure 4) until it stops, noting the orientation. Then, rock the battery pack back until it snaps into place. The amber indicator below the charging battery turns on if the battery is properly inserted.

The indicators under the battery allows you to monitor the charging process per the table below:

Amber	Green	Battery Status
On	Off	Charging
On	Flashing	80% charged (OK to use)
Off	On	Completely Charged
Flashing	Off	Fault-Replace Battery



Important • A fault condition is caused by a problem with the battery. The charger may indicate a fault because the battery is too hot or cold to charge reliably. Charge the battery at the room’s ambient temperature. If the amber indicator flashes on the second attempt, the battery should be discarded. Always dispose of batteries in a proper manner as described in “Appendix F” on page 133.

Figure 4 • Quad Charger

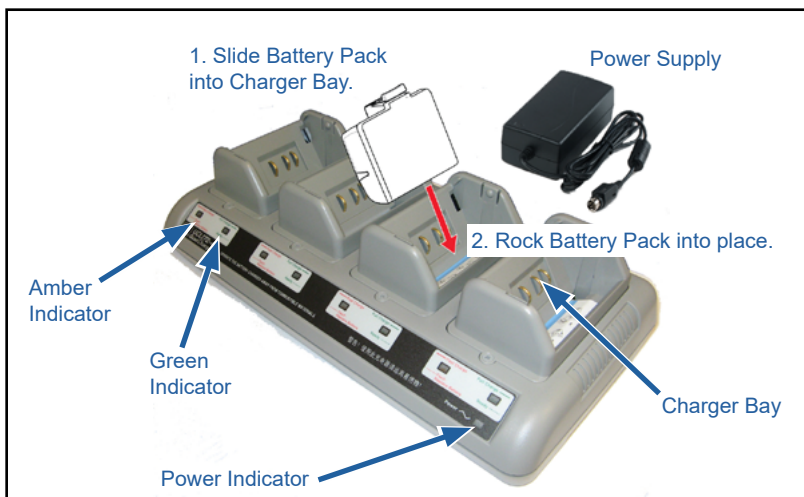

Partially charged battery packs take less time to reach their full charge state. Batteries that reach 80% of their charge capacity may be used, however, it is recommended that you allow the batteries to reach a full charge to maintain maximum battery life.



Note • The UCLI72-4 Quad Charger has a safety feature which stops charging a battery after 6 hours regardless of its charge state. If not fully charged, it might be indicative of a battery that needs to be replaced.



Important • Use care when installing the UCLI72-4 Quad Charger so that you do not block the ventilating slots on the top and bottom covers. Ensure the battery charger is plugged into a power source that will not turn off when charging overnight.

AC Power Adapter (p/n P1031365-024 with US Type-A Line Cord) (p/n P1065668-008 with US Type-A Line Cord for Healthcare Only)

Figure 5 • AC Power Adapter Charging

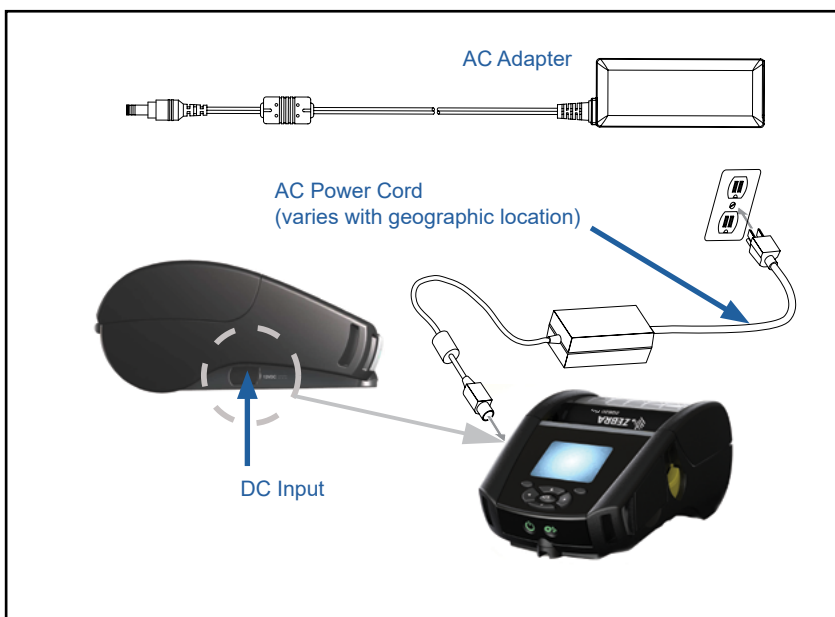

Charging the Battery

To charge the battery using an AC Power Adapter:

1. Open the protective cover on the printer to expose the DC input charger jack.
2. Connect the appropriate AC power cord for your location to the adapter, and then plug the power cord into an AC receptacle.
3. Plug the barrel plug from the AC adapter into the charger jack on the printer.
4. The printer powers up and begins charging. The printer can be left on or turned off at this point. Charging continues in either state.



Important • *While it is possible to charge the battery when using the printer, charge times increase under this condition.*

Ethernet and Charging Cradles

The cradle is an expansion base intended for use with the ZQ6 Plus printers. There is a four bay cradle (EC4) or a single bay option (EC) for use with the ZQ610 Plus and ZQ620 Plus, as shown on pages 26 and 27. The EC/EC4 cradles provide charging power to the docked printer and provides a standard 10/100 Mbps Ethernet port for communication to the printer. Both cradles also supply battery charging power to the docked printer and act as a supplementary power source.

The cradles feature two LED's to indicate the status of the cradle: Solid green to indicate when power is provided to the input of the cradle; and blinking green to indicate Ethernet activity. The cradles allow you to dock the printer easily and remove it with the push of a button. The printer remains operable while docked, that is, a display is viewable, charge LED status is viewable, and printer controls and data entry are available. The printer can print while docked and the you can replace the media as well.

LED Status Indicator

LED Status	Indication
Solid Green	Power On
Blinking Green	Ethernet Activity



Note • Remove the Docking Cradle Access label on the bottom of the printers before docking the printer in the cradle.



Note • Clean the docking contacts with a Zebra cleaning pen to remove any residue left behind by the label.

Figure 6 • 4-Bay Ethernet Cradle



Height	Width	Length
66.7 mm (2.62 in.)	579.9 mm (22.83 in.)	150.57 mm (5.93 in.)



Note • The ZQ610 Plus and ZQ620 Plus extended capacity battery is not compatible with the EC and EC4 cradles.

Figure 7 • Single Bay Ethernet Cradle



Cradle	Height	Width	Length
Single Bay Cradle	66.7 mm (2.62 in.)	171.28 mm (6.74 in.)	150.57 mm (5.93 in.)

Printer Operation with Cradle

- ZQ6 Plus printers charge when placed in their supported cradles.
- Docking the printer in the cradle will automatically turn the printer on to ensure it is available to be managed remotely.
- When the printer detects input power from the cradle, and the presence of a live Ethernet link, it will automatically connect to the Ethernet network.
- For printers with an 802.11 radio, this interface will be turned off when the Ethernet link is active. It will turn back on if the Ethernet link is no longer active.
- For printers with a Bluetooth radio, this interface will remain active while the printer is in the cradle.
- The serial and USB ports will remain active while the printer is in the cradle.
- The DC input barrel jack connector (see Figure 5) cannot be used while the printer is in the cradle. The DC barrel jack should be plugged directly into the cradle instead.



Note • The printer provides over voltage protection such that no damage occurs when voltages from 0-36V are applied at the DC Power jack. Upon application of voltage greater than 36V, the DC line fuse will permanently open to reduce fire hazard. The battery is only charged when 12VDC is applied using the Zebra AC adapter.

1-Slot Battery Charger (p/n SAC-MPP-1BCHGUS1-01SA with US Type-A Line Cord)

Use Case: Home Office/Small Business

The 1-Slot Battery Charger provides you with a single, spare battery charging solution. Similar to the 3-Slot Battery Charger, the single charger will charge a 2-cell battery from empty to fully charged in less than 4 hours and a 4-cell battery within 6 hours.

Figure 8 • 1-Slot Battery Charger

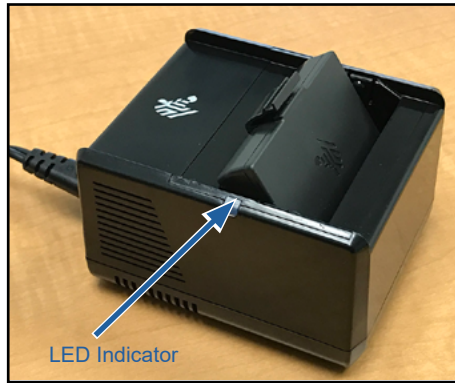

Charging Status Indicators

Both the 3-slot and 1-slot battery chargers use an LED indicator located next to each slot to indicate the charge state in either green, red, or amber as detailed below.

Mode	Charging Indication	Description
Charge Fault	● ○ ● ○	Fast blinking red
Charging (Healthy)	●	Solid amber
Charge Done (Healthy)	●	Solid green
Charging (Unhealthy)	●	Solid red
Charging Done (Unhealthy)	●	Solid red
Best Battery (Charging)	● ✨	Alternates between solid and bright bursts of amber
Best Battery (Charge Done)	● ✨	Alternates between solid and bright bursts of green

3-Slot Battery Charger

(p/n SAC-MPP-3BCHGUS1-01) Dual 3-Slot Battery Charger (p/n SAC-MPP-6BCHUS1-01) w/ US Type-A Line Cord

Use Case: Settlement Room

The 3-Slot Battery Charger is a charging system for use with the 2-cell lithium-ion batteries used in the ZQ6 Plus printers. The 3-slot charger is capable of charging three 2-cell batteries simultaneously from empty to full in less than 4 hours and 4-cell batteries within 6 hours. It can either be used as a standalone charger or mounted on a 5-slot share cradle.

Figure 9 • 3-Slot Battery Charger



Note • For detailed information on the 1-Slot, 3-Slot Battery Charger and 3-Slot Dual Pack Charger, refer to the P1131107-01EN Quick Start Guides at zebra.com/zq600plus-info.

Loading Media into the ZQ6 Plus Printers

You can operate ZQ6 Plus printers in one of two different modes: Tear-Off or Peel-Off. Tear-Off mode allows you to tear off each label (or a strip of labels) after it is printed. In Peel-Off mode, the backing material is peeled away from the label as it is printed. When printing batches, after you remove the label, the next one is printed.

Loading Media Procedure

1. Open the printer (Figure 10).
 - a. Slide down the Latch Release Lever on the side of the printer at (1). The Media Cover pops open.
 - b. Rotate the Media Cover back completely as shown at (2), exposing the media compartment and adjustable media supports.

Figure 10 • Opening the Printer

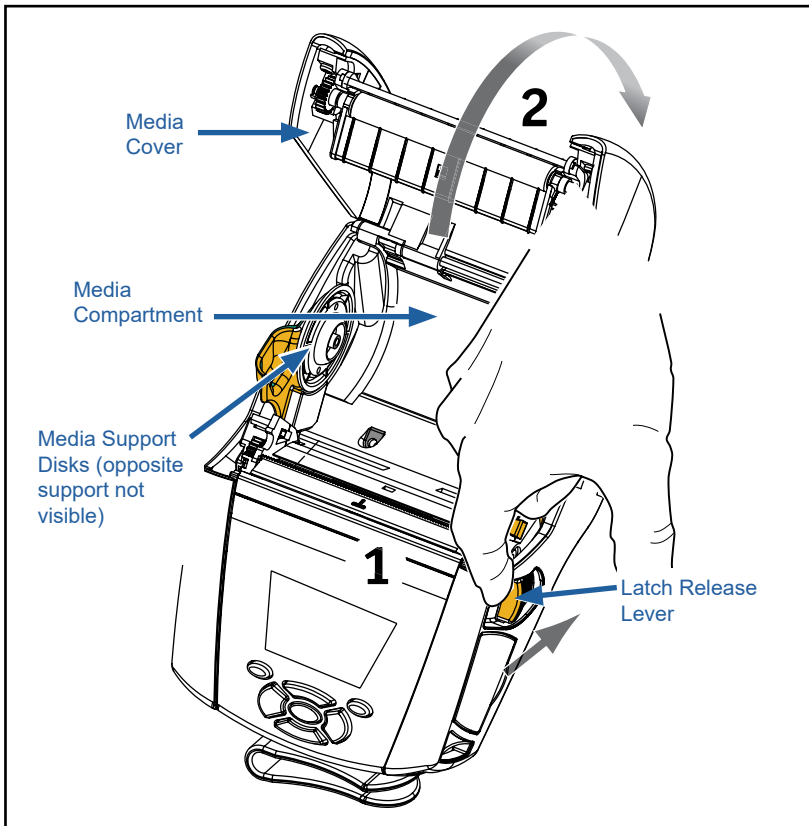

2. Pull the media supports apart (Figure 11) and insert the roll of media between the supports (follow the orientation shown). The supports secure the media in place and adjust to the width of the media. The media roll should be able to spin freely on the supports.

Figure 11 • Loading Media

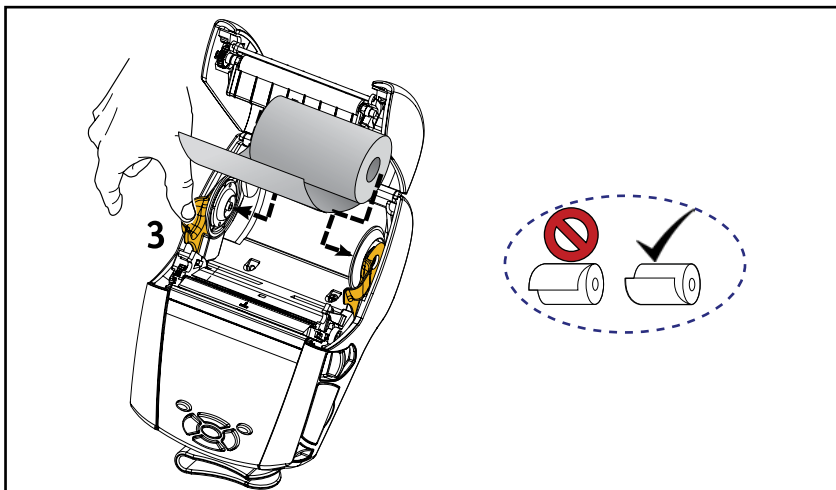

3. If you plan to use the printer in Tear-Off mode, close the media cover as shown below.

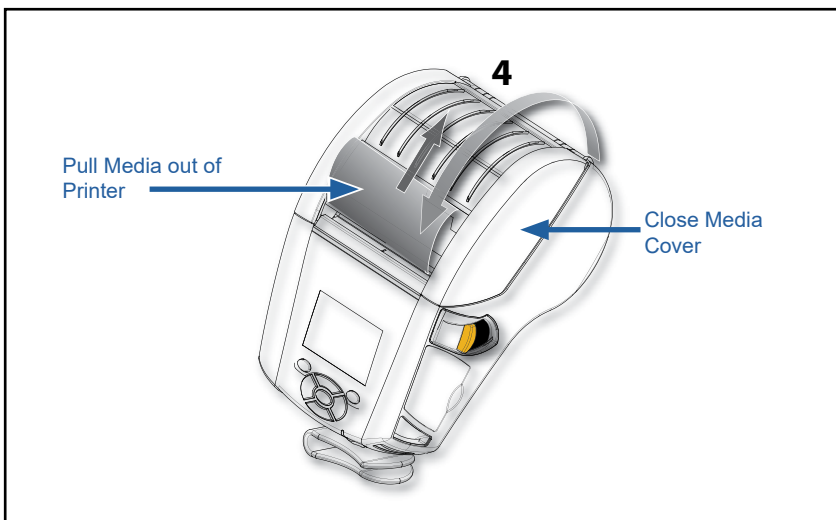

Note • Refer to the Programming Guide (P1099958-005) for information on changing the setting to adjust the media feed length via a Set-Get-Do (SGD).

Loading Media in Peel-Off Mode

If using the printer in Peel-Off mode:

1. Peel a few labels off the media and load the roll described previously (Figure 11).
2. See Figure 12. Push the peeler lever forward (3) to release the peeler bail (4) into the Up position.
3. Close the media cover to lock the peeler bail in place. The media will feed between the peeler bail and platen.

Figure 12 • Activating Peeler Bar (ZQ620 Plus Shown)

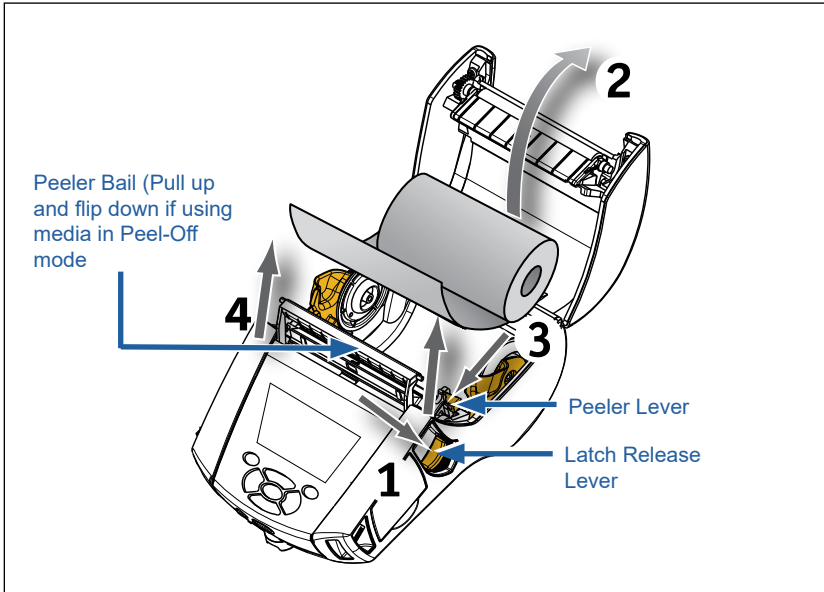

4. Turn the printer on, or press **FEED** on the front if the printer is already on.

To disengage the peeler bail:

1. Open the media cover as previously described. The peeler bail will automatically return to the Up position.
2. Press straight down on the peeler bail to lock the cover in its original home position.

ZQ6 Plus Healthcare Printers

The ZQ6 Plus Healthcare 2” and 3” printers are designed to meet the specific and unique needs of the healthcare environment. The healthcare application is based on the ZQ610 Plus and ZQ620 Plus printers primarily for barcode label printing, but also retaining the ZQ6 Plus’s ability to print receipts.

The ZQ610 Plus and ZQ620 Plus Healthcare printers also offer a few key enhancements to these existing printers:

- Provide printers with distinctive white and blue healthcare colors and performance plastics that are disinfected with the common cleaners used in hospitals.
- Leverage the technology advancements made on the ZQ6 Plus platform, such as new LCD display, 802.11ac/BT4.1 dual radio, NFC, QR code.

Figure 13 • ZQ620 Plus Healthcare Printer



Since the ZQ610 Plus and ZQ620 Plus Healthcare printers are based on the ZQ610 Plus and ZQ620 Plus platform, they are designed to be direct thermal printers which support variable print widths. They will provide a print experience compatible to the ZQ610 Plus and ZQ620 Plus, specifically in the following areas:

- Supports the same barcodes, barcode quality, and visual print quality.
- Offer equal wireless performance in terms of range, reliability, and speed.
- Compatible with all ZQ6 Plus accessories, but they do have a separate IEC60601 AC adapter exclusive to Healthcare printers.

The ZQ6 Plus Healthcare printers are designed and tested to withstand constant cleaning for the life of the printer.



Important • For detailed information on cleaning the Healthcare printers, refer to the Guide to Disinfecting and Cleaning Zebra Healthcare Printers (p/n P1066640-002) at zebra.com/support.

Operator Controls

The ZQ6 Plus printers come equipped with a keypad control panel and a color LCD graphical user interface. The standard control panel is illustrated in Figure 14. The LCD interface allows easy display and selection of many printer functions.

Standard Control Panel

The standard control panel has multiple control buttons and two multipurpose indicators:

- The **POWER** button turns the printer on and off.
- The **FEED** button advances a length of media which is determined by the type of media being used. Label media advances to the next gap or bar sense marker. Journal (plain) media advances by a length determined by the printer's software.
- **LEFT**, **RIGHT**, **UP**, and **DOWN** arrow navigation buttons allow you to scroll between functions on the LCD user space. (The Navigation Buttons do not apply to the Status Bar and Navigation Bar.)
- The **ENTER** button allows you to select the desired function highlighted on the LCD interface and is indicated by the word OK.
- Two software defined function keys allow you to select a function listed on the navigation bar.

Figure 14 • Control Panel



POWER Button

Press to turn unit on. There will be an approximate 20 second boot-up time. Press for 3 seconds to turn unit off.

FEED Button

Press to advance a blank label or a software-determined length of journal media.

Normal Boot-up LED Behavior

1. Press **POWER** (on/off) to turn the printer on.
2. When **POWER** is released, the **POWER** ring will blink as the printer boots up.
3. When the boot-up sequence is complete, the power ring will stop blinking and remain steadily lit. The color of the power ring depends on the charge status.

Sleep Mode LED Behavior

1. Pressing **POWER** for less than 3 seconds will put the printer in Sleep mode.
2. During Sleep mode, the **POWER** LED will slowly pulse either green, amber, or red depending upon whether or not the printer is charging successfully.

Shutdown Behavior

1. Press **POWER** for approximately 3 seconds to turn the printer off.
2. SHUTTING DOWN will appear on the LCD prior to the printer shutting down.









Figure 15 • Printer Shutdown



Power LED Ring Behavior

The **POWER** button is surrounded by a three-color (green, amber, red) LED ring. The **POWER** LED ring will:

- Blink once per 2 seconds green/amber/red during boot-up.
- Display solid green when the printer is fully charged while on or off.
- Pulse green to indicate Sleep mode and not charging.
- Stay solid amber to indicate charging while on or off.
- Pulse amber to indicate charging while in Sleep mode.
- Stay solid red to indicate an unhealthy charging or charged battery when not in Sleep mode (either on or off).
- Flash red twice per second indicating a charge fault.
- Pulse red to indicate unhealthy charging or charged battery when in Sleep mode.

	Blink green/amber/red during boot-up
	Power On/Charged Battery
	Pulse green Sleep Mode/Not Charging
	Power On/Battery Charging
	Charging in Sleep Mode
	Charging/Charge Complete (Unhealthy)
	Charging/Charge Complete (Unhealthy/Sleep Mode)
	Charge Fault

LCD Control Panel

The color LCD control panel allows you to view the status of the ZQ6 Plus printers and have access to various printer alerts and messages. It also has multi-directional keys that allow navigation and selection of menu options affecting printer functions. These keys allow scrolling through the various options and settings. The **OK** button allows selection of the option or function displayed on the screen.

The top of the screen has a row of status icons, or a Status Bar, which indicate the state of various printer functions. The Status Bar is located above the Status Screen (Figure 16) along with a Navigation Bar. The Status Screen is the default display and is shown at power up. After navigating, the printer automatically returns to this screen after a short delay.

Figure 16 • LCD Control Panel

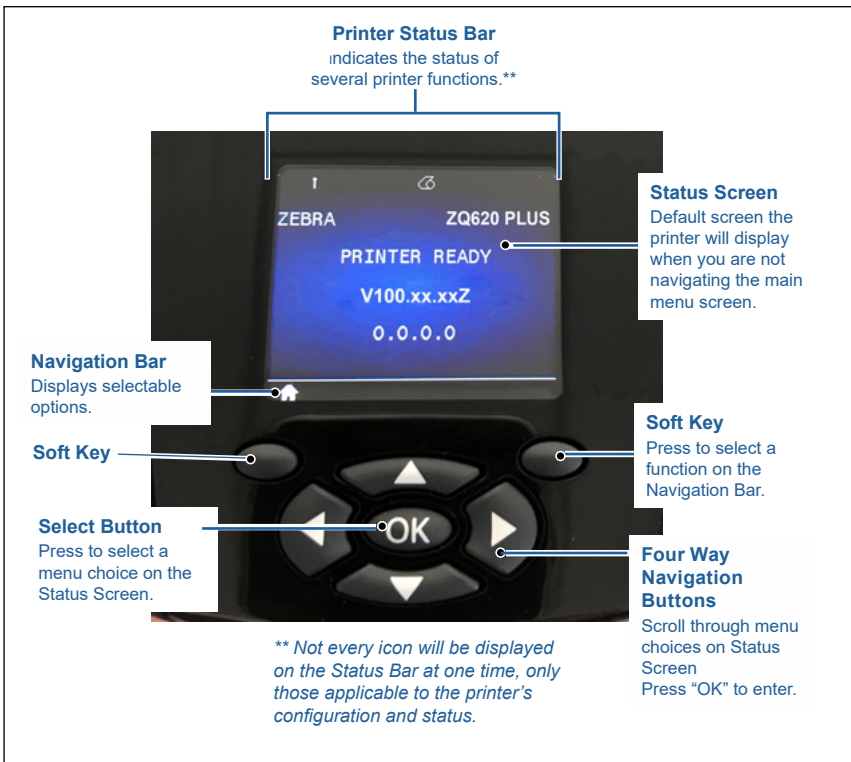

Status Bar Icons



Indicates Bluetooth connection status. The icon blinks to show that the printer is receiving label data via Bluetooth, and is **solid blue** when a link is established. This icon appears only on printers with the Bluetooth wireless option installed.



Indicates that the printer is connected to a radio network via 802.11 protocols. The antenna icon will blink with no signals when looking for an access point. One set of solid signals with a blinking antenna indicates WLAN is associated and attempting authentication. Two sets of solid signals and a solid antenna indicate the printer is successfully connected to the WLAN.

The icon and two parentheses blink to show the printer is receiving printer data via WLAN. The four bars  indicate the strength of the WLAN connection to the access point. These icons appear only with the 802.11 radio installed, such as one **solid yellow** bar, two **solid green** bars, three **solid green** bars, and four **solid green** bars.



The Ethernet icon **blinks green** when the printer receives label data via an Ethernet connection, and **solid green** when connected. It will not be displayed on the status bar when the Ethernet is inactive. This icon appears only when the Ethernet option is installed and the printer is docked the Ethernet cradle.



The Data icon indicates data being sent to the printer, such as the icon **blinks green** when there is a label data transmission via the serial or USB ports. It will be **solid green** when the parser is locked.



The Media Out icon **blinks red** when there is no media in the printer and will appear solid white when there is media in the printer.



The Head Latch icon indicates if the media cover is closed or not properly latched. It appears unlocked and **blinks red** if open and will not appear if the cover is closed.



The Error icon displays and **blinks red** when an error condition exists. The icon will not display if no printer error exists. Since there are separate icons for Media Out and Head Latch Open, these two alerts do not apply to the Error icon.



The Battery Charge Level icon indicates the reported state of charge from the battery pack. In a non-charging state, four **solid green** bars indicates the battery level is greater than 80%. Three **solid green** bars indicate if the battery level is less than or equal to 80% but greater than 60%. Two **solid yellow** bars indicates if the level is less than or equal to 60% but greater than 40%. One **solid red** bar indicates if the battery level is less than or equal to 40% but greater than 20%. Zero bars (**solid red** battery outline) indicates if the level is less than or equal to 20%.



As the battery charges, a lightning bolt appears in the battery icon indicating charging is taking place. When the battery is charging and fully charged, four **blinking green** bars will display. When the battery is charging and the level is greater than 80%, the battery icon will alternate between four bars and three **blinking green** bars. When the battery is charging and the level is less than or equal to 80% but greater than 60%, the icon will alternate between three bars and two **blinking yellow** bars. When the battery is charging and the level is less than or equal to 60% but greater than 40%, the icon will alternate between two bars and one **blinking red** bar. When the battery is charging and the level is less than or equal to 40% the icon will alternate between one bar and zero **blinking red** bars.

Home Menu Screen

The printer's control panel includes a display where you view the printer status or change its operating parameters. After the printer completes the power-up sequence, it moves to the Idle Display screen (Figure 17). This screen includes the printer's current status, information such as firmware version and IP address, and a Home Menu shortcut.

Press **LEFT ARROW** to go to the Home Menu screen which displays graphical parameter options including Settings, Tools, Network, Battery, Language, Sensors, Ports, and Bluetooth (Figure 17). These options allow you to view the printer's status or change its operating parameters.

Figure 17 • Home Menu Screen



You can move between icons using the four-way arrow buttons. When an icon is highlighted (for example, Settings), its description will be displayed in the middle of the navigation bar (see arrow in Figure 17), and is selected by pressing **OK**. This takes you to the first screen (such as Darkness) under that parameter, which gives you status information specific to that option (Figure 18). To navigate to the next screen, press the **RIGHT ARROW**.

Figure 18 • Parameter Menu Screen Example







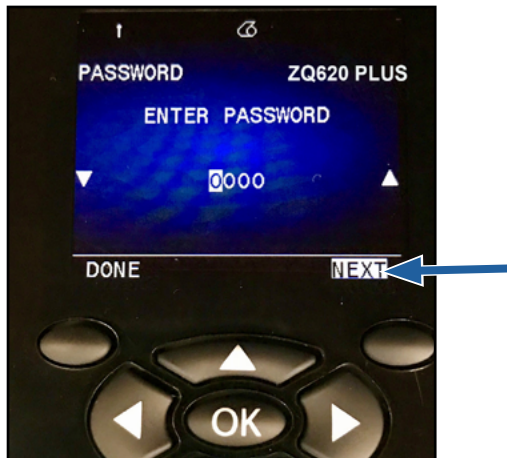



Some parameter settings, like Darkness, have a scroll option to view multiple setting choices. This option is identifiable by the presence of up and down scrolling arrows located on either side of the display (Figure 18). Press the **UP ARROW** and **DOWN ARROW** on the keypad to scroll through a menu's options. In some cases, further actions will appear on the right side of the status screen (see arrow in Figure 19). Press the **RIGHT SOFT KEY** to initiate said action.

Figure 19 • Scrolling Menu



Click the **LEFT SOFT KEY** to exit the screen and again to return to the Home Menu screen to choose a different parameter.

Home Screen Icons and Parameters

Icon	Parameter
	See Settings menu in “Appendix D”
	See Tools menu in “Appendix D”
	See Network menu in “Appendix D”
	See Battery menu in “Appendix D”
	See Language menu in “Appendix D”
	See Sensors menu in “Appendix D”
	See Ports menu in “Appendix D”
	See Bluetooth menu in “Appendix D”

Alert Messages

The ZQ6 Plus printers display various blinking alerts, such as Media Out, Media Cover Open, or Battery Low. These alerts are separated into Errors, Warnings and Info with different color mapping used to differentiate one from the other (see the following table).

	INFO	WARNING	ERROR
Foreground Color (Text)	White	Black	White
Background Color	Green	Yellow	Red

Figure 20 • Error Alert Message









You respond to alerts by pressing one of the soft keys. Once the condition causing the alert is resolved (for example, loading media), the alert message will clear. (Go to “Appendix G” for a complete list of alerts for the ZQ6 Plus printers.)

Buttons

You can use the ZQ6 Plus's multi-button interface to run the following power-up and runtime sequences.

Power-Up Sequences

Seq. #	Function	Keys	Button
1	Two Key Report	Hold down FEED while pressing POWER	 
2	Revert to Factory WML	Hold down the UP and DOWN ARROWS while pressing POWER	 
3	Forced Download	Hold down both SOFT KEYS while pressing POWER	 
4	Turn printer On or Off or to enter Sleep mode	POWER	



Note • You may need to revert to factory WML if some features were turned off in the custom WML, and there is a need to get to the “full” menu. Also, if a change was made that caused the WML system to lock up, reboot to restore functionality temporarily.



Note • A forced download is when the printer is powered up in a mode wherein it is running only the code that allows for firmware downloads to happen.

Runtime Sequences without LED Flashes

Seq. #	Function	Keys	Button
1	Media Feed	FEED	
2	Wake, if in Sleep mode	Any button	

Sleep Mode

The Sleep mode feature is a way the printer conserves battery life whereby the printer automatically goes into a sleep state after 20 minutes of inactivity. When the printer is in this state, no content is displayed on the LCD and no backlight. The printer indicates Sleep mode by a slow blinking green LED ring around the **POWER** button.

If **POWER** is pressed for less than 3 seconds, the printer goes into Sleep mode. The printer will indicate this on the LCD in the form of a Sleeping info message (Figure 21), that disappears when the display turns off.

Figure 21 • Sleep Mode Info Message



In Sleep mode, the green LED ring around the **POWER** button will pulse approximately once every 3 seconds. Press any button to wake the printer from Sleep mode. Other power management features of the ZQ6 Plus printers include Wake on Bluetooth and Wake on WiFi (the printer exits Sleep mode due to data exchanged via Bluetooth 4.1 or a network message received over WiFi). The printer does not enter Sleep mode when docked in an Ethernet cradle.

To enable or disable Sleep mode, send the `power.sleep.enable` command to the printer using Zebra Setup Utilities (ZSU) and set it to On (default) or Off. To set the time after which the printer will enter Sleep mode, send the `power.sleep.timeout` (in seconds) to the printer using the ZSU.

Adaptive Print Performance

The ZQ6 Plus printers use PSPT PrintSmart Gen 2 technology which adapts to your print conditions such that print quality is not sacrificed. When the printer sees environmental conditions such as state of charge, battery health, cold temperature extremes, or high density printing, the printer will adjust print performance to preserve battery function and allow printing to continue. This may affect the speed and sound of printing but not the print quality.

Draft Mode

You can configure the printer to print in Draft mode via SGD command `media.draft_mode` (default is Off), which optimizes the printer for text-only printing. While in Draft mode, print speed increases from 4–5 ips (inches per second) with an approximate 22% reduction in optical density.



Note • For an explanation and a list of all SGD commands, refer to the Programming Guide (p/n P1099958-005) at zebra.com/support.

Verify the Printer is Working

Before you connect the printer to your PC or mobile computer, make sure the printer is in proper working order. You can do this by printing a configuration label using the Two Key method. If you can't get this label to print, go to Troubleshooting.

Printing a Configuration Label

1. Turn the printer off.
2. Load the media compartment with journal media (media with no black bars or gaps on the back).
3. Press and hold **FEED**.
4. Press and release **POWER** and keep **FEED** pressed.
5. When printing starts, release **FEED**.

The unit will:

- Print a line of interlocking “x” characters to ensure all elements of the print head are working.
- Print out the version of software loaded in the printer.
- Print the report.

The report indicates model, serial number, baud rate, and other detailed information on the printer's configuration and parameter settings. (See Troubleshooting for sample printouts and further instruction on how to use the configuration label as a diagnostic tool.)

Connecting the Printer

The printer must communicate with a host which sends data to be printed. ZQ6 Plus printers communicate in four basic ways:

1. By cable, either RS-232C or USB 2.0
Windows drivers that support printing via Serial, USB, and the network are included in the Zebra Designer Driver which can be downloaded from zebra.com/drivers.
2. By means of a wireless LAN (Local Area Network) per 802.11 specifications (optional)
3. By means of the Ethernet when docked on the Ethernet cradle.
4. By means of a Bluetooth short range radio frequency link

WinMobile®, Blackberry®, and Android devices use the standard Bluetooth protocol.

ZQ6 Plus printers are compatible with iOS devices, therefore printing via Bluetooth to an Apple device is possible.



Cable Communication



Caution • The printer should be turned off before connecting or disconnecting a communications cable.

The ZQ6 Plus printers can communicate by cable; the specific cable supplied with your printer will vary with the host device and your model printer.

RS-232C Communications

The 14-pin serial connector on your communications cable plugs into the serial communications port on the side of the printer. ZQ6 Plus printers also have a USB port.

USB Communications

The small 5-pin connector on the USB cable plugs into the printer. The connectors are keyed to assure correct alignment; do not try to force the cable if it does not plug in.

Figure 22 • Communications Options

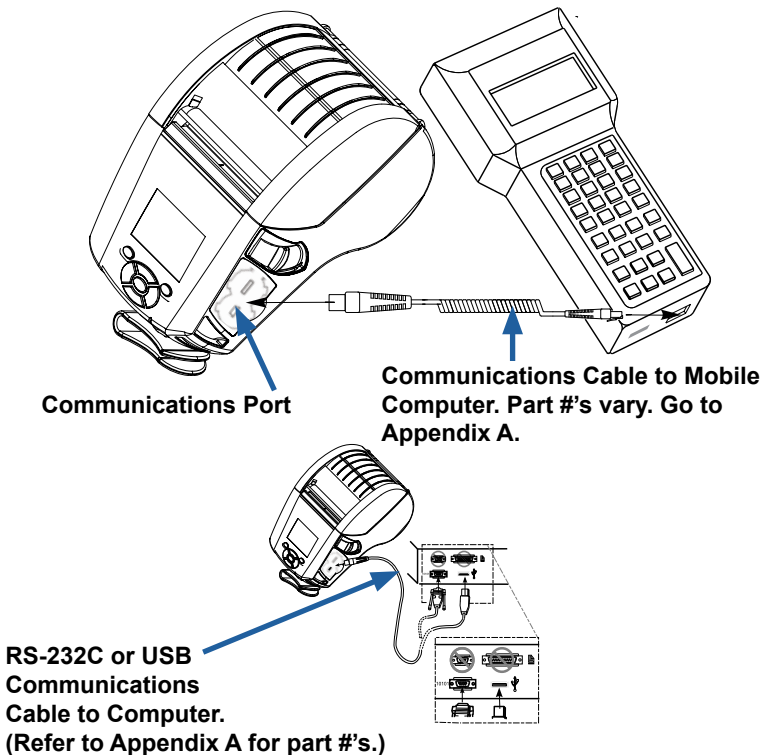

The other end of the cable must be plugged into the mobile computer (Figure 22), or to a serial or USB port on a computer. The ZQ6 Plus printers are configured with the USB Open HCI interface driver allowing it to communicate with Windows-based devices.

Zebra Designer Driver uses Windows drivers that support printing via Serial, USB and the network. Mobile computers and other communication devices may require you to install special drivers to use the USB connection. Go to zebra.com/support for further details.

Providing Strain Relief for Communications Cable

When connecting either a USB or RS-232 communications cable to the printer permanently:

1. Access the communications port on the side of the printer next to the latch release lever.
2. Plug the connector into the appropriate port and align the plastic locking cap with the cutouts shown in Figure 22.
3. Rotate the locking cap clockwise to lock the cable in place. (Turn counterclockwise to unlock the cable.)

Once locked in place, this provides strain relief for the cable and will prevent the cable from disconnecting from the printer.



Note • Only one cable can be present in the USB/RS-232 communications port at a time for strain relief purposes.

Installing Drivers and Connecting to a Windows-Based Computer

To use your printer with a Microsoft Windows-based computer, you must first install the correct drivers.



Important • You may connect your printer to your computer using any available connections. However, do not connect any cables from your computer to the printer until you are instructed to do so. If you connect them at the wrong time, your printer will not install the correct printer drivers. To recover from incorrect driver installation, see “What to Do If You Forget to Install Printer Drivers First”.

Installing the Drivers

Follow these steps to install the correct drives.

1. Navigate to zebra.com/drivers.
2. Click **Printers**.
3. Select your printer model.
4. On the printer product page, click **Drivers**.
5. Download the appropriate driver for Windows.

The driver executable file (such as `zd86423827-certified.exe`) is added to your Download folder.

6. Run the executable file and follow the prompts.

When the setup is complete, you may add specific printers (go to “Running the Printer Installation Wizard” on page 55).

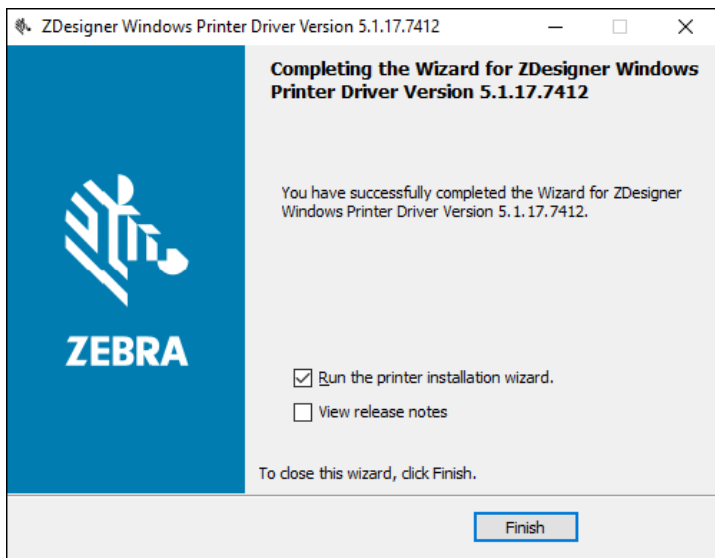

Running the Printer Installation Wizard

1. On the last screen of the driver installer, leave **Run the Printer Installation Wizard** checked, and then click **Finish**.

The printer driver wizard displays.

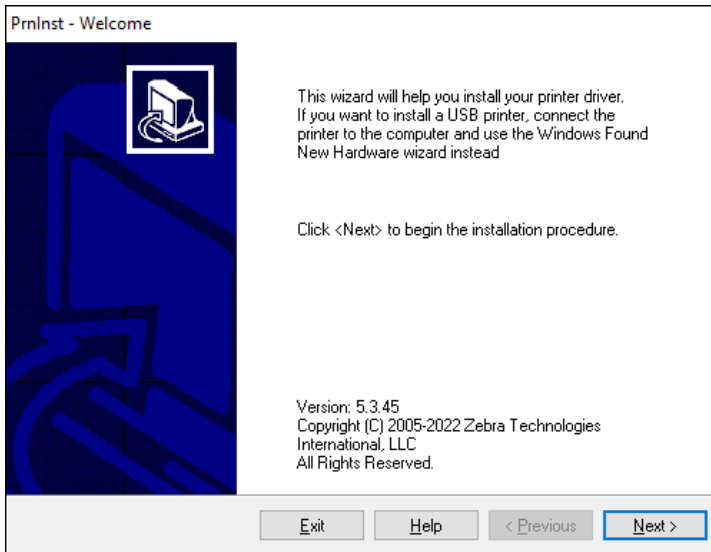

2. Click **Next**.

You are prompted to select an installation option.

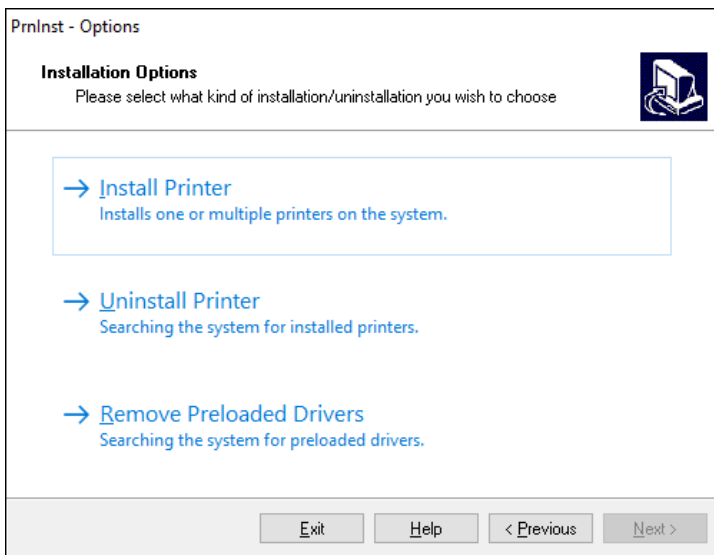

3. Click **Install Printer**.

The license agreement displays.

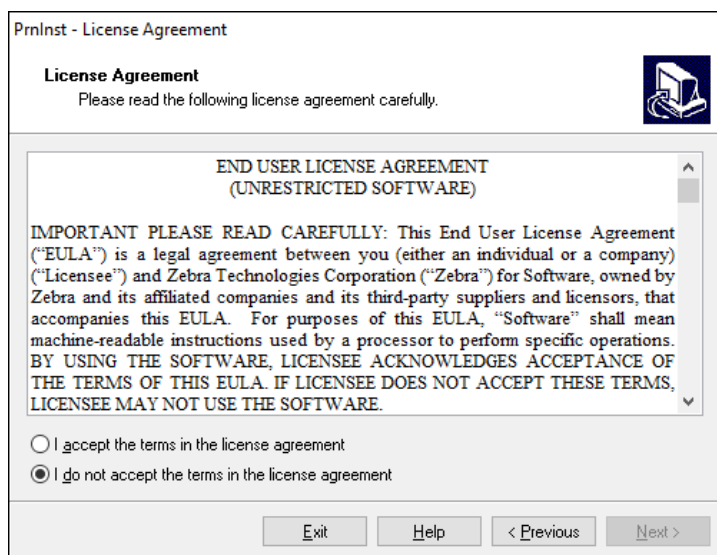

4. Read the important information and agree to the terms by selecting the **I Accept the Terms in the License Agreement** button. **Click Next.**

You are prompted to select a printer type. The model of the printer is located on the top next to the tear bar, or on the part sticker located underneath the printer.

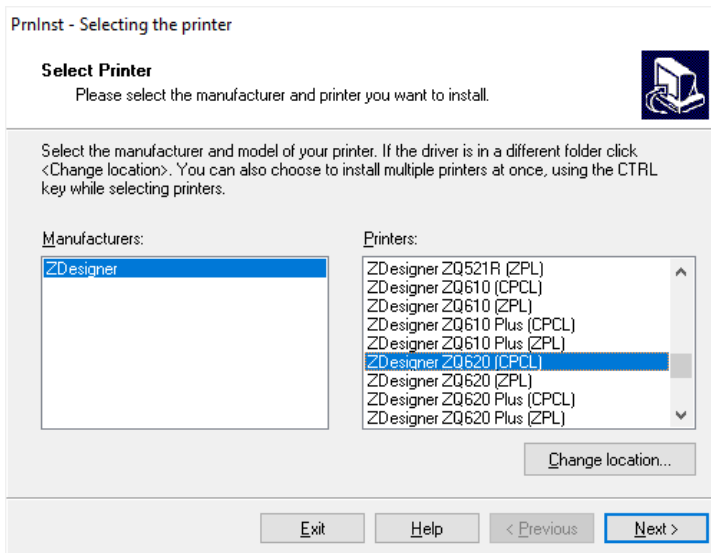

5. Click **Next.**

You are notified that the printer is already installed.

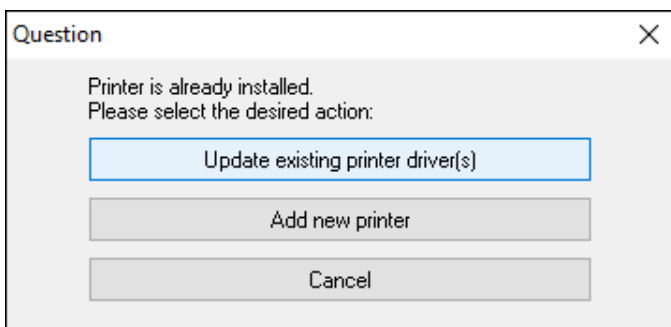

6. Click **Add new printer**.

You are prompted for a printer name, the port to which the printer will be connected, and the language for the printer display. In this example, select **USB002**.

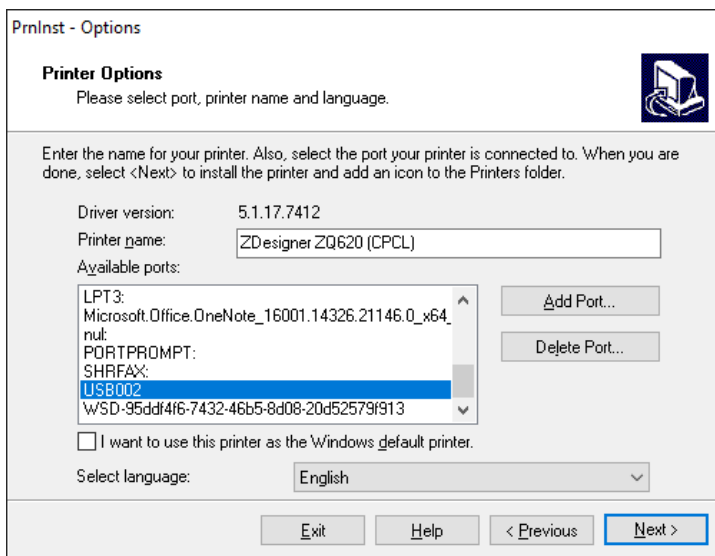

7. Click **Next**.

You are prompted to launch other setup wizards.

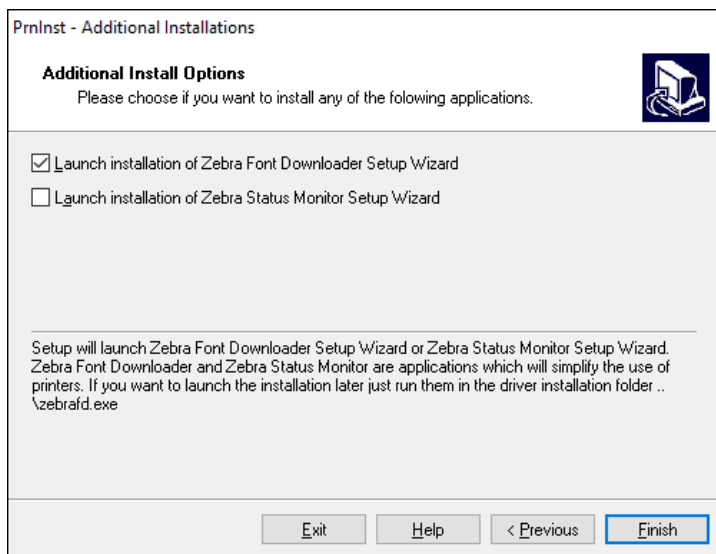

8. Click **Finish**.

After you install the drivers, connect the USB cord to the USB port on your printer (go to “USB Communications” on page 51).

As the printer boots up, your computer completes the driver installation and recognizes your printer. If you did not install the drivers first, see “What to Do If You Forget to Install Printer Drivers First”.

What to Do If You Forget to Install Printer Drivers First

If you plug in your Zebra printer before installing the drivers, the printer displays as an Unspecified device.

1. Follow the instructions in “Installing Drivers and Connecting to a Windows-Based Computer” on page 53.
2. Right-click on the Windows menu and select Device Manager.
 - Alternatively, enter Device Manger in the Windows search bar located in the Taskbar.

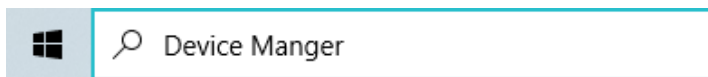

3. Click **Devices and Printers**

In this example, ZQ220 Plus is an incorrectly installed Zebra printer.

4. Find **Printers** from the list and select the arrow to expand the list.
5. Right-click on ZDesigner ZQ220 Plus (CPCL) to open the menu.

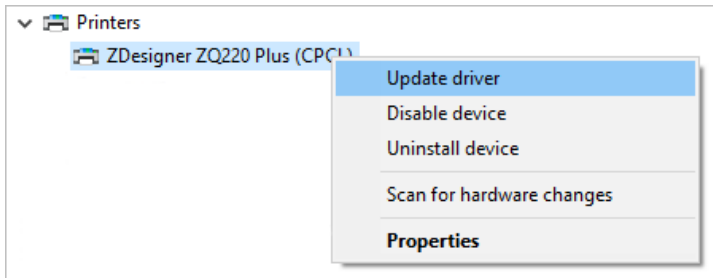

6. Click **Update Driver**.

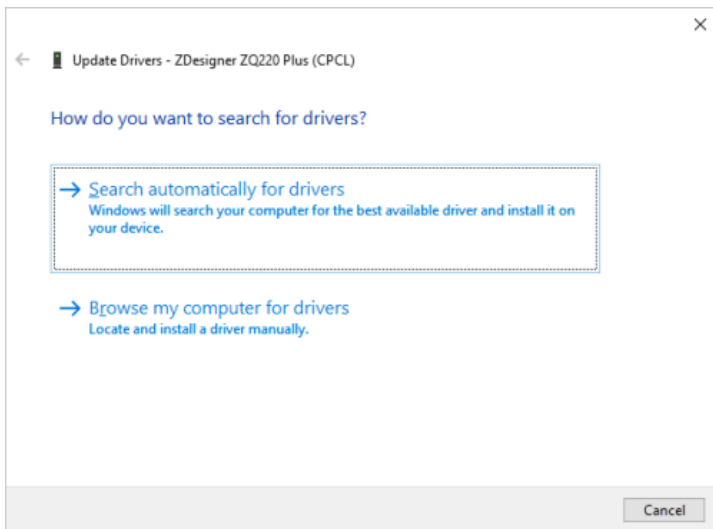

7. Click **Browse my computer for driver software**.

8. Click **Browse...** and navigate to the Downloads folder.

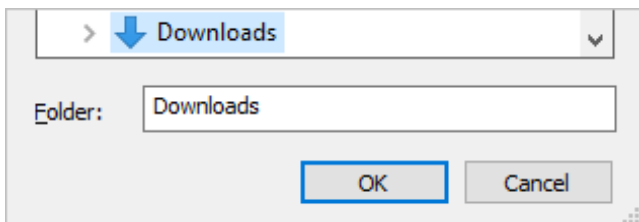

9. Click **OK** to select the folder.

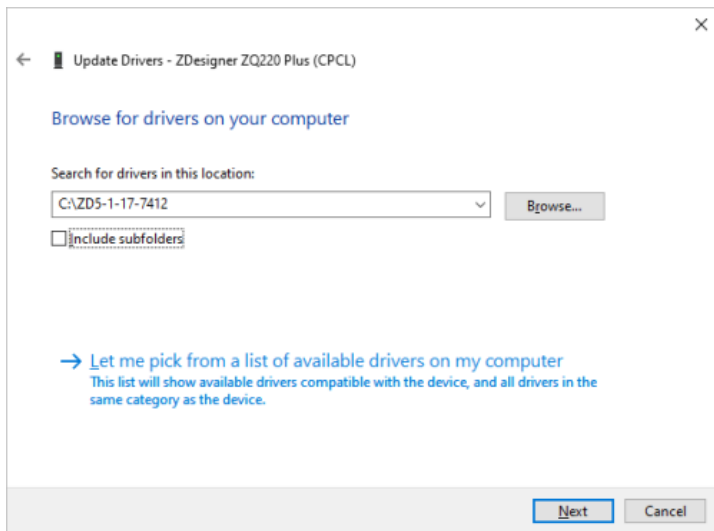

10. Click **Next**.

The device is updated with the correct drivers.

Connect to a Phone or Tablet

Download the free Zebra Printer Setup Utility app for your device.

- Android devices
- Apple devices

The applications support the following types of connectivity:

- Bluetooth Classic
- Bluetooth Low Energy (Bluetooth LE)
- Wired/Ethernet
- Wireless
- USB On-the-Go

For the User Guides for these printer setup utilities, go to zebra.com/setup.

Zebra Printer Setup Utilities

Before configuring your printer for use on a Local Area Network (LAN), you will need some basic information that will enable you to establish the network configuration for your printer. Zebra Setup Utilities (ZSU) provides a quick and easy way to configure your printers for a variety of purposes, including setting them up for wireless communications either on a Local Area Network (LAN) or using the international Bluetooth communications standard.

Once Zebra Setup Utilities is downloaded to your computer, attach the USB cable to the printer and computer as shown in Figure 22.

Go to zebra.com/support to download ZSU, and go to “Appendix H” on page 137 for details on navigating zebra.com).

Adding a Printer through Zebra Setup Utilities

If desired, use Zebra Setup Utilities to add printers to Windows using this procedure, after installing the drivers.

1. If necessary, install the Zebra Setup Utilities for Windows.
 - b. Go to zebra.com/setup and download Zebra Setup Utilities for Windows.
 - c. Run the zsu-xxxxxxx.exe file that you downloaded.
 - d. Follow the prompts in the IntallAwareWizard.
 - e. In the final screen of the wizard, click the checkbox next to Run Zebra Setup Utilities now, and then click Finish.
 - f. Follow the prompts in the System Prepare Wizard. If necessary, open the Zebra Setup Utilities program.
2. If necessary, open the Zebra Setup Utility program.

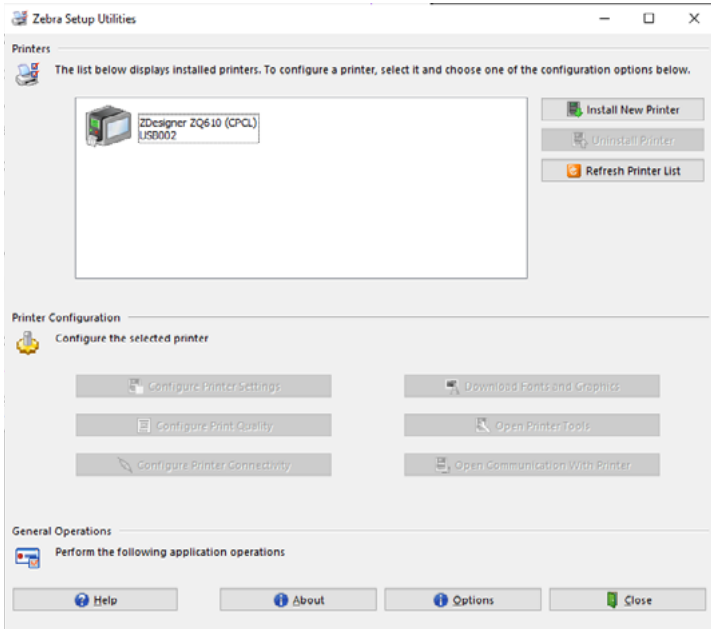

3. Click **Install New Printer**.

The printer driver wizard displays.

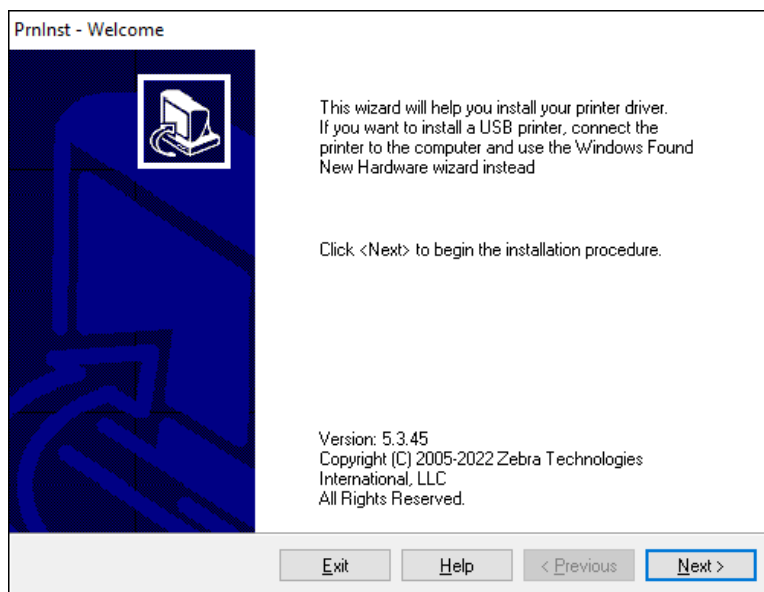

4. Click **Next**.

You are prompted to select an installation option.

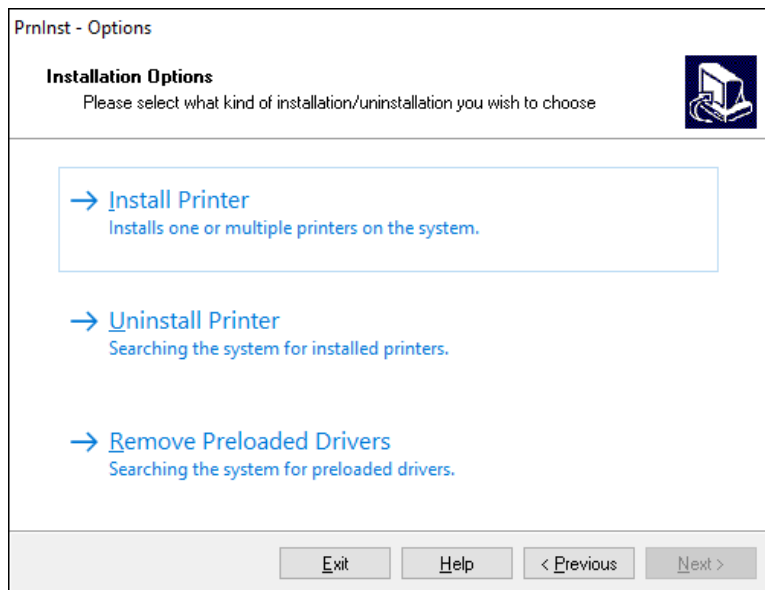

5. Click **Install Printer**.

You are prompted to select a printer type. The model type is located on top of the printer next to the tear bar, or on the part sticker located underneath the printer.

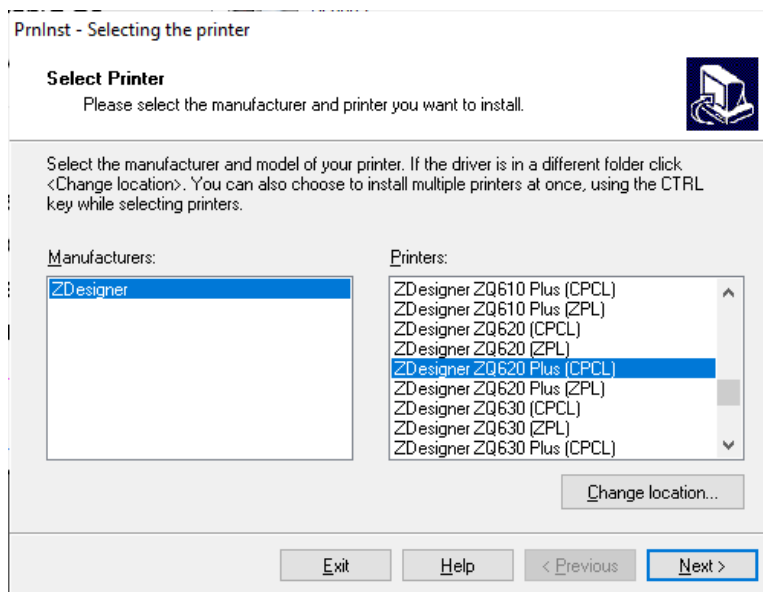

6. Click **Next**.

You are notified that the printer is already installed.

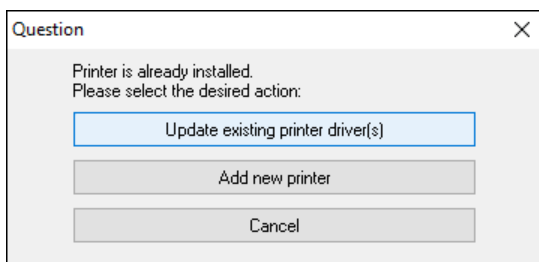

7. Click **Add new printer**.

You are prompted for a printer name, the port to which the printer will be connected, and the language for the printer display. In this example, click **USB002**.

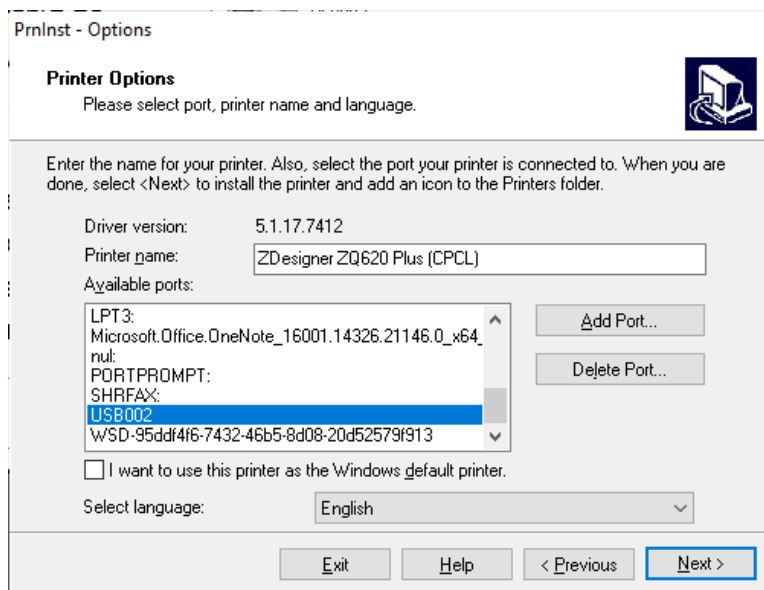

The screenshot shows the 'PrnlInst - Options' dialog box. At the top, it says 'Printer Options' and 'Please select port, printer name and language.' Below this, there is an instruction: 'Enter the name for your printer. Also, select the port your printer is connected to. When you are done, select <Next> to install the printer and add an icon to the Printers folder.' The 'Driver version' is 5.1.17.7412. The 'Printer name' field contains 'ZDesigner ZQ620 Plus (CPCL)'. Under 'Available ports', a list box shows several options, with 'USB002' selected and highlighted in blue. To the right of the list box are 'Add Port...' and 'Delete Port...' buttons. Below the list box is a checkbox labeled 'I want to use this printer as the Windows default printer.' The 'Select language:' dropdown menu is set to 'English'. At the bottom, there are four buttons: 'Exit', 'Help', '< Previous', and 'Next >', with 'Next >' highlighted in blue.

PrnlInst - Options

Printer Options
Please select port, printer name and language.

Enter the name for your printer. Also, select the port your printer is connected to. When you are done, select <Next> to install the printer and add an icon to the Printers folder.

Driver version: 5.1.17.7412
Printer name: ZDesigner ZQ620 Plus (CPCL)
Available ports:

- LPT3:
- Microsoft.Office.OneNote_16001.14326.21146.0_x64_nul:
- PORTPROMPT:
- SHRFX:
- USB002**
- WSD-95ddf4f6-7432-46b5-8d08-20d52579f913

I want to use this printer as the Windows default printer.

Select language: English

Exit Help < Previous **Next >**

8. Click **Next**.

You are prompted to launch other setup wizards.

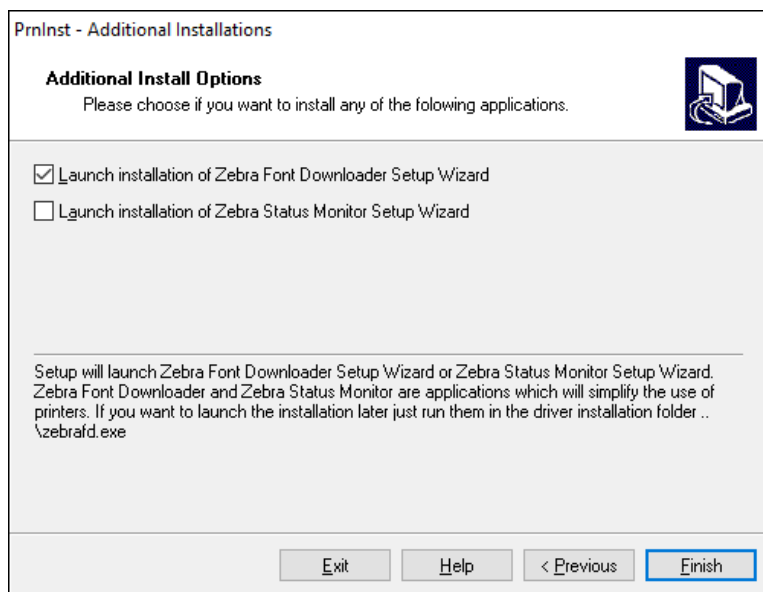

9. Check the desired options, and then click **Finish**.

The printer driver is installed. If you are prompted that other programs might be affected, click the appropriate option to continue.

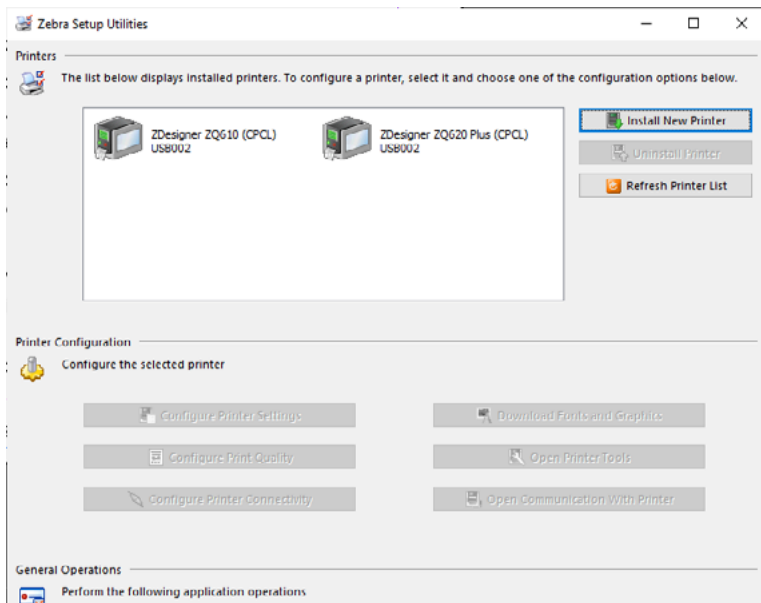

Wireless Communications with Bluetooth

Bluetooth is a worldwide standard for the exchange of data between two devices via radio frequencies. This form of point-to-point communication does not require access points or other infrastructure. Bluetooth radios are relatively low powered to help prevent interference with other devices running at similar radio frequencies. This limits the range of a Bluetooth device to approximately 10 m (32 ft). The default for the ZQ6 Plus is Class 2, but the range can be set to Class 1 via a SGD (`bluetooth.power_class`) to increase power. Both the printer and the device it communicates with must follow the Bluetooth standard.

Bluetooth Networking Overview

Each Bluetooth enabled ZQ6 Plus printer is identified by a unique Bluetooth Device Address (BDADDR). This address resembles a MAC address whereby the first three bytes are vendor, and the last three bytes are device (for example, 00:22:58:3C:B8:CB). This address is labeled on the back of the printer via a barcode for ease of pairing. (For the dual radio, the MAC address label only represents WiFi MAC address (Figure 23). To exchange data, two Bluetooth enabled devices must establish a connection. Bluetooth software is always running in the background, ready to respond to connection requests. One device (known as the client) must request/initiate a connection with another. The second device (the server) then accepts or rejects the connection. A Bluetooth enabled ZQ6 Plus printer will normally act as a follower creating a miniature network with the host device, sometimes referred to as a piconet. Discovery identifies Bluetooth devices that are available for pairing whereby the controller device broadcasts a discovery request and devices respond. If a device is not discoverable, the controller cannot pair unless it knows the BDADDR or has previously paired with the device. If both devices support Bluetooth 2.1 or higher, they will use Security Level 4 Secure Simple Pairing (SSP), a mandatory security architecture that features two association models: Numeric Comparison and Just Works (no user confirmation).

Bluetooth Security Modes

<p>Security Mode 1</p> <p>If a BT \geq 2.1 device is pairing with a BT \leq 2.0 device, it falls back to BT 2.0 compatibility mode and behaves the same as BT 2.0. If both devices are BT \geq 2.1, Secure Simple Pairing must be used according to the BT spec.</p>	<p>Security Mode 2</p> <p>If a BT \geq 2.1 device is pairing with a BT \leq 2.0 device, it falls back to BT 2.0 compatibility mode and behaves the same as BT 2.0. If both devices are BT \geq 2.1, Secure Simple Pairing must be used according to the BT spec.</p>	<p>Security Mode 3</p> <p>If a BT \geq 2.1 device is pairing with a BT \leq 2.0 device, it falls back to BT 2.0 compatibility mode and behaves the same as BT 2.0. If both devices are BT \geq 2.1, Secure Simple Pairing must be used according to the BT spec.</p>
--	--	--

<p align="center">Security Mode 4: Simple Secure Pairing</p> <p>Simple Secure Pairing: a new security architecture introduced supported in BT \geq 2.1. Service-level enforced, similar to mode 2. Mandatory when both devices are BT \geq 2.1. There are four association models currently supported by mode 4. Security requirements for services must be classified as one of the following: authenticated link key required, unauthenticated link key required, or no security required. SSP improves security through the addition of ECDH public key cryptography for protection against passive eavesdropping and man-in-the-middle (MITM) attacks during pairing.</p>
--

Numeric Comparison	Just Works
<p>Designed for situation where both devices are capable of displaying a six-digit number and allowing you to enter “yes” or “no” response. During pairing, you enter “yes” if number displayed on both devices matches to complete pairing. Differs from the use of PINs in legacy (BT \leq 2.0) pairing because the number displayed for comparison is not used for subsequent link key generation, so even if it is viewed or captured by an attacker, it could not be used to determine the resulting link or encryption key.</p>	<p>Designed for situation where one (or both) of the pairing devices has neither a display nor keyboard for entering digits (for example, Bluetooth headset). It performs authentication step 1 in the same manner as numeric comparison, but you cannot verify that both values match, so MITM (man-in-the-middle) protection is not provided. This is the only model in SSP that does not provide authenticated link keys.</p>

Each mode, except for Just Works, has Man-In-The-Middle (MITM) protection, meaning no third device can view the data being passed between the two devices involved. The SSP mode is usually negotiated automatically based on the capabilities of both the controller and follower. Lower security modes can be disabled via the `bluetooth.minimum_security_mode` SGD. The `bluetooth.minimum_security_mode` SGD sets the lowest security level at which the printer will establish a Bluetooth connection. The printer connects at a higher security level if requested by the controller device. To change the security mode and security settings in the ZQ6 Plus printers, use Zebra Setup Utilities.

Bluetooth Minimum Security Modes

	BT Version of Controller Device (>2.1)
<code>bluetooth.minimum_security_mode=1</code>	Secure Simple Pairing Just Works/Numeric Comparison
<code>bluetooth.minimum_security_mode=2</code>	Secure Simple Pairing Just Works/Numeric Comparison
<code>bluetooth.minimum_security_mode=3</code>	Secure Simple Pairing Numeric Comparison
<code>bluetooth.minimum_security_mode=4</code>	Secure Simple Pairing Numeric Comparison
<code>bluetooth.bluetooth_PIN</code>	Not Used



`bluetooth.minimum_security_mode` **sets the lowest security level at which the printer will establish a Bluetooth connection. The printer connects at a higher security level if requested by the controller device.**

The ZQ6 Plus printers also feature bonding for Bluetooth. The printer caches pairing info so devices stay paired through power cycles and disconnects. This eliminates having to pair on every connection.

The `bluetooth.bonding` SGD is on by default.



Note • For detailed information on Bluetooth, refer to the Bluetooth Wireless User Guide (P1068791-05) at zebra.com/support.

In addition, the ZQ6 Plus printers support passive Near Field Communication (NFC) technology. Using the Print Touch feature located on the side of the printer, you can automatically pair with a handheld device that supports NFC technology. The NFC tag has the printer's BDADDR encoded in a URL on the tag. Simply touching the NFC handheld device to the Print Touch icon on the printer will connect and pair the handheld device to the printer.

WLAN Overview

ZQ6 Plus printers are optionally equipped with a dual radio that uses the industry standard 802.11 protocols and Bluetooth 4.1. They have the FCC ID number on the serial number label on the back of the unit.

- ZQ6 Plus Wireless Network Printers with the Zebra 802.11 WLAN radio module are identified by the text “Wireless Network Printer” on the serial number label on the back of the printer.
- These printers allow communication as a node within a wireless local area network (WLAN). Communication methods to the printer vary with each application.

More information and LAN configuration utilities are included in the ZebraNet Bridge Enterprise™ program (version 2.8 and later).

Zebra Setup Utilities (ZSU) is used to configure WLAN communications settings. Both ZebraNet Bridge Enterprise and ZSU may be downloaded from zebra.com/support.

Figure 23 • BT/WLAN Communications

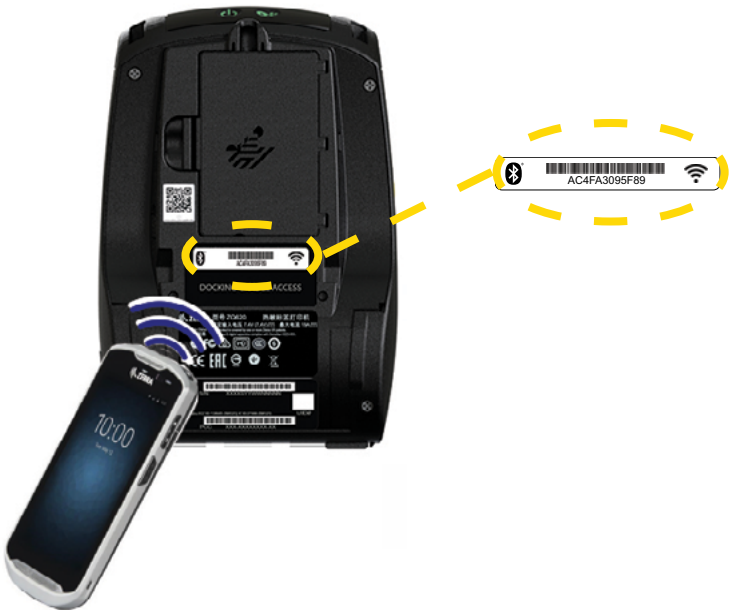

Setting Up the Software

ZQ6 Plus printers use Zebra's CPCL, ZPL or EPL Programming languages that were designed for mobile printing applications. CPCL and ZPL are described in the ZPL Programming Guide (p/n P1014152-017EN) and ZPL II Programming Guide (P1099958-005) available at zebra.com/support. Use ZebraDesigner, Zebra's Windows-based label creation program that uses a graphical interface to create and edit labels in either language (go to zebra.com/zebradesigner).

Designing Labels

The following examples provide guidelines for designing labels for the ZQ6 Plus printers, specifically for Gap Media, Black Bar Media and Journal Media. The illustrations for each media type define recommended tolerances, keep-out zones and safe printing zones designed to avoid any vertical registration issues during printing. Dimensions are determined based on product registration capabilities and Zebra-recommended media tolerances.

Figure 24 • Gap Media

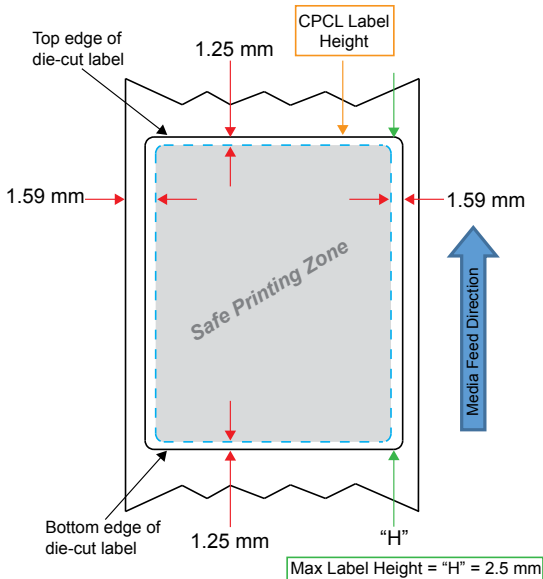

Figure 25 • Journal Media

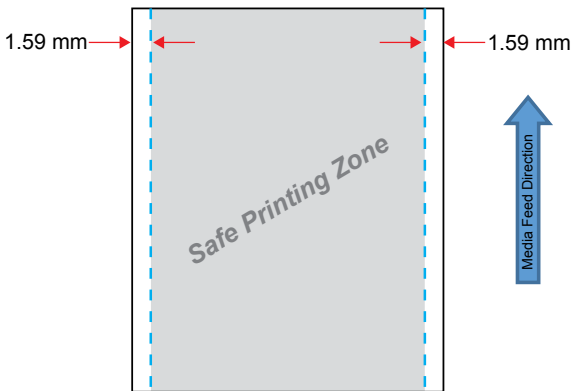
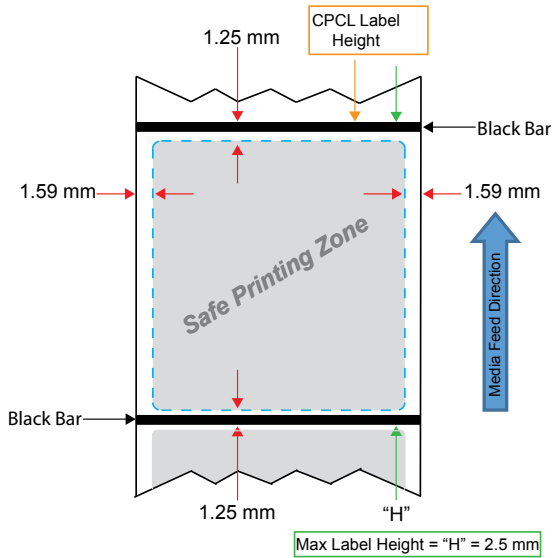

Figure 26 • Black Bar Label Media



Using Pre-Printed Receipt Media

ZQ6 Plus printers support alignment of pre-printed receipts by using the out-of-paper sensor located near the printhead.

Black Mark Dimensions (Receipt Media)

The reflective media black marks (or black bar/marks) should extend past the center line of the roll on the front side of the paper.

- Minimum mark width: 15 mm (0.59 in.) perpendicular to the edge of the media, and centered within the width of the roll.
- Mark length: 4.8 – 6.0 mm (0.19 – 0.24 in.) parallel to the edge of the media.

Label Areas

The media/black bar sensor detects the dark, pre-printed bar on the media, so a path in the center of the paper must be kept free of dark, pre-printed graphics.



Note • Dark, pre-printed graphics refer to any symbols, barcodes, text, and/or colored areas that were manufactured as part of the receipt paper rolls.

Figure 27 • Label Areas

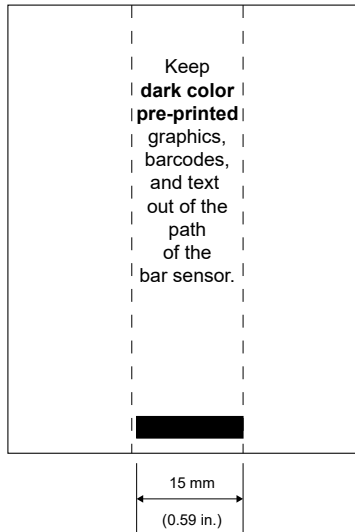

Label Design Examples

This section shows examples of labels with and without problems.

Figure 28 • Label Design Examples

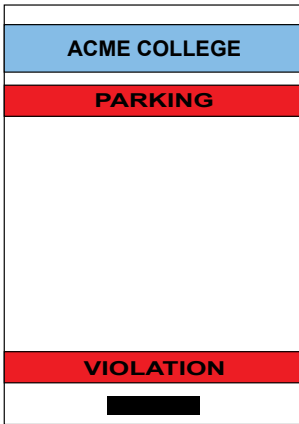

PROBLEM LABEL DESIGN

The dark color, pre-printed text and graphics are in the path of the black bar at the bottom of the receipt.

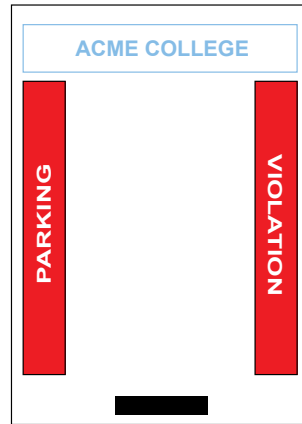

GOOD LABEL DESIGN

The center path to the black bar is free of dark color, pre-printed text and graphics.

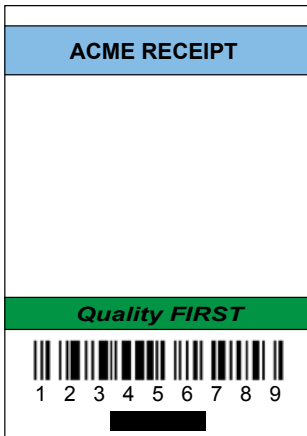

PROBLEM LABEL DESIGN

The dark color, pre-printed text and graphics are in the path of the black bar at the bottom of the receipt.

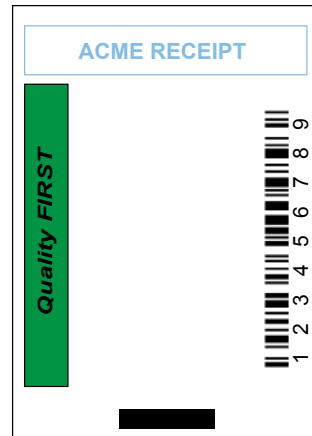

GOOD LABEL DESIGN

The center path to the black bar is free of dark color, pre-printed text and graphics.



Note • Complete information on using pre-printed receipt paper can be found in the FORM command in the CPCL Programming Guide (P1073699-001). Go to zebra.com/manuals.

Keep-Out Areas

At times, incomplete printing of text and/or graphics appear because minimum margins are not provided during label design. The recommended minimum margins, or Keep Out Areas are shown in Figure 29.

Figure 29 • Keep Out Areas

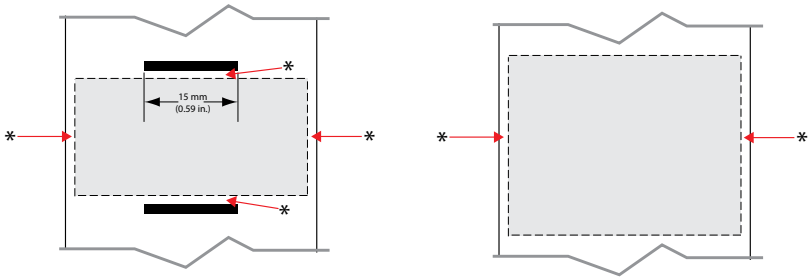

Receipt Paper with Black Bars

* Maintain a minimum "keep out area" of 1.59 mm (1/16 in.) from the two outer edges of the paper roll and from the black bars.

Continuous Receipt Paper (without Black Bars)

* Maintain a minimum "keep out area" of 1.59 mm (1/16 in.) from the two outer edges of the paper roll.



Note • The length of each Continuous receipt is determined by the data sent to the printer.

Near Field Communication (NFC)

Devices using NFC may be **active** or **passive**. A passive device, such as a ZQ6 Plus series printer with an NFC tag, contains information that other devices read, but the NFC tag does not read any information itself. An active device, such as a smartphone, can read the information on the printer's NFC tag, but the tag itself only transmits data to authorized devices.

Figure 30 • Near Field Communication (NFC) Pairing



NFC Use Cases

Passive

- Bluetooth Pairing – causes a tablet, smart phone or mobile computer to automatically pair with the printer via a Bluetooth connection, within the bounds of the security profile being used. This shall contain the Bluetooth address and serial number of the printer.
- App launching – causes an app, developed either by Zebra or a third party, to be executed on a smart phone, tablet or mobile computer.
- Website launching – causes a smart phone, tablet or mobile computer to display a website developed by Zebra or a third party developer.



Note • Tapping the Zebra Print Touch icon  with a Near Field Communication (NFC) enabled smartphone will provide instant access to printer-specific information. For more information about NFC and Zebra products, go to zebra.com/nfc. Pairing Bluetooth applications via NFC is also possible. Go to zebra.com/sdk for more information.

Wearing the Printer

Swivel Belt Clip

The ZQ610 Plus and ZQ620 Plus printers have a plastic swivel belt clip included as a standard feature. To use:

1. Hook the clip over your belt.
2. Ensure the clip is securely attached to the belt.

The belt clip will pivot to allow you to move freely while wearing the printer. In order to install or remove the plastic Belt Clip you will need to remove the battery pack.



Note • ZQ6 Plus printers with an extended capacity battery do not come equipped with a belt clip.

Figure 31 • Printer with Belt Clip



Adjustable Shoulder Strap

See Figure 32 if your printer is equipped with the shoulder strap option (p/n P1031365-192).

Figure 32 • Using the Optional Shoulder Strap



1. Insert the end of the shoulder strap behind the post on the front side of the printer and loop it around the post.



2. Insert the hole on the end of the strap over the metal post (circled) to secure.



3. Repeat the steps on the opposite side of the printer.

Soft Case

The ZQ6 Plus printers have a soft case option allowing you to carry the printer from your belt. The ZQ620 Plus accessory kit is P1031365-029, and the ZQ610 Plus kit is P1031365-044.

Figure 33 • Using the Soft Case



1. Lift the top flap of the soft case which is secured with a self-fastener.



2. Slide the printer into the case such that the LCD display is visible through the plastic window.



Note • *The shoulder strap option can be used with the soft case by securing the ends of the shoulder strap on the two metal rings on the soft case.*

Hand Strap

The ZQ6 Plus hand strap accessory (p/n P1031365-027) attaches to the printer's cutouts to provide you with a convenient and secure method of carrying the printer.

Figure 34 • Using the Hand Strap



1. Insert the loop on the end of the strap through the cut out on the front of the printer as shown below.



2. Loop the end of the strap back around the cut out and secure it over the button.



3. Repeat this process for the opposite end of the strap.

Preventive Maintenance

Extending Battery Life

- Never expose the battery to direct sunlight or temperatures over 40°C (104°F) when charging.
- Always use a Zebra charger designed specifically for Lithium-Ion batteries. Any other kind of charger may damage the battery.
- Use the correct media for your printing requirements. An authorized Zebra reseller can help you determine the optimum media for your application.
- If you print the same text or graphic on every label, consider using a pre-printed label.
- Choose the correct print darkness, and print speed for your media.
- Use software handshaking (XON/XOFF) whenever possible.
- Remove the battery if the printer won't be used for a day or more and you're not performing a maintenance charge.
- Consider purchasing an extra battery.
- Remember that any rechargeable battery will lose its ability to maintain a charge over time. It can only be recharged a finite number of times before it must be replaced. Always dispose of batteries properly. Go to "Appendix F" on page 133 for more information on battery disposal.

General Cleaning Instructions



Caution • Avoid possible personal injury or damage to the printer. Never insert any pointed or sharp objects into the printer. Always turn off the printer before performing any cleaning procedures. Use care when working near the tear bars as the edges are very sharp.



Caution • The printhead can get very hot after prolonged printing. Allow it to cool off before attempting any cleaning procedures.



Important • Only use a Zebra cleaning pen (not supplied with the printer) or a cotton swab with 90% medical grade alcohol for cleaning the printhead.



Caution • Use only cleaning agents specified in the following tables. Zebra Technologies Corporation will not be responsible for damage caused by any other cleaning materials used on this printer.

ZQ6 Plus Cleaning

Area	Method	Interval
Printhead	Use a Zebra cleaning pen to swab the thin gray line on the printhead, cleaning the print elements from the center to the outside edges of the printhead.	After every five rolls of media (or more often, if needed). When using linerless type media, cleaning is required after every roll of media.
Platen Surface (Linered)	Rotate the platen roller and clean it thoroughly with a fiber-free swab, or lint free, clean, damp cloth lightly moistened with medical grade alcohol (90% pure or better) (Figure 35).	After every five rolls of media (or more often, if needed)
Platen Surface (Linerless)	Rotate platen roller and clean with a fiber-free swab and 1 part liquid soap (Palmolive or Dawn) and 25 parts water. Use pure water to clean after soap/water mixture. (Figure 36)	Clean platen only if there is an issue during printing, such as media not releasing from the platen (see the following note).
Scraper (Linerless Units Only)	Use adhesive side of media to clean scraper on linerless units. (Figure 36)	After every five rolls of media (or more often, if needed).
Tear Bar	Clean thoroughly with 90% medical grade alcohol and a cotton swab. (Figure 35)	As needed
Printer Exterior	Water-dampened cloth or 90% medical grade alcohol wipe.	As needed
Printer Interior	Gently brush out printer. Ensure the Bar Sensor and Gap Sensor windows are free of dust. (Figure 35)	As needed
Interior of units with Linerless Platens	Clean thoroughly with 90% medical grade alcohol and a fiber-free swab. (See Figure 36 for specific target areas for interior cleaning.)	After every five rolls of media (or more often, if needed).



Note • This is an emergency procedure only to remove foreign contaminants (oils, dirt) from the platen that can damage the printhead or other printer components. This procedure will shorten or even exhaust the linerless platen's useable life. If the linerless media continues to jam after cleaning and feeding 1–2 m (3–5 ft.) of media, replace the platen.

Figure 35 • ZQ6 Plus Cleaning (Linered)

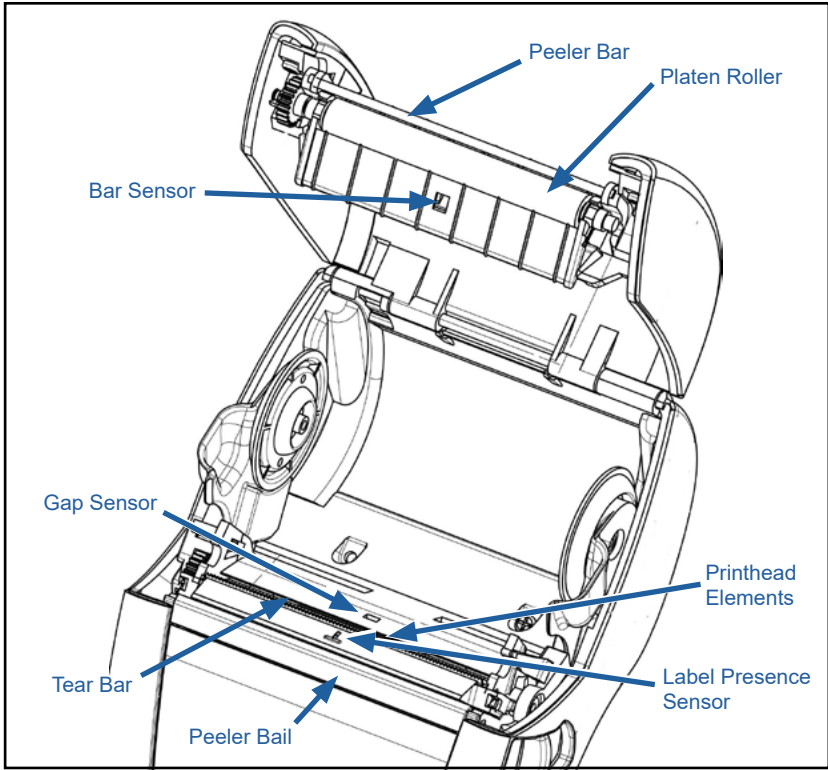
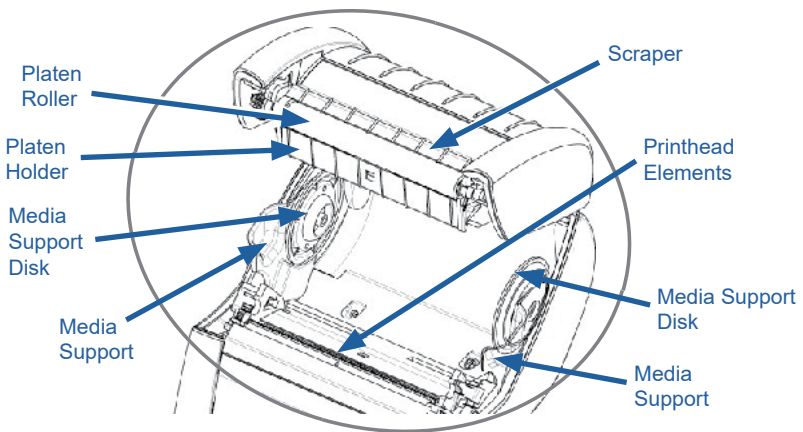

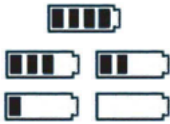
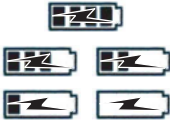







Figure 36 • ZQ6 Plus Cleaning (Linerless)



LCD Control Panel Indicators

The top of the display shows several icons which indicate the status of various printer functions. Check the indicator status, then refer to the Troubleshooting topic referenced in the following chart to resolve the problem.

Icon	Status	Indication
	Solid blue	Bluetooth link established
	Not Present	Bluetooth link inactive
	Blinking blue	Connecting or transmitting labels
	Antenna Blinking	Looking for AP
	Antenna Blinking/1 Signal Steady	WLAN Associated & Attempting Authentication
	Antenna and 2 Signals Steady	WLAN Associated and Authenticated
	Antenna and 2 Signals Blinking	Receiving Data
	Not Present	No Radio Present
	4 Green Bars	>80% charged
	3 Green Bars	60%–80% charged
	2 Yellow Bars	40%–60% charged
	1 Red Bar	20%–40% charged
	0 Bars (Red battery outline)	Low Battery
	4 green Blinking w/ Lightning Bolt	Charging >80% Capacity
	3 green Blinking w/ Lightning Bolt	Charging 60–80% Capacity
	2 yellow Blinking w/ Lightning Bolt	Charging 40–60% Capacity
	1 red Blinking w/ Lightning Bolt	Charging 20–40% Capacity
	0 Bars w/ red Lightning Bolt	Charging <20% Capacity
	Blinking red	Media cover open
	Blinking green	Receiving data
	Solid green	Ethernet Connected
	Not Present	No Ethernet Connection
	Blinking green	Data processing in progress
	Solid green	No data being processed
	Blinking red	Out of Media
	Solid white	Media present
	Blinking red	Error exists (excluding Media Out and Head Latch Open)
	Not Present	No error exists

Icon	Status	Indication
	4 green bars	802.11 signal strength > 75%
	3 green bars	802.11 signal strength <= 75%
	2 green bars	802.11 signal strength <= 50% but >25%
	1 yellow bar	802.11 signal strength <= 25%
	0 Bars	No Signal Strength

Troubleshooting Topics

1. No power:

- Check that the battery is installed properly.
- Recharge or replace the battery as necessary.



Caution • Always dispose of batteries properly. Refer to “Appendix F” on page 133 for more information on proper battery disposal.

2. Media does not feed

- Ensure that the media cover is closed and latched.
- Check the media compartment for any binding.
- Ensure the most recently printed label is removed (only in Peel mode).
- Ensure the label sensor is not blocked.

3. Poor or faded print

- Clean the print head.
- Check the quality of the media.

4. Partial or missing print

- Check the media alignment.
- Clean the printhead.
- Ensure the media cover is properly closed and latched.

5. Garbled print

- Check the baud rate.

6. No print

- Check the baud rate.
- Replace the battery.
- Check the cable to host device.
- Establish RF link and/or restore LAN associativity.
- Invalid label format or command structure. Place the printer in Communications Diagnostic (Hex Dump) mode to diagnose the problem.

7. Reduced battery charge life

- If the battery is older than 1 year, short charge life may be due to normal aging.
- Check the battery health.
- Replace the battery.

8. flashing

- Blinking green Data icon is normal while data is being received.

9. or flashing

- Check that the media is loaded and the media cover is closed and securely latched.

10. Communication error

- Check the baud rate.
- Replace the cable to the host device.

11. Label binding

- Open the head release latch and media cover.
- Remove and reinstall the media.

12. Skip Labels

- Check the media for top of form sense mark or label gap.
- Check that the maximum print field has not exceeded the label.
- Ensure the bar or gap sensor is not blocked or malfunctioning.

13. Blank LCD screen:

- Ensure the printer is turned on.
- No application is loaded or the application is corrupted: reload the program.

14. No NFC Connectivity

- Ensure the smartphone is positioned 7.62 cm (3 in.) or closer to the Print Touch icon on the side of the printer.

Troubleshooting Tests

Printing a Configuration Label

To print out a listing of the printer's current configuration follow these steps:

1. Turn the printer off. Load the media compartment with journal media (media with no black bars printed on the back).
2. Press and hold **FEED**.
3. Press and release **POWER** while keeping **FEED** pressed. When printing starts, release **FEED**.

See Figures 38 and 38a for sample configuration printouts.



Note • *The configuration report can also be printed from the Info (Help) menu on the LCD.*

Communications Diagnostics

If there is a problem transferring data between the computer and the printer, put the printer in Communications Diagnostics mode (also referred to as DUMP mode). The printer prints ASCII characters and its text representation (or a period '.', if not a printable character) from data received from the host computer.

To enter Communications Diagnostics Mode:

1. Print a configuration label as previously described.
2. At the end of the diagnostics report, the printer prints: "Press FEED key to enter DUMP Mode".
3. Press **FEED**. The printer prints: "Entering DUMP Mode".



Note • If FEED is not pressed within 3 seconds, the printer prints: “DUMP Mode not entered” and will resume normal operation.

Additionally, a file with a .dmp extension containing ASCII information is created and stored in the printer’s memory. It can be viewed, cloned, or deleted using the ZebraNet Bridge application. For more information on ZebraNet Bridge, go to zebra.com/zebranetbridge.

To terminate Communications Diagnostics mode and return the printer to normal operations:

1. Turn the printer off.
2. Wait 5 seconds.
3. Turn the printer on.

Contacting Technical Support

If the printer fails to print the configuration label, or if you encounter problems not covered in the Troubleshooting section, contact Zebra Technical Support.

You will need to supply the following information:

- Model number (for example, ZQ610 Plus or ZQ620 Plus)
- Unit serial number (Found on the large label on the back of the printer (“Appendix E”) and on the configuration label printout (Figure 37).)
- Product Configuration Code (PCC) (15 digit number found on the label on the back of the unit (“Appendix E”) and in the configuration label (Figure 37).)

Figure 37 • ZQ620 Plus Configuration Label

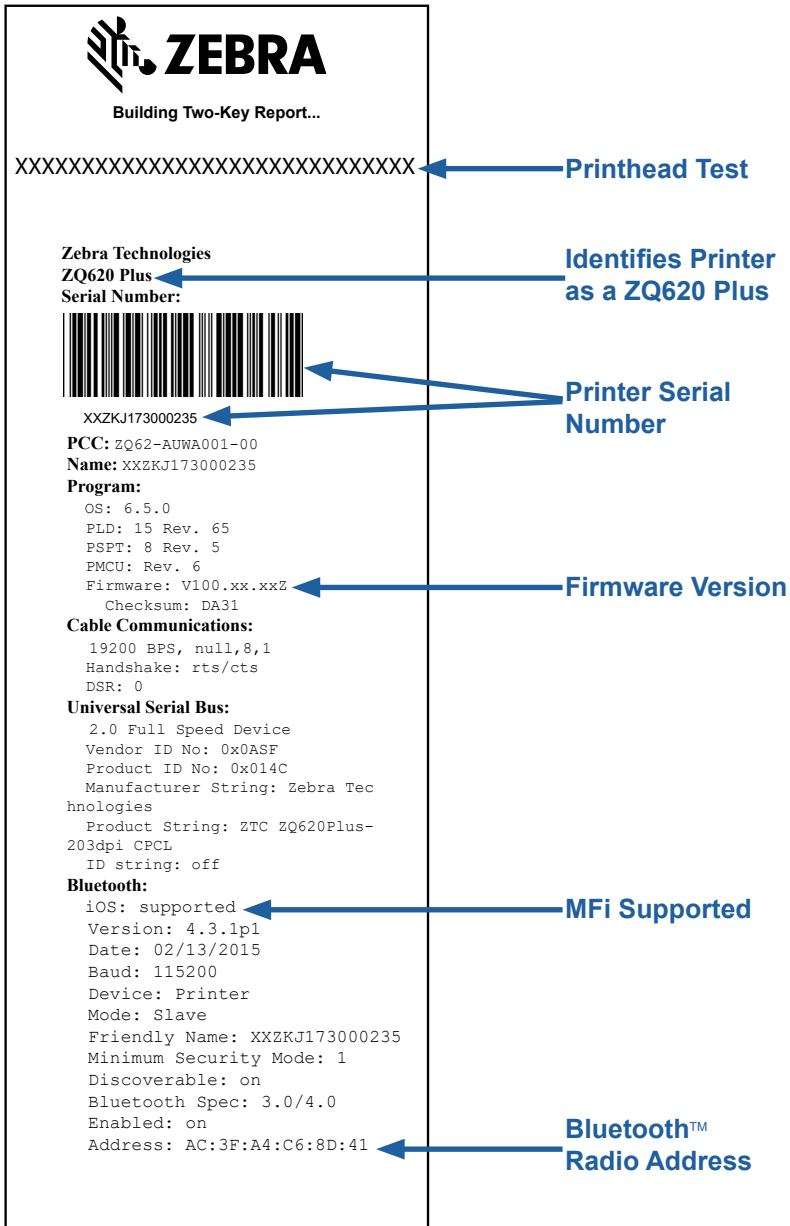

The image shows a Zebra configuration label with various fields and callouts. The Zebra logo and 'Building Two-Key Report...' are at the top. A line of 26 'X's is labeled 'Printhead Test'. The 'Zebra Technologies ZQ620 Plus Serial Number:' section includes a barcode and the serial number 'XXZKJ173000235', which is also labeled 'Printer Serial Number'. The 'Program:' section lists OS, PLD, PSPT, PMCU, and Firmware (V100.xx.xxZ) with a 'Checksum: DA31', labeled 'Firmware Version'. The 'Cable Communications:' section lists BPS, Handshake, and DSR. The 'Universal Serial Bus:' section lists device speed, vendor/product IDs, and manufacturer string. The 'Bluetooth:' section lists supported status, version, date, baud, device name, mode, friendly name, security mode, discoverability, spec, and address (AC:3F:A4:C6:8D:41), which is labeled 'Bluetooth™ Radio Address'.

ZEBRA
Building Two-Key Report...

XXXXXXXXXXXXXXXXXXXXXXXXXXXXXXXXXXXX ← **Printhead Test**

Zebra Technologies
ZQ620 Plus ← **Identifies Printer as a ZQ620 Plus**
Serial Number:

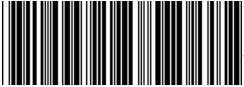

← **Printer Serial Number**

XXZKJ173000235 ← **Printer Serial Number**

PCC: ZQ62-AUWA001-00
Name: XXZKJ173000235
Program:
OS: 6.5.0
PLD: 15 Rev. 65
PSPT: 8 Rev. 5
PMCU: Rev. 6
Firmware: V100.xx.xxZ ← **Firmware Version**
Checksum: DA31

Cable Communications:
19200 BPS, null,8,1
Handshake: rts/cts
DSR: 0

Universal Serial Bus:
2.0 Full Speed Device
Vendor ID No: 0x0ASF
Product ID No: 0x014C
Manufacturer String: Zebra Technologies
Product String: ZTC ZQ620Plus-203dpi CPCL
ID string: off

Bluetooth: ← **MFi Supported**
iOS: supported
Version: 4.3.1p1
Date: 02/13/2015
Baud: 115200
Device: Printer
Mode: Slave
Friendly Name: XXZKJ173000235
Minimum Security Mode: 1
Discoverable: on
Bluetooth Spec: 3.0/4.0
Enabled: on
Address: AC:3F:A4:C6:8D:41 ← **Bluetooth™ Radio Address**

Figure 37a • ZQ620 Plus Configuration Label (cont.)



AC3FA4C68D41

Wireless:
Radio: 802.11 a/b/g/n/ac ← **802.11 ac radio option installed. This section details the radio's network settings**
Region: usa/canada
Country: usa/canada
Enabled: on
MAC Address: ac:3f:a4:c6:8d:40
IP Address: 0.0.0.0
Netmask: 255.255.255.0
Gateway: 0.0.0.0
Operating Mode: infrastructure
International Mode: off
Preamble Length: long
Security: none
Stored ESSID: 125
Associated: no
DHCP: on
DHCP CID type: 1
DHCP CID: ac3fa4c68d40
Power Save: on

Ethernet:
MAC Address: 00:07:4d:7a:7b:26
IP Address: 0.0.0.0 ← **Ethernet Information**
Netmask: 255.255.255.0
Gateway: 0.0.0.0
DHCP: on
DHCP CID type: 1
DHCP CID: 00074d7a7b26

Active Network Information:
Active Network: Unknown
IP Address: 0.0.0.0 ← **Network Information**
Netmask: 255.255.255.0
Gateway: 0.0.0.0
TCP Port: 6101
Alternate TCP Port: 9100
TCP JSON Config Port: 9200
UDP Port: 6101
Remote Server:
Remote Server Port: 10013
TCP: on
UDP: on
LPD: on
DHCP: on
BOOTP: on
FTP: on
HTTP: on
SMTP: on
POP3: on
SNMP: on
TELNET: on
MIRROR: off
UDP Discovery: on
Weblink:
DHCP CID type: 1
DHCP CID: ac3fa4c68d40

Peripherals:
LCD: Installed ← **Peripherals Installed**

```

Power Management:
In-activity Timeout:36000 Secs
Low-battery Timeout:60 Secs
Remote (DTR) pwr-off:Disabled
Voltage      :8.54
Low-bat Warning  :6.93(176)
Low-bat Shut-down :6.53(166)
Power On Cycles  :23
Battery Health   :good
Battery Cycle Count:NA

Memory:
Flash :134217728 Bytes
RAM   :8388608 Bytes

Label:
Width :576 dots, 72 mm
Height:65535 dots, 8191 mm

Sensors: (Adj)
Pres[DAC:128,Thr:60,Cur:0]
Label Removed
Media [91 (576 dots)]
Black Bar [DAC:136,Thr:70,Cur:0
]
Gap [DAC:130,Thr:50,Cur:96]
Temperature :27C (62)
Voltage     :8.0V (255)

Resident Fonts:
Font      Sizes  Chars
-----
0         0- 6   20-FF
1         0     20-80
2         0- 1   20-59
4         0- 7   20-FF
5         0- 3   20-FF
6         0     20-44
7         0- 1   20-FF

File Directory:
File      Size
-----
E:2KEY.TXT      3507
E:TT0003M_.TTF 169188
134044672 Bytes Free

Command Language:
CCL Key '[' [21]

ZPL Configuration Information:
Rewind.....Print Mode
Mark.....Media Type
30.0.....Darkness
+00.....Tear Off Adjust
2030.....Label Length
72mm.....Print Width
7Eh.....Control Prefix
2Ch.....Delimiter
00.....Top Position
No Motion..Media Power Up
Feed....Media Head Closed
00.....Left Margin
576.....Dots per row
End ZPL Configuration
Print-head test: OK
End of report

Press FEED key to enter DUMP mode

```

**Flash and RAM
Memory Installed**

**Maximum Label
Size**

**Resident Human
Readable Fonts
Installed**

**Files loaded in
printer memory
(includes pre-scaled
or scalable fonts)**

**CPCL and ZPL
programming
languages are
supported**

Specifications



Note • Printer specifications are subject to change without notice.

Printing Specifications

Parameter	ZQ620 Plus	ZQ610 Plus
Print Width	Up to 72 mm (2.91 in.)	Up to 48 mm (1.89 in.)
Print Speed	101.6 mm (4 in.)/sec	Same
	127 mm (5 in.)/sec in Draft mode	
Printhead Burn Line to Tear Edge Distance	5.08 mm (0.20 in.)	4.31 mm (0.17 in.)
Printhead Life	600K in. of paper feed MTBF when using Zebra media	Same
Print Density	203 dots/in. or better	Same

Memory and Communications Specifications

Parameter	ZQ6 Plus Printers
Flash Memory	512 MB ¹
RAM Memory	256 MB ¹
Standard Communications	RS-232 serial port (14 Pin serial connector) Configurable Baud rate (from 9600 to 115.2 Kbps), parity and data bits Software (X-ON/X-OFF) or hardware (DTR/STR) communication handshake protocols
	USB 2.0 Full Speed Interface (12 Mbps)
Wireless Communication Options	1. Dual Radio: 802.11ac with Bluetooth v4.1 (both Classic & BLE) 2. Bluetooth v4.1 (both Classic & BLE)
Real Time Clock (RTC)	Time and date under application control. Refer to ZPL Programming Manual, available at zebra.com/manuals for RTC commands.
Ethernet	10 or 100 mbps Ethernet auto detect when docked in cradle.

1. Retrieve the printer memory configuration by printing a configuration label (go to page 92).

Label Specifications

Parameter	ZQ620 Plus	ZQ610 Plus
Max Media Width	25.4–79.4 mm (1.0–3.125 in.)	25.4–55.37 mm (1.0–2.18 in.)
Max/Min Label Length	12.7 – 812.8 mm (0.5–32 in.) max	Same
Black Bar Sensor to Printhead Burnline Distance	15.87 mm (0.62 in.) +/- 0.635 mm (0.025 in.)	13.46 mm (0.53 in.)
Media Thickness (except Tag)	0.05842–0.1651 mm (2.3–6.5 mils)	Same
Max Tag Thickness	0.05842–0.1397 mm (2.3–5.5 mils)	Same
Max Label Roll Outer Diameter	66.8 mm (2.6 in.)	55.8 mm (2.2 in.)
Inner Core Diameters**	19 mm (0.75 in.) or 35.05 mm (1.38 in.)	Same
Black Mark Location	The reflective media black marks should be centered on media roll	Same
Black Mark Dimensions	Minimum mark width: 12.7 mm (0.5 in.) perpendicular to inside edge of media, centered within the width of the roll. Mark length: 3–11 mm (0.12–0.43 in.) parallel to inside edge of media.)	Same



Note • Use Zebra brand direct thermal media that is outside wound. Media may be reflective (black mark) sensing, or transmissive (gap) sensing, die-cut, continuous or linerless. For die-cut labels, use only full auto dies.

**** ZQ6 Plus printers support coreless media which is 19 mm (0.75 in.) in inner diameter.**

CPCL Font and Bar Code Specifications and Commands

Standard Fonts	25 bit-mapped fonts; 1 scalable font (CG Trimvirate Bold Condensed*)	
Available Optional Fonts	Optional International character sets: Chinese 16 x 16 (trad), 16 x 16 (simplified), 24 x 24 (simplified); Japanese 16 x 16, 24 x 24	
Linear Bar Codes Available	Barcode (CPCL Command)	
	Aztec (AZTEC) Codabar (CODABAR, CODABAR 16) UCC/EAN 128 (UCCEAN128) Code 39 (39, 39C, F39, F39C) Code 93 (93) Code 128 (128) EAN 8, 13, 2 and 5 digit extensions (EAN8, EAN82, EAN85, EAN13, EAN132, and EAN135) EAN-8 Composite (EAN8) EAN-13 Composite (EAN13) Plessey (PLESSEY) Interleaved 2 of 5 (I2OF5) MSI (MSI, MSI10, MSI1110) FIM/POSTNET (FIM) TLC39 (TLC39) UCC Composite A/B/C (128(Auto)) UPCA, 2 and 5 digit extensions (UPCA2 and UPCA5) UPCA Composite (UPCA) UPCE, 2 and 5 digit extensions (UPCE2 and UPCE5) UPCE Composite (UPCE) MaxiCode (MAXICODE) PDF 417 (PDF-417) Datamatrix (using ZPL emulation) (DATAMATRIX) QR Code (QR)	
2-D Bar Codes Available	RSS:	RSS-14 (RSS-Subtype 1) RSS-14 Truncated (RSS-Subtype 2) RSS-14 Stacked (RSS-Subtype 3) RSS-14 Stacked Omnidirectional (RSS-Subtype 4) RSS Limited (RSS-Subtype 5) RSS Expanded (RSS-Subtype 6)
Rotation Angles	0°, 90°, 180°, and 270°	

****Contains UFST from Agfa Monotype Corporation Downloadable optional bit-mapped and scalable fonts via ZebraNet Bridge software.***

ZPL Font and Bar Code Specifications and Commands

Standard Fonts	15 bit-mapped fonts; 1 scalable font (CG Trimvirate Bold Condensed*)
Available Optional Fonts	Zebra offers font kits covering multiple languages including Simplified and Traditional Chinese, Japanese, Korean, Hebrew/Arabic, and others.
Linear Bar Codes Available 2-D Bar Codes Available	Barcode (CPCL Command)
	Aztec (^B0) Codabar (^BK) Codablock (^BB) Code 11 (^B1) Code 39 (^B3) Code 49 (^B4) Code 93 (^BA) Code 128 (^BC) DataMatrix (^BX) EAN-8 (^B8) EAN-13 (^BE) GS1 DataBar Omnidirectional (^BR) Industrial 2 of 5 (^BI) Interleaved 2 of 5 (^B2) ISBT-128 (^BC) LOGMARS (^BL) Micro-PDF417 (^BF) MSI (^BM) PDF-417 (^B7) Planet Code (^B5) Plessey (^BP) Postnet (^BZ) Standard 2 of 5 (^BJ) TLC39 (^BT) UPC/EAN extensions (^BS) UPC-A (^BU) UPC-E (^B9) Maxi Code (^BD) QR Code (^BQ)
Rotation Angles	0°, 90°, 180°, and 270°

****Downloadable optional bit-mapped & scalable fonts via ZebraNet Bridge software.***

Communication Ports

RS-232C

Pin #	Signal Name	Type	Description
1	CTS	input	Clear To Send from host
2	TXD	output	Transmit Data
3	RXD	input	Receive Data
4	DSR	input	Data Set Ready: low to high transition turns printer on, high to low transition turns printer off (if enabled)
5	GND		Ground
6	DTR	output	Data Terminal Ready: set high when printer is on. Switched 5V (300mA max)
7	N/A		Do Not Use
8	RTS	output	Request To Send set high when printer is ready to accept a command or data
9	N/A		Do Not Use
10	N/A		Do Not Use
11	N/A		Do Not Use
12	N/A		Do Not Use
13	N/A		Do Not Use
14	N/A		Do Not Use

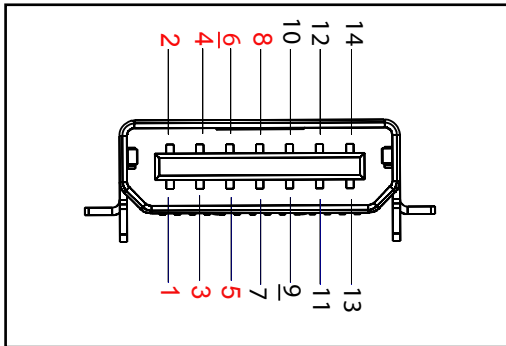

Figure 38 • RS-232C Communication Port

USB

Pin #	Signal Name	Type	Description
1	VBUS	-	USB Bus Power
2	USB-	bi-directional	I/O signals
3	USB+	bi-directional	I/O signals
4	USB_ID	-	Identifies A/B connector
5	Return		Ground

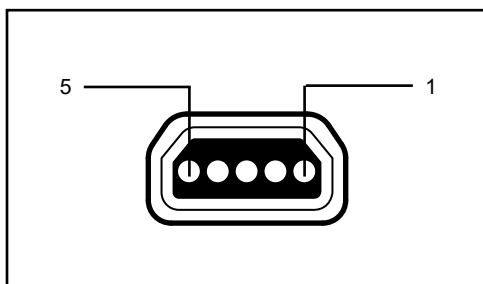

Figure 39 • USB Communication Port

Physical, Environmental and Electrical Specifications

Parameter	ZQ620 Plus	ZQ610 Plus
Weight w/ battery	1.6 lbs (0.75 kg)	1.35 lbs. (0.61 kg)
Temperature	Operating: -20–50°C (-4–122°F) Healthcare is 0–50°C (32–122°F)	Operating: -20–50 °C (-4–122°F) Healthcare is 0–50°C (32–122°F)
	Storage: -25–65°C (-13–149°F)	Same
	Charging: 0–40°C (32–104°F)	Same
Relative Humidity	Operating/Storage: 10–90% non-condensing	Same
Battery	Smart Battery (2- or 4-cell) Lithium-Ion, 7.4 VDC (nominal); 2.45 Ahr min.	Same
	4-cell Extended Smart Battery (Optional)	4-cell Extended Smart Battery (Optional)
Intrusion Protection (IP) Rating	IP43 (without optional environmental case) IP54 (with case)	IP43 (without optional environmental case) IP54 (with case)

Figure 40 • ZQ620 Plus Dimensions



Figure 41 • ZQ620 Plus Mounting Hole Dimensions

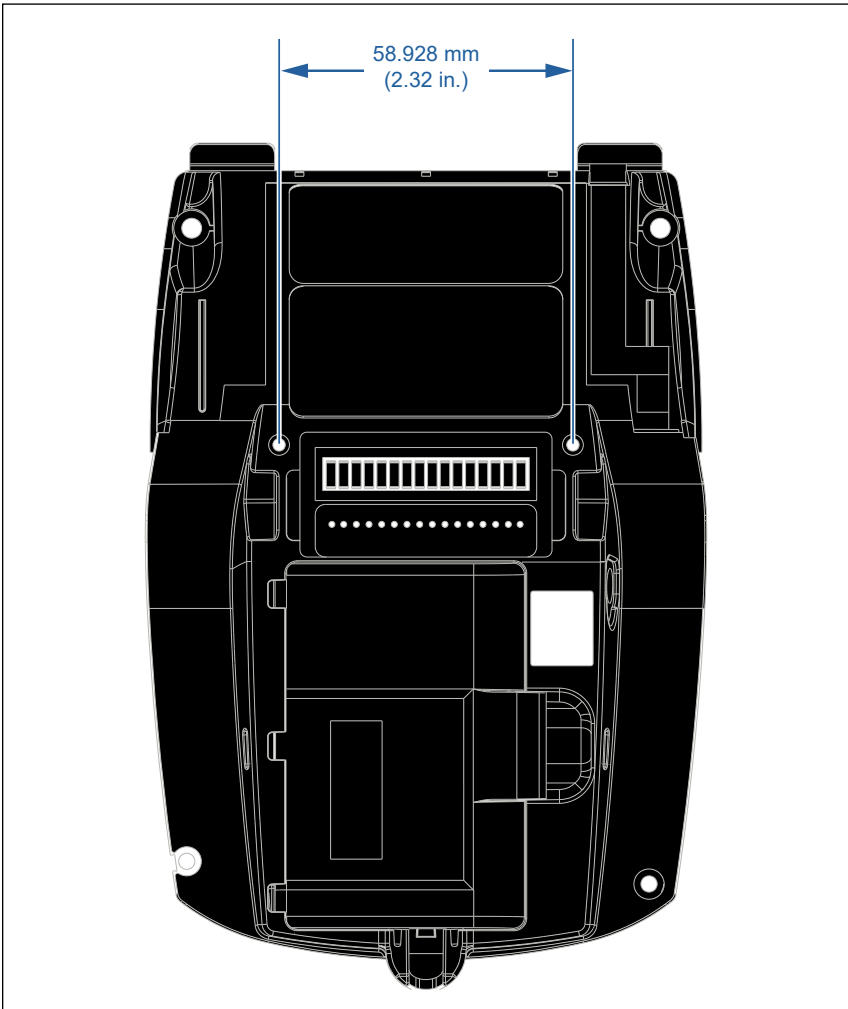

Use two M2.5 x 0.45 screws in the indicated positions above.

Figure 42 • ZQ610 Plus Dimensions



Figure 43 • ZQ610 Plus Mounting Hole Dimensions

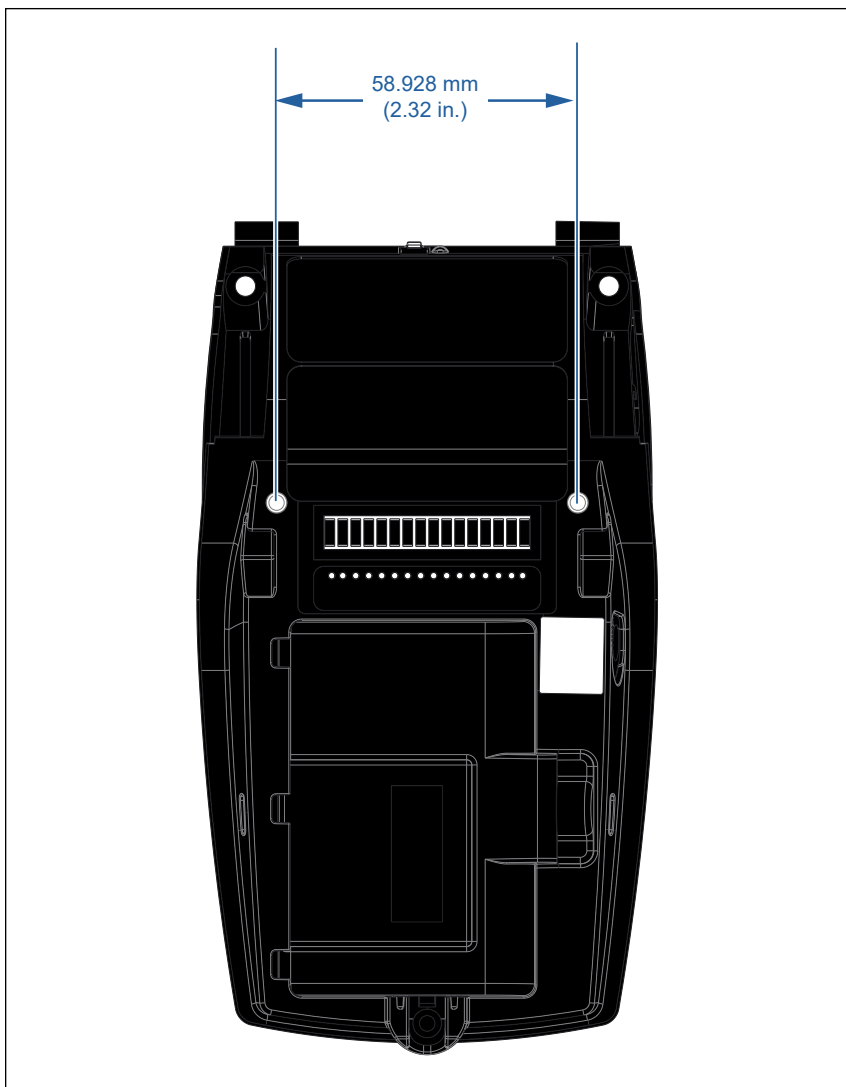

Use two M2.5 x 0.45 screws in the indicated positions above.

ZQ6 Plus Accessories

Part #	Description
P1031365-006	KIT ACC QL _n 220 RUBBER DOOR I/O (15)
P1031365-018	KIT ACC QL _n 320 RUBBER DOOR I/O (15)
P1031365-019	KIT ACC QL _n 220/QL _n 320 RUBBER DOOR DC JACK (15)
P1031365-022	KIT ACC QL _n 220/320 PLATEN GEAR 48P 22T (25)
P1031365-024	KIT ACC MOBILE AC ADAPTER US (type A) cord
P1031365-027	KIT ACC QL _n HAND STRAP
P1031365-028	KIT ACC QL _n BELT CLIP REPLACEMENT (20)
P1031365-029	KIT ACC QL _n 320 SOFT CASE (Includes Shoulder Strap)
P1031365-033	KIT ACC QL _n -EC AC ADAPTER US (type A) CORD (refer to Sales for other countries)
P1031365-038	KIT ACC QL _n -EC
P1031365-044	KIT ACC QL _n 220 SOFT CASE (Includes Shoulder Strap)
P1031365-045	KIT ACC QL _n -EC4 AC ADAPTER US CORD (refer to Sales for other countries)
P1031365-050	KIT ACC EC4 WALL MOUNT
P1031365-052	KIT ACC QL _n SERIAL CABLE (with strain relief) QL ADAPTER (female DIN)
P1031365-053	KIT ACC QL _n SERIAL CABLE, 6' (with strain relief) PC-DB9
P1031365-054	KIT ACC QL _n SERIAL CABLE (with strain relief) to MC9000
P1031365-055	KIT ACC QL _n PC-USB CABLE, 6' (with strain relief)
P1031365-056	KIT ACC QL _n SERIAL CABLE (with strain relief) RJ45 to TELZON ADAPTER
P1031365-057	KIT ACC QL _n SERIAL CABLE (with strain relief) to LS2208 Scanner
P1031365-058	KIT ACC QL _n 16 PIN SERIAL CABLE (with strain relief) to MC3000
P1031365-059	KIT ACC QL _n 220/QL _n 320 SPARE BATTERY SMART
P1031365-060	KIT ACC QL _n 11 PIN SERIAL CABLE (with strain relief) to MC3000
P1031365-061	KIT ACC QL _n SERIAL DEX CABLE (with strain relief)
P1031365-062	KIT ACC QL _n SERIAL CABLE (with strain relief) to RJ45
P1031365-063	KIT ACC SC2 Li-ION SMART CHARGER, US (type A) CORD (refer to Sales for other countries)
P1031365-069	KIT, ACC QL _n 220/320 and ZQ500 SERIES SPARE EXTENDED BATTERY with LED's
P1031365-192	KIT ACC QL _n SERIES SHOULDER STRAP

ZQ6 Plus Accessories cont.

P1031365-104	KIT ACC QL _n SERIAL CABLE (with strain relief) to LS2208 SCANNER EXTENDED
P1024458-002	BELT,CLIP,QL _n ,HC
AC18177-5	MODEL UCLI72-4 QUAD BATTERY CHARGER (US line cord, refer to Sales for others)
BTRY-MPP-34MA1-01	3400 mAh BATTERY for ZQ6 and ZQ500 SERIES
BTRY-MPP-34MAHC1-01	3400 mAh BATTERY for ZQ6 HEALTHCARE PRINTER
SAC-MPP-3BCHGUS1-01	3-SLOT BATTERY CHARGER
SAC-MPP-6BCHUS1-01	DUAL 3-SLOT BATTERY CHARGER
SAC-MPP-1BCHGUS1-01	1-SLOT BATTERY CHARGER
VAM-MPP-VHCH1-01	VEHICLE ADAPTER
P1065668-008	KIT,ACC,QL _n ,AC ADAPTER,STRAIGHT,30W,HC with US (type A) CORD



Note • Go to “Appendix A” on page 109 for additional information on Data I/O cables.

Interface Cables (RS-232 Cables)

Part Number P1031365-053; DB-9 to 14-Pin Serial

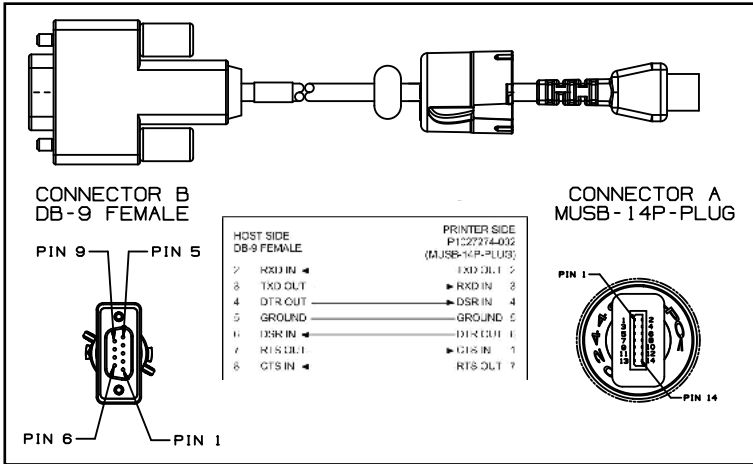

Part Number P1031365-052; 8-Pin DIN to 14-Pin Serial Cable

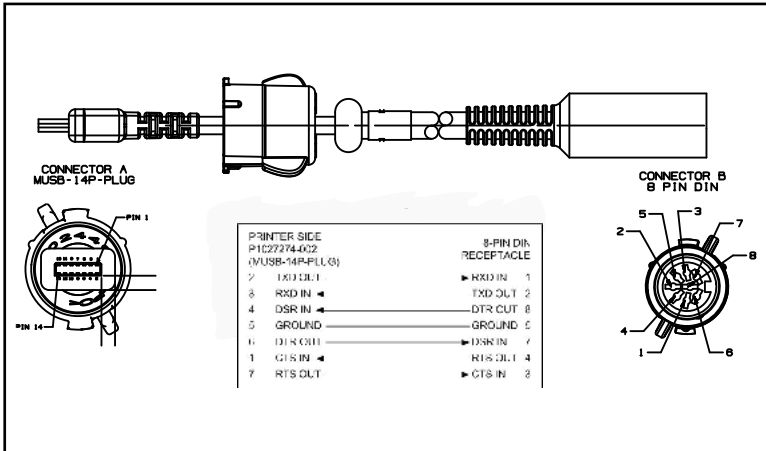

USB Cables

Part Number AT17010-1; USB A to USB Mini B Cable

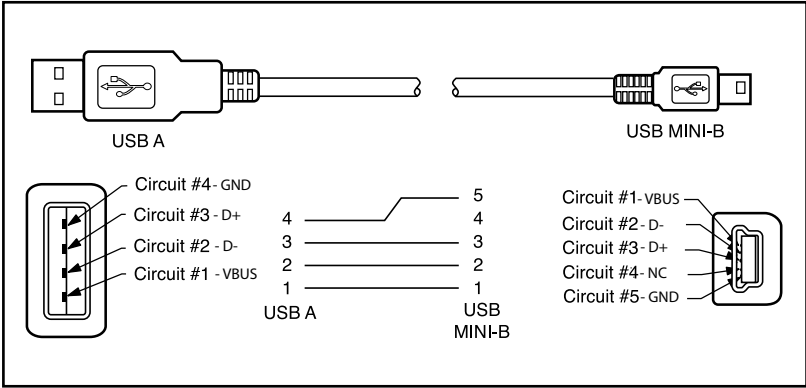

Part Number P1031365-055; 4 Position USB Mini to 4-Pin USB (w/ Strain Relief)

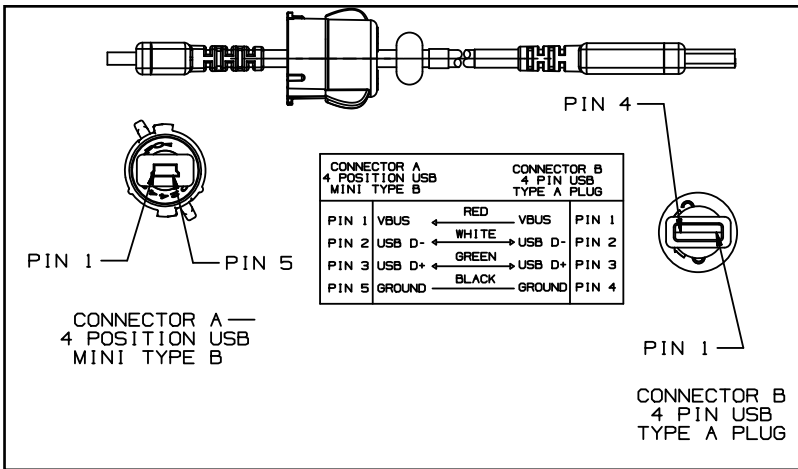

Note • For a listing of interface cables, go to zebra.com/accessories.

Appendix B

Media Supplies

To ensure maximum printer life, performance, and consistent print quality, it is recommended that only media produced by Zebra be used. The advantages include:

- Consistent quality and reliability of media products
- Large range of stocked and standard formats
- In-house custom format design service
- Large production capacity which services the needs of many large and small media consumers including major retail chains worldwide
- Media products that meet or exceed industry standards

For more information go zebra.com/supplies.

Appendix C

Maintenance Supplies

In addition to using quality media provided by Zebra, it is recommended that the printer be cleaned as prescribed in the maintenance section. The following item is available for this purpose:

- Cleaning Pen (12 pack): p/n 105950-035



SETTINGS Menu

DARKNESS -49
⬆

Set the darkness to the lowest setting that provides good print quality. If you set darkness too high, the label image may print unclearly, bar codes may not scan correctly, or the printhead may wear prematurely.

SGD: [print.tone_zpl](#)

PRINT SPEED 4.0
⬆

Select the speed for printing a label (given in inches per second). Slower print speeds typically yield better print quality.

SGD: [media.speed](#)

MEDIA TYPE MARK
⬆

Select the type of media that you are using.

SGD: [ezpl.media_type](#)

TEAR OFF 0
⬆

If necessary, adjust the position of the media over the tear-off bar after printing.

SGD: [ezpl.tear_off](#)

PRINT WIDTH 576
⬆

Specify the width of the labels used. The default value is the maximum width for the printer based on the printhead's DPI value.

SGD: [ezpl.print_width](#)

PRINT MODE REWIND
⬆

Select a print mode that is compatible with your printer options.

SGD: [ezpl.print_mode](#)

LABEL TOP 0
⬆

If necessary, shift the position of the image vertically on the label. Negative numbers move the image higher on the label (toward the printhead). Positive numbers move the image farther down on the label (away from the printhead) by the specified number of dots.

SGD: [zpl.label_top](#)

LEFT POSITION 0
⬆

If necessary, shift the print position horizontally on the label. Positive numbers move the left edge of the image toward the center of the label by the number of dots selected, while negative numbers move the left edge of the image toward the left edge of the label.

SGD: [zpl.left_position](#)

REPRINT MODE OFF
⬆

When Reprint mode is enabled, you can reprint the last label printed either by issuing certain commands or by pressing the DOWN ARROW on the keypad.

SGD: [ezpl.reprint_mode](#)

LABEL LENGTH MAX 39

Set the maximum label length to a value that is at least 25.4 mm (1.0 in.) greater than the actual label length plus the interlabel gap. If you set the value smaller than the label length, the printer assumes continuous media is loaded, and the printer cannot calibrate.

SGD: [ezpl.label_length_max](#)

LANGUAGE ENGLISH

If necessary, change the language that the printer displays.

SGD: [display.language](#)



Note • The language selected displays in the same language making it easier to find one you can read.



TOOLS Menu

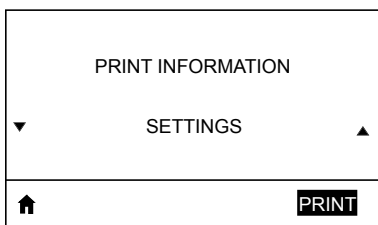

Prints a printer configuration label, sensor profile, barcode information, font information, images, formats, two-key report, and network settings.

SGD: [device.user_vars.display_wmlsg_printlist](#)

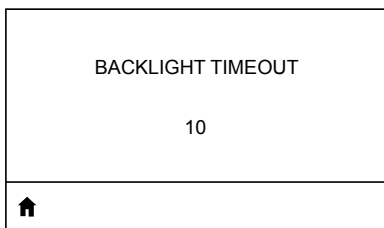

Sets the duration of the LCD backlight in seconds.

SGD: [display.backlight_on_time](#)

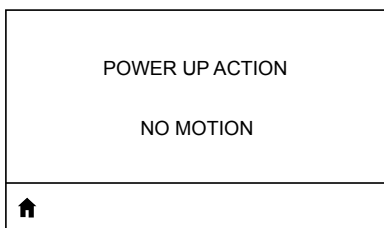

Set the action for the printer to take during the power-up sequence, such as no motion and calibrate.

SGD: [ezpl.power_up_action](#)

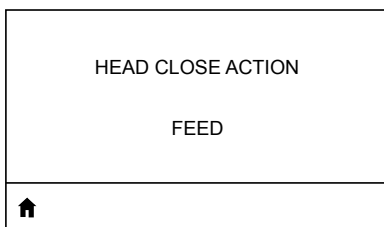

Set the action for the printer to take when you close the printhead, such as feed and calibrate.

SGD: [ezpl.head_close_action](#)

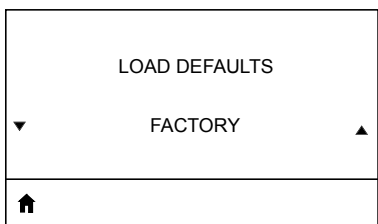

Restore specific printer, print server, and network settings back to the factory defaults. Use care when loading defaults because you will need to reload all settings that you changed manually. This menu item is available through two user menus with different default values for each.

SGD: [ezpl.load_defaults](#)

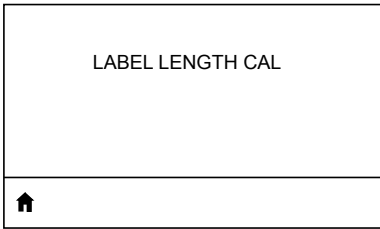

Calibrate the printer to adjust the length of the label.

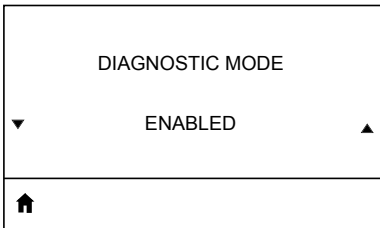

Use this diagnostic tool to cause the printer to output the hexadecimal values for all data received by the printer.

SGD: [device.user_vars.display_diagnostic_list](#)

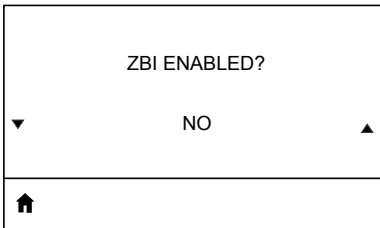

This menu item indicates if the Zebra Basic Interpreter (ZBI 2.0TM.) option is enabled on your printer.

SGD: [zbi.key](#)

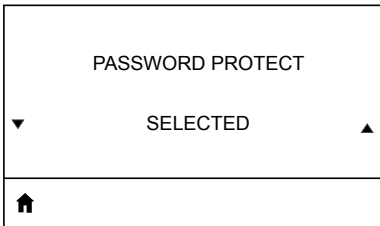

Select the level of password protection for user menu items. The default printer password is 1234.

SGD: [display.password.level](#)

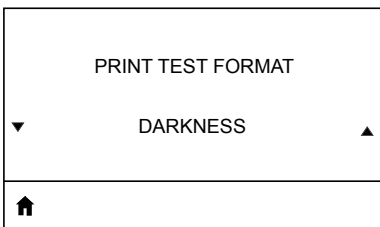

Performs a print test in progressively darker patterns.



NETWORK Menu

ACTIVE PRINT SERVER NONE

Informs you of the presence of an active server. Only one print server can be installed at a time, therefore the print server installed is the active print server.

SGD: [ip.active_network](#)

PRIMARY NETWORK WIRELESS

View or modify whether the wireless print server is considered primary. You may select which one is primary.

SGD: [ip.primary_network](#)

WLAN IP ADDRESS 0.0.0.0

View, and if necessary, change the printer's WLAN IP address.

SGD: [wlan.ip.addr](#)

WLAN SUBNET MASK 255.255.255.0

View, and if necessary, change the WLAN subnet mask.

SGD: [wlan.ip.netmask](#)

WLAN GATEWAY 0.0.0.0

View, and if necessary, change the default WLAN gateway.

SGD: [wlan.ip.gateway](#)

WLAN IP PROTOCOL ALL



This parameter tells if you or the server selects the WLAN IP address.

SGD: [wlan.ip.protocol](#)

WLAN MAC ADDRESS 00:19:70:7A:20:44



View the WLAN Media Access Control (MAC) address of the wireless print server that is installed in the printer.

SGD: [wlan.mac_addr](#)

ESSID DSF802LESS54



The Extended Service Set Identification (ESSID) is an identifier for your wireless network. This setting, which cannot be modified from the control panel, gives the ESSID for the current wireless configuration.

SGD: [wlan.essid](#)

AP MAC ADDRESS 00:05:9A:3C:78:00



View the AP MAC address associated with the printer.

SGD: [wlan.bssid](#)

CHANNEL



View the wireless channel being used when the wireless network is active and authenticated.

SGD: [wlan.channel](#)

SIGNAL 0



View the wireless signal strength when the wireless network is active and authenticated.

SGD: [wlan.signal_strength](#)

WIRED IP ADDRESS 0.0.0.0



View, and if necessary, change the printer's wired IP address.

SGD: [internal_wired.ip.addr](#)

WIRED SUBNET MASK 255.255.255.0



View, and if necessary, change the printer's wired subnet mask.

SGD: [internal_wired.ip.netmask](#)

WIRED GATEWAY 0.0.0.0



View, and if necessary, change the wired gateway setting.

SGD: [internal_wired.ip.gateway](#)

WIRED IP PROTOCOL ALL



This parameter tells if you (permanent) or the server (dynamic) selects the IP address. If a dynamic option is chosen, this parameter tells the method(s) by which the wired or wireless server receives the IP address from the server.

SGD: [internal_wired.ip.protocol](#)

WIRED MAC ADDRESS 00:07:4D:3F:D3:B2



View, and if necessary, change the printer's network signal.

SGD: [internal_wired.mac_addr](#)

IP PORT 6101



This printer setting refers to the internal wired print servers port number that the TCP print service is listening on. Normal TCP communications from the host should be directed to this port.

SGD: [ip.port](#)

IP ALTERNATE PORT 9100



This command sets the port number of the alternate TCP port.

SGD: [ip.port_alternate](#)

PRINT INFORMATION ▼ NETWORK ▲

Print the specified information on one or more labels. This menu item is available through three user menus with different default values for each.

SGD: [device.user_vars.display_wmlsgd_printlist](#)

RESET NETWORK ▼ ▲

This option resets the wired or wireless print server and saves any changes that you made to any network settings.

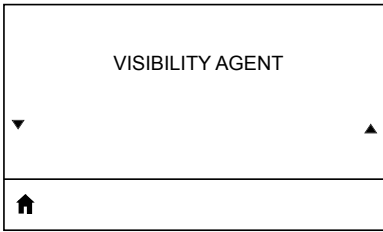

When the printer is connected to a wired or wireless network, it will attempt to connect to Zebra's Asset Visibility Service via the Cloud-based Zebra Printer Connector using an encrypted, certificate-authenticated web socket connection. The printer sends Discovery Data and Settings and Alerts Data. Data printed via any label formats is NOT transmitted. To opt out of this feature, disable this setting.

SGD: [weblink.zebra_connector.enable](#)

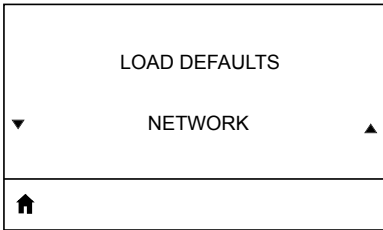

Restore specific printer, print server, and network settings back to the factory defaults. Use care when loading defaults because you will need to reload all settings that you changed manually. This menu item is available through two user menus with different default values for each.

SGD: [ezpl.load_defaults](#)



BATTERY Menu



Indicates the current health of the battery, such as Good and Past Useful Life.

SGD: [power.health](#)

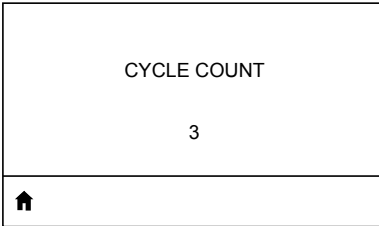

View the current charging cycle count of the battery.

SGD: [power.cycle_count](#)

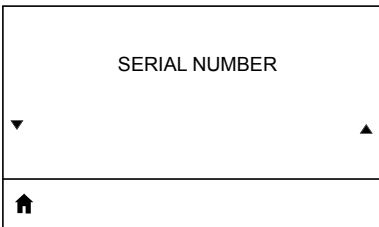

Indicates the serial number of the battery pack.

SGD: [power.serial_number_string](#)

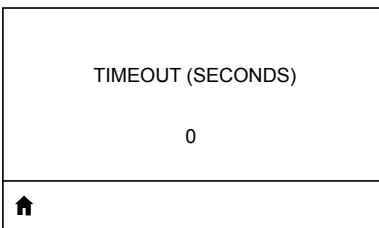

View, and if necessary, change the battery timeout.

SGD: [power.inactivity_timeout_alt](#)

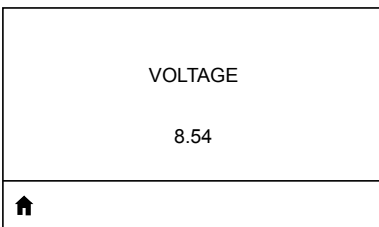

View the current voltage level of the battery pack.

SGD: [power.voltage](#)

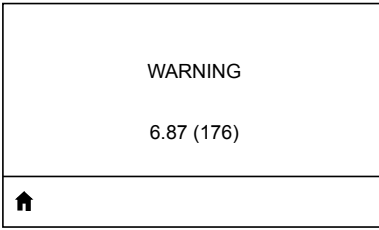

SGD: [power.low_battery_warning](#)

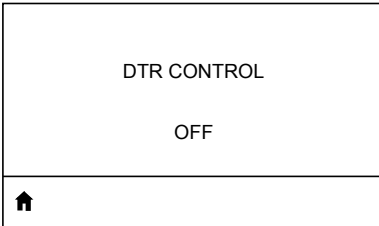

SGD: [power.dtr_power_off](#)

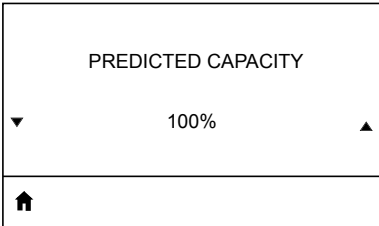

SGD: [power.relative_state_of_charge](#)

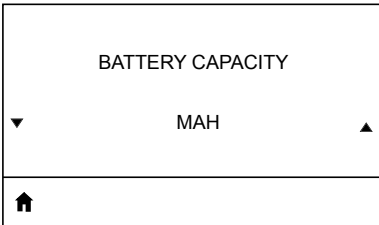

Battery capacity measured in mA.H.

SGD: [power.remaining_capacity](#)

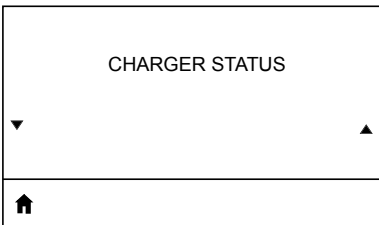

Indicates the presence of a battery charger.

SGD: [power.chrgr_status](#)

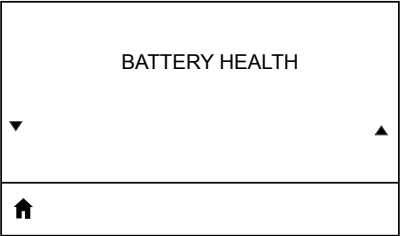

SGD: power.percent_health



LANGUAGES Menu

LANGUAGE	
▼	ENGLISH ▲
↑	

If necessary, change the language that the printer displays.

SGD: [display.language](#)



Note • The language selected displays in the same language making it easier to find one you can read.

COMMAND LANGUAGE	
▼	HYBRID_XML_ZPL ▲
↑	

View or select the appropriate command language.

SGD: [device.languages](#)

COMMAND CHAR	
^ (5E)	
↑	

The format command prefix is a two-digit hex value used as a parameter place marker in ZPL/ZPL II format instructions. The printer looks for this hex character to indicate the start of a ZPL/ZPL II format instruction. Set the format command character to match what is used in your label formats.

SGD: [zpl.format_prefix](#)

CONTROL CHAR	
~ (7E)	
↑	

Set the control prefix character to match what is used in your label formats.

SGD: [zpl.command_prefix](#)

DELIMITER CHAR	
, (2E)	
↑	

The delimiter character is a two-digit hex value used as a parameter place marker in ZPL/ZPL II format instructions. Set the delimiter character to match what is used in your label formats.

SGD: [zpl.delimiter](#)

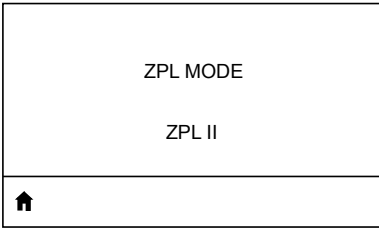

Select the mode that matches what is used in your label formats. This printer accepts label formats written in either ZPL or ZPL II, eliminating the need to rewrite any ZPL formats that already exist. The printer remains in the selected mode until it is changed in one of the ways listed here.

SGD: [zpl.zpl_mode](#)

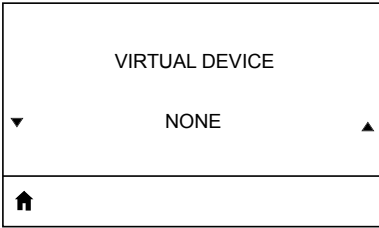

If any Virtual Device apps are installed on your printer, you may view or enable/disable them from this user menu. For more information about Virtual Devices, go to the User Guide for the appropriate Virtual Device, or contact your local reseller.

SGD: [apl.selector](#)



SENSORS Menu

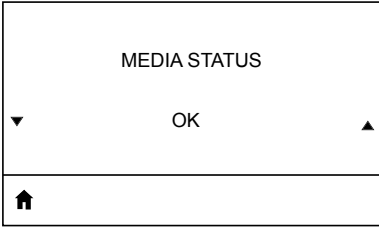

Informs you of the presence or absence of media in the printer.

SGD: [media.status](#)

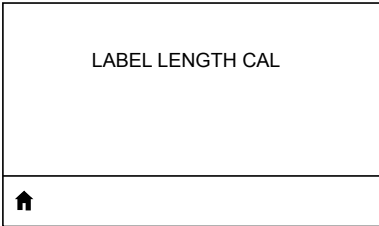

SGD: [zpl.calibrate](#)

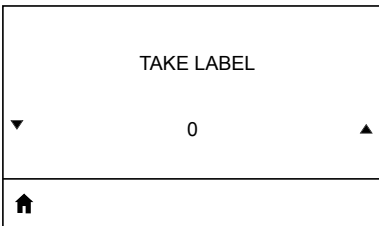

Set the intensity of the take label LED.

SGD: [ezpl.take_label](#)



Note • This value is set during sensor calibration. Do not change this setting unless you are told to do so by Zebra Technical Support or by an authorized service technician.



PORTS Menu

BAUD RATE 19200
⬆

Select the baud value that matches the one being used by the host computer.

DATA BITS 8
⬆

Select the data bits value that matches the one being used by the host computer.

PARITY NONE
⬆

Select the parity value that matches the one being used by the host computer.

STOP BITS 1
⬆

Select the stop bits value that matches the one being used by the host computer.

HOST HANDSHAKE RTS/CTS
⬆

Select the handshake protocol that matches the one being used by the host computer.

HALT ON ERROR	
▼	YES ▲
🏠	

Select YES or NO to halt printing upon the occurrence of an error.



BLUETOOTH Menu

BLUETOOTH ADDRESS NO BLUETOOTH RADIO
🏠

View the Bluetooth address for the presence of a BT radio.

SGD: [bluetooth.address](#)

MODE PERIPHERAL
🏠

View the Bluetooth connection pair printer's device type—Peripheral will always be displayed.

DISCOVERY ON
🏠

Select if the printer is “Discoverable” for Bluetooth device pairing. View the discovery status, i.e. ON or OFF.

SGD: [bluetooth.discoverable](#)

CONNECTED NO
🏠

View the connection status of the BT radio, such as YES or NO.

SGD: [bluetooth.connected](#)

BT SPEC VERSION NO RADIO
🏠

View the Bluetooth spec version.

SGD: [bluetooth.radio_version](#)

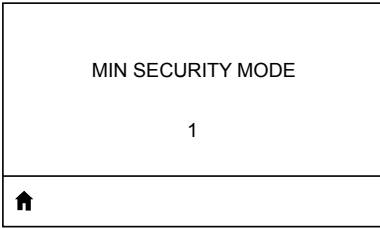

View, and change if necessary, the minimum security mode of the BT radio.

SGD: [bluetooth.minimum_security_mode](#)

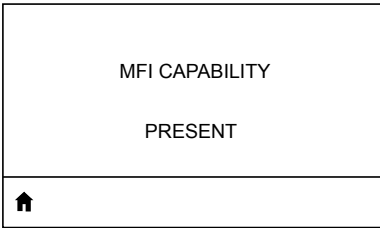

Informs you of the presence or availability of Made for iPhone (MFi) capability.

SGD: [device.feature.mfi](#)

Appendix E

Serial and PCC Number Locations for ZQ6 Plus Printers

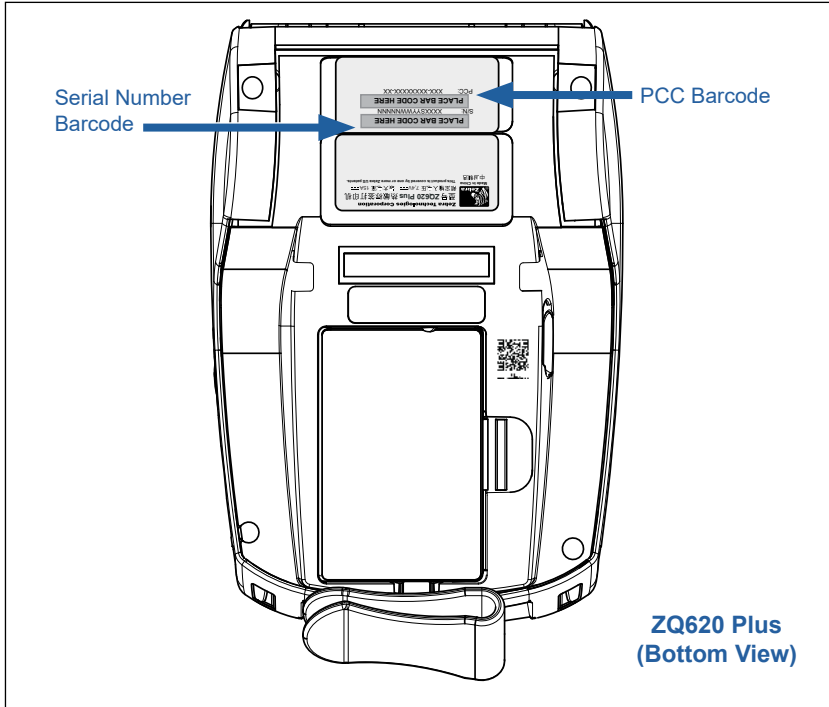

Important • Due to compliance and customs restraints, an integrator may not be able to ship a printer purchased in one country to another country based on the limitations imposed by regional SKUs. The country code identified in the printer SKU determines the area of the world in which the printer can be used.

Battery Disposal



The EPA certified RBRC® Battery Recycling Seal on the Lithium-Ion (Li-Ion) battery supplied with your printer indicates Zebra Technologies Corporation is voluntarily participating in an industry program to collect and recycle these batteries at the end of their useful life, when taken out of service in the United States or Canada. The RBRC program provides a convenient alternative to placing used Li-Ion batteries into the trash or the municipal waste stream, which may be illegal in your area.



Important • When the battery is depleted, insulate the terminals with tape before disposal.

Call 1-800-8-BATTERY for information on Li-Ion battery recycling and disposal bans/restrictions in your area.

Zebra Technologies Corporation's involvement in this program is part of our commitment to preserving our environment and conserving our natural resources.

Outside North America, please follow local battery recycling guidelines.

Product Disposal

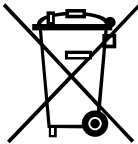

The majority of this printer's components are recyclable. Do not dispose of any printer components in unsorted municipal waste. Please dispose of the battery according to your local regulations, and recycle the other printer components according to your local standards.

For more information, go to: zebra.com/environment.

Alert Messages

The ZQ6 Plus printers display the following alert messages to inform you of various fault conditions that might occur.

Message	Type	Color
AckAlertOptionBoardInvalid	WARNING	YELLOW
AckAlertYN1	INFO	GREEN
AckAlertNoUsbDriveFound	WARNING	YELLOW
AckAlertAllFilesPrinted	INFO	GREEN
AckAlertAllFilesStored	INFO	GREEN
AckAlertTooManyUsbHostDevices	WARNING	YELLOW
AckAlertUnsupportedUsbHostDevice	WARNING	YELLOW
AckAlertUnsupportedUsbHostFilesystem	WARNING	YELLOW
AckAlertErrorPrintingFile	ERROR	RED
AckAlertErrorStoringFile	ERROR	RED
AckAlertErrorPrintingFileContinue	ERROR	RED
AckAlertErrorStoringFileContinue	ERROR	RED
AckAlertFirmwareFoundContinue	INFO	GREEN
AckAlertUsbMirrorAutoPrompt	INFO	GREEN
AckAlertUseUsbMemoryDevicePrompt	INFO	GREEN
AckAlertBluetoothPairingPassKey	INFO	GREEN
AckAlertInvalidZplTemplateFile	ERROR	RED
AckAlertCoreDumpPresent	INFO	GREEN
AckAlertInvalidComplianceFile	ERROR	RED
AckAlertHeadElementTestFailed	ERROR	RED
AckAlertUsbPowerError	ERROR	RED
AckAlertFileSystemWriteError	ERROR	RED
AckAlertAvalancheError	ERROR	RED
AckAlertAvalancheTextMessage	INFO	GREEN
AvalanchePerformingUpdate	INFO	GREEN
AvalancheUpdateComplete	INFO	GREEN
BatteryHealthReplace	WARNING	YELLOW
BatteryHealthNearDeath	WARNING	YELLOW
BatteryHealthShutdown	ERROR	RED
BatteryAuthenticationFail	ERROR	RED
BatteryOverTemp	WARNING	YELLOW
BatteryUnderTemp	WARNING	YELLOW

Message	Type	Color
BatteryChargeFault	ERROR	RED
BatteryLow	WARNING	YELLOW
BatteryRemoved	WARNING	YELLOW
BadFirmwareDownload	ERROR	RED
BatchCount	INFO	GREEN
BluetoothPinInvalid	ERROR	RED
BluetoothPairing	INFO	GREEN
BluetoothPairingAccepted	INFO	GREEN
BluetoothPairingRejected	ERROR	RED
BluetoothPairingFailed	ERROR	RED
BluetoothDisplayPasskey	INFO	GREEN
CancelAll	INFO	GREEN
CancelOne	INFO	GREEN
CalibrationMediaInput	INFO	GREEN
CalibrationMediaRunning	INFO	GREEN
CalibrationRibbonRunning	INFO	GREEN
CalibrationRibbonInput	INFO	GREEN
CountryCodeNotSelected	WARNING	YELLOW
CutError	ERROR	RED
DownloadingOptionBoardFirmware	INFO	GREEN
DownloadingFirmware	INFO	GREEN
HeadOpen	ERROR	RED
HeadOverTemp	WARNING	YELLOW
HeadUnderTemp	WARNING	YELLOW
HeadCold	WARNING	YELLOW
HeadAuthenticationFailed	ERROR	RED
HeadThermistorFault	ERROR	RED
HeadIdentificationFailed	ERROR	RED
HeadMaintenanceNeeded	INFO	GREEN
MediaLow	INFO	GREEN
MediaOut	ERROR	RED
MirroringFile	INFO	GREEN
Mirroring	INFO	GREEN
MirroringApplication	INFO	GREEN
MirroringCommands	INFO	GREEN
MirroringFeedback	INFO	GREEN

Message	Type	Color
MirrorProcessingFinished	INFO	GREEN
MotorOverTemp	WARNING	YELLOW
MagCardReaderActive	INFO	GREEN
OutOfMemoryStoringGraphic	ERROR	RED
OutOfMemoryStoringFont	ERROR	RED
OutOfMemoryStoringFormat	ERROR	RED
OutOfMemoryStoringBitmap	ERROR	RED
OperationProgress	INFO	GREEN
OptionalAlertKeyP2	INFO	GREEN
PaperJam	WARNING	YELLOW
PasswordInvalid	ERROR	RED
PauseRequest	WARNING	YELLOW
PrinterError	ERROR	RED
PowerOff	INFO	GREEN
PowerReset	INFO	GREEN
PowerSleep	INFO	GREEN
PowerSupplyError	ERROR	RED
PrintHeadShutdown	WARNING	YELLOW
ReplaceHead	ERROR	RED
RfidError	ERROR	RED
RfidNotPresent	INFO	GREEN
RibbonOut	ERROR	RED
RibbonIn	WARNING	YELLOW
RibbonLow	INFO	GREEN
StartingApplication	INFO	GREEN
WlanLossSignal	WARNING	YELLOW
WlanResumeSignal	INFO	GREEN
WlanInvalidChannels	ERROR	RED
WlanInvalidSecurityMode	ERROR	RED
WmlError	ERROR	RED
WritingFirmwareToFlash	INFO	GREEN

Using Zebra.com

The following examples illustrate the search function on Zebra's website for finding specific documents and downloads.

Example: Find the ZQ6 Plus User Guides.

1. Go to zebra.com/support.
2. Scroll down and type a printer name in search box.

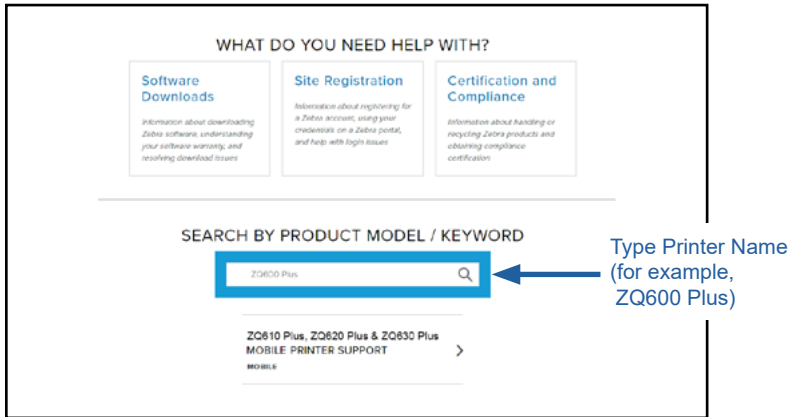

3. Scroll down on the ZQ6 Plus page for printer support pages.

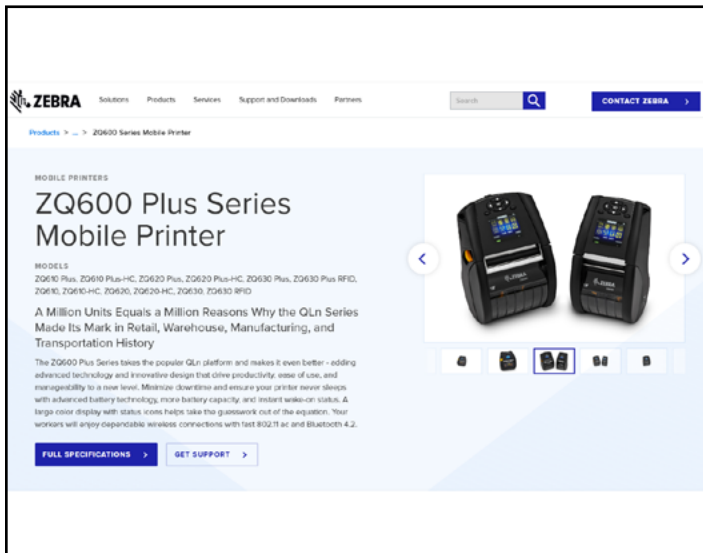

4. Click **Get Support** for How-To videos, manuals, drivers, firmware and software & utilities.

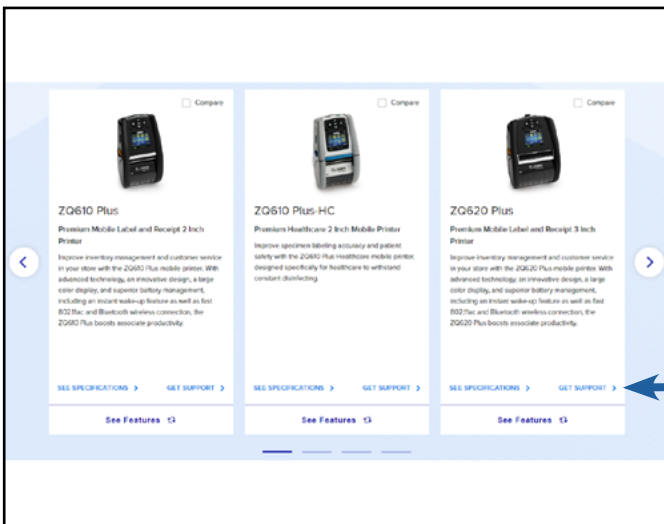

5. Click an expanded menu for various support topics.

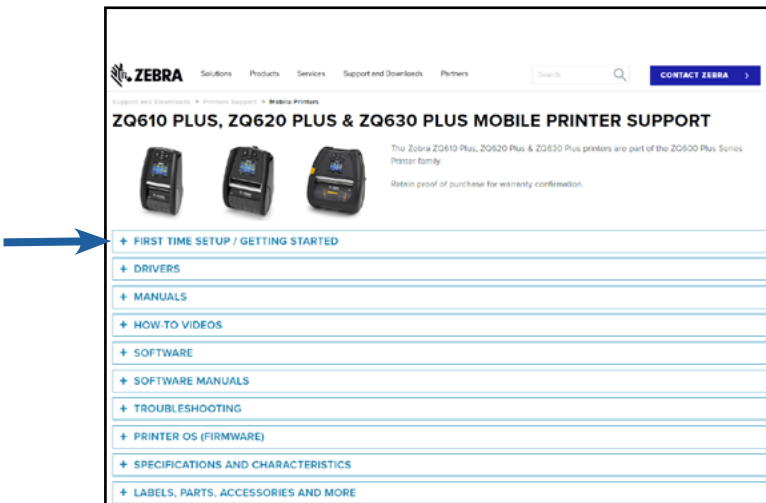

Appendix I

Contact Support

Go to zebra.com/contact to contact us with a specific problem with your printer, and have the following information on hand:

- Model number/type (for example, ZQ620 Plus)
- Unit serial number (see Appendix E)
- Product Configuration Code (PCC) (see Appendix E)

Contact and request support, or find your solution by:

- Submitting an online inquiry
- Requesting repair services
- Searching through the Discussion Forum
- Requesting support for Matrox Imaging Support products
- Initiating a chat through Services Virtual Assistant

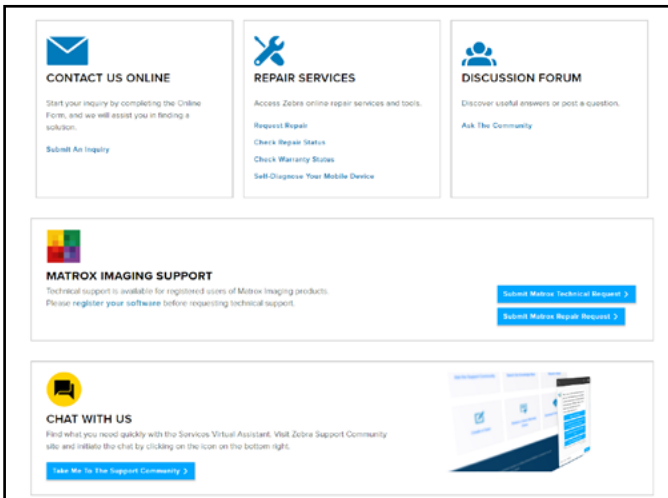

To contact support by phone, select your location from the drop-down menu and use the numbers provided.



Index

A

- Accessories 21–90, 82–139
- AC Power Adapter 24
- Adaptive Print Performance 48
- Alert Messages 45
- Appendix A, USB Cables 109
- Appendix B, Media Supplies 111
- Appendix C, Maintenance Supplies 111
- Appendix D, Parameters Menus 112
- Appendix E, Serial and PCC 132
- Appendix F, Battery Disposal 133
- Appendix G, Alert Messages 134
- Appendix H, Using Zebra.com 137
- Appendix I, Product Support 139

B

- Battery, health 21
- Battery, installing 17
- Battery pack
 - Power Precision 11
- Battery Safety 20
- Belt Clip 82
- Black Mark Dimensions 77
- Bluetooth 71
- Bluetooth, minimum security modes 73
- Bluetooth, security modes 72

C

- Cable Communication 51
- Charger, battery 20–30
 - 1-Slot Charger 29
 - 3-Slot Charger 30
 - AC Power Adapter 24
 - Ethernet Cradles 25
 - Smart Charger 2 21
 - UCLI72 Quad Charger 22
- Charger Safety 20
- Communication Port 100
- Communications Diagnostics 92
- Configuration Label, sample 94

- CPCL Font and Bar Code
 - Specifications and Commands 99
- Cradles, Ethernet and Charging 25

D

- Designing Labels 75
- Dimensions, ZQ610 105
- Dimensions, ZQ620 103
- Document Conventions 8
- Draft Mode 48

E

- Ethernet Cradles 25

G

- General Cleaning Instructions 86
- Getting Ready to Print 17

H

- Healthcare Printers 34
- Home Menu Screen 42
- Home Screen Icons & Parameters 44

I

- Installing the Battery 17
- Introduction to the ZQ6 Printers 9

L

- Label Areas 77
- Label Design Examples 78
- LCD Control Panel 39, 89

M

- Made for iPhone (MFi) 13
- Media, loading 31
- Mounting Dimensions ZQ610 106
- Mounting Dimensions ZQ620 104

N

- Near Field Communication (NFC) 14, 80

P

- Power Save Mode 47
- Power-Up Sequences 46
- Preventive Maintenance 86
- Printer Status Icons 40
- Printing Method
 - Direct Thermal 12
- Programming language
 - CPCL 9

Q

- QR Code 13
- Quad Charger, cycle times 23
- Quad Charger, UCLI72-4 22

R

- RS-232C Communications 51

S

- Shoulder Strap 83
- Sleep Mode 47
- Smart Battery, PowerPrecision+ 11
- Smart Charger-2 (SC2) Single Battery Charger 21
- Soft Case 84
- Specifications, label 98
- Specifications, memory and communications 97
- Specifications, physical, environmental and electrical 102
- Specifications, printing 97
- Status Bar Icons 40

T

- Troubleshooting, tests 92
- Troubleshooting, topics 90

V

- Verify printer is working 49

W

- Wearing the Printer 82
- WLAN, overview 73

Z

- Zebra Setup Utilities 63
- ZPL Font and Bar Code Specifications and Commands 99
- ZQ6 Accessories 107



Zebra Technologies Corporation
3 Overlook Point
Lincolnshire, IL 60069 USA
P: +1 847.634.6700 or F: +1 847.913.8766

ZEBRA