



## Zebra SP20

Pequeno, Portátil e de fácil instalação, o Leitor Fixo Zebra SP20 é o novo leitor da Zebra, atualizado e com a qualidade Zebra de leitura reconhecida internacionalmente, é indicado para vários ambientes comerciais e até industriais.



# SP20 Series

Hands-Free Scanner



**ZEBRA**

## Product Reference Guide

2025/11/14

ZEBRA and the stylized Zebra head are trademarks of Zebra Technologies Corporation, registered in many jurisdictions worldwide. All other trademarks are the property of their respective owners. ©2025 Zebra Technologies Corporation and/or its affiliates. All rights reserved.

Information in this document is subject to change without notice. The software described in this document is furnished under a license agreement or nondisclosure agreement. The software may be used or copied only in accordance with the terms of those agreements.

For further information regarding legal and proprietary statements, please go to:

SOFTWARE: [zebra.com/informationpolicy](https://zebra.com/informationpolicy).

COPYRIGHTS: [zebra.com/copyright](https://zebra.com/copyright).

PATENTS: [ip.zebra.com](https://ip.zebra.com).

WARRANTY: [zebra.com/warranty](https://zebra.com/warranty).

END USER LICENSE AGREEMENT: [zebra.com/eula](https://zebra.com/eula).

## Terms of Use

### Proprietary Statement

This manual contains proprietary information of Zebra Technologies Corporation and its subsidiaries ("Zebra Technologies"). It is intended solely for the information and use of parties operating and maintaining the equipment described herein. Such proprietary information may not be used, reproduced, or disclosed to any other parties for any other purpose without the express, written permission of Zebra Technologies.

### Product Improvements

Continuous improvement of products is a policy of Zebra Technologies. All specifications and designs are subject to change without notice.

### Liability Disclaimer

Zebra Technologies takes steps to ensure that its published Engineering specifications and manuals are correct; however, errors do occur. Zebra Technologies reserves the right to correct any such errors and disclaims liability resulting therefrom.

### Limitation of Liability

In no event shall Zebra Technologies or anyone else involved in the creation, production, or delivery of the accompanying product (including hardware and software) be liable for any damages whatsoever (including, without limitation, consequential damages including loss of business profits, business interruption, or loss of business information) arising out of the use of, the results of use of, or inability to use such product, even if Zebra Technologies has been advised of the possibility of such damages. Some jurisdictions do not allow the exclusion or limitation of incidental or consequential damages, so the above limitation or exclusion may not apply to you.

# Contents

<b>About This Guide.....</b>	<b>14</b>
Configurations.....	14
Accessories.....	14
Notational Conventions.....	15
Icon Conventions.....	15
Service Information.....	16
<b>Getting Started.....</b>	<b>17</b>
Unpacking the Scanner.....	17
Features.....	18
Installing the SP20 Stand.....	19
Mounting the SP20 to a Stand.....	20
Mounting Options.....	22
Mounting Dimensions.....	23
Mounting the SP20.....	25
Host Interfaces.....	27
<b>123Scan and Software Tools.....</b>	<b>28</b>
123Scan.....	28
Communication with 123Scan.....	29
123Scan Requirements.....	29
123Scan Information.....	29
Scanner SDK, Other Software Tools, and Videos.....	30
Advanced Data Formatting.....	30
Multicode Data Formatting.....	31

Multicode Data Formatting Use.....	31
MDF for Best Practices.....	32
Preferred Symbol.....	33
<b>Data Capture.....</b>	<b>34</b>
Scanning.....	34
Active Scan Area.....	34
Beeper and LED Indicators.....	35
<b>Maintenance and Troubleshooting.....</b>	<b>38</b>
Maintenance.....	38
Known Harmful Ingredients.....	38
Approved Cleaners.....	38
Cleaning the Scanner.....	39
Troubleshooting.....	39
Dump Scanner Parameters.....	41
<b>Specifications.....</b>	<b>43</b>
Electrical Interface.....	43
Typical Decode Ranges.....	44
<b>USB Interface.....</b>	<b>45</b>
USB Parameter Defaults.....	45
USB Device Type.....	46
USB Barcodes with Unknown Characters.....	48
Product ID (PID) Type.....	48
Product ID (PID) Value.....	49
ECLevel.....	49
TGCS (IBM) USB Beep Directive.....	49
TGCS (IBM) USB Barcode Configuration Directive.....	50
IBM Scanner Generic Management Information.....	50
IBM Scanner Vendor Specific Management Information.....	51
TGCS (IBM) USB Direct I/O Beep.....	51

USB Convert Unknown to Code 39.....	52
TGCS (IBM) USB Specification Version.....	52
USB IBM Long Direct I/O.....	53
IBM Flash Update.....	53
USB Keystroke Delay.....	53
USB Caps Lock Override.....	54
Keypad Emulation.....	54
Keypad Emulation with Leading Zero.....	55
USB Function Key Mapping.....	55
USB Simulated Caps Lock.....	56
USB Convert Case.....	56
USB Keyboard FN1 Substitution.....	57
USB Polling Interval.....	57
USB Quick Keypad Emulation.....	59
USB Fast HID.....	60
Symbol Native API (SNAPI) Status Handshaking.....	60
Bluetooth SPP Beep on <BEL>.....	61
USB CDC Host Variant.....	61
USB Static CDC.....	62
<b>RS-232 Interface.....</b>	<b>63</b>
RS-232 Host-Specific Code ID Characters.....	63
RS-232 Parameter Defaults.....	65
RS-232 Host Types.....	65
RS-232 Baud Rate.....	67
RS-232 Parity.....	68
Check Receive Errors.....	69
RS-232 Stop Bits.....	69
Data Bits.....	69
Hardware Handshaking.....	70
Software Handshaking.....	72
RS-232 Barcodes with Unknown Characters.....	73
RS-232 Host Serial Response Timeout.....	73
RTS Line State.....	74

Beep on <BEL>.....	74
Intercharacter Delay.....	75
Datalogic Host Format.....	75
Datalogic Supported Commands.....	76
Nixdorf Beep/LED Options.....	76
NCR Use Prefix.....	77
NCR Use Block Check Character (BCC).....	77
NCR Prefix.....	78
NCR Suffix.....	78
NCR 2D Label-ID Mode.....	78
<b>SSI Interface.....</b>	<b>80</b>
Communication.....	80
SSI Commands.....	80
SSI Transactions.....	81
General Data Transactions.....	81
Decoded Data Transmission.....	82
Communication Summary.....	83
RTS/CTS Lines.....	83
ACK/NAK Option.....	84
Number of Data Bits.....	84
Serial Response Timeout.....	84
Retries.....	84
Baud Rate, Stop Bits, Parity, Response Timeout, ACK/NAK Handshaking.....	84
Errors.....	84
SSI Communication Notes.....	84
Encapsulation of RSM Commands/Responses over SSI.....	85
Example Transaction.....	85
Setting SSI Parameters.....	87
SSI Scanning Sequence Examples.....	87
SSI Errors While Scanning.....	87
SSI Interface Parameter Defaults.....	87
SSI Host Parameters.....	88

<b>User Preferences and Miscellaneous Options.....</b>	<b>97</b>
Setting User Preference Parameters.....	97
User Preference Scanning Sequence Examples.....	97
User Preference Errors While Scanning.....	97
User Preferences Parameter Defaults.....	98
User Preferences.....	99
<b>Image Capture Preferences.....</b>	<b>116</b>
Setting Image Capture Parameters.....	116
Image Capture Scanning Sequence Examples.....	116
Image Capture Errors While Scanning.....	116
Image Capture Preferences Parameter Defaults.....	116
Image Capture Preferences Modes and Parameters.....	118
Operational Modes.....	118
Presentation Mode Field of View.....	118
Image Capture Autoexposure.....	119
Fixed Exposure.....	119
Analog and Digital Gain.....	120
Digital Gain.....	120
Image Capture Illumination.....	120
Image Brightness (Target White).....	121
Image Size (Number of Pixels).....	121
Image Enhancement.....	122
Image File Format Selector.....	123
Bits Per Pixel.....	123
Image Rotation.....	124
JPEG Image Options.....	124
JPEG Size Value.....	125
JPEG Quality Value.....	125
Gain/Exposure Priority for Snapshot Mode.....	126
Snapshot Mode Timeout.....	126
Silence Operational Mode Changes.....	127
Image Cropping.....	127
Crop to Pixel Addresses.....	128

<b>Symbologies.....</b>	<b>130</b>
Symbology Parameter Defaults.....	130
Enable/Disable All Code Types.....	135
Default Parameters.....	135
Preferred Symbol.....	136
UPC-A.....	136
UPC-E.....	137
UPC-E1.....	137
EAN-8/JAN-8.....	138
EAN-13/JAN-13.....	138
Bookland EAN.....	138
Bookland ISBN Format.....	139
ISSN EAN.....	139
User-Programmable Supplementals.....	140
UPC/EAN/JAN Supplemental Redundancy.....	140
UPC/EAN/JAN Supplemental AIM ID Format.....	141
Linear UPC/EAN.....	142
Transmit UPC-A Check Digit.....	142
Transmit UPC-E Check Digit.....	143
Transmit UPC-E1 Check Digit.....	143
UPC-A Preamble.....	143
UPC-E Preamble.....	144
UPC-E1 Preamble.....	145
Convert UPC-E to UPC-A.....	145
Convert UPC-E1 to UPC-A.....	146
EAN/JAN Zero Extend.....	146
Coupon Report.....	147
UPC Reduced Quiet Zone.....	147
Set Lengths for Code 128.....	148
Decode UPC/EAN/JAN Supplementals.....	149
Code 128.....	152
GS1-128 (formerly UCC/EAN-128).....	152
ISBT 128.....	153
ISBT Concatenation.....	153

Check ISBT Table.....	154
ISBT Concatenation Redundancy.....	154
Code 128 <FNC4>.....	155
Code 128 Reduced Quiet Zone.....	155
Code 39.....	156
Convert Code 39 to Code 32.....	156
Code 32 Prefix.....	157
Set Lengths for Code 39.....	157
Code 39 Check Digit Verification.....	158
Transmit Code 39 Check Digit.....	159
Code 39 Full ASCII Conversion.....	159
Set Lengths for Code 93.....	160
Code 39 Reduced Quiet Zone.....	161
Transmit Code 39 Start/Stop Characters.....	161
Code 93.....	162
Set Lengths for Interleaved 2 of 5 (I 2 of 5).....	162
Interleaved 2 of 5 (I 2 of 5).....	163
Interleaved 2 of 5 (I 2 of 5) Check Digit Verification.....	164
Transmit I 2 of 5 Check Digit.....	164
Convert Interleaved 2 of 5 (I 2 of 5) to EAN-13.....	165
Febraban.....	165
Interleaved 2 of 5 (I 2 of 5) Security Level.....	166
Set Lengths for Discrete 2 of 5 (D 2 of 5).....	167
Interleaved 2 of 5 (I 2 of 5) Reduced Quiet Zone.....	168
Set Lengths for Codabar.....	169
Discrete 2 of 5 (D 2 of 5).....	170
Codabar (NW - 7).....	170
CLSI Editing.....	171
NOTIS Editing.....	171
Codabar Security Level.....	172
Codabar Upper or Lower Case Start/Stop Characters.....	173
Codabar Mod 16 Check Digit Verification.....	173
Transmit Codabar Check Digit.....	173
MSI.....	174

Set Lengths for MSI.....	174
MSI Check Digits.....	175
Transmit MSI Check Digit(s).....	176
MSI Check Digit Algorithm.....	177
MSI Reduced Quiet Zone.....	177
Chinese 2 of 5.....	177
Korean 3 of 5.....	178
Inverse 1D.....	178
GS1 DataBar Omnidirectional (formerly GS1 DataBar-14).....	179
GS1 DataBar Limited.....	179
GS1 DataBar Expanded.....	180
Convert GS1 DataBar to UPC/EAN/JAN.....	180
GS1 DataBar Security Level.....	181
GS1 DataBar Limited Margin Check.....	182
GS1 Digital Link.....	183
GS1 Digital Link Mode.....	183
GS1 Digital Link Prioritization Timeout.....	184
Redundancy Level.....	184
Security Level.....	185
1D Quiet Zone Level.....	186
Intercharacter Gap Size.....	187
GS1-128 Emulation Mode for UCC/EAN Composite Codes.....	187
PDF417.....	188
MicroPDF417.....	188
Code 128 Emulation.....	188
Data Matrix.....	189
GS1 Data Matrix.....	190
Data Matrix Inverse.....	190
Decode Data Matrix Mirror Images.....	190
QR Code.....	191
Weblink QR.....	191
GS1 QR.....	192
MicroQR.....	192
Linked QR Mode.....	193

Aztec.....	193
Aztec Inverse.....	194
Han Xin.....	194
Han Xin Inverse.....	195
Grid Matrix.....	195
Grid Matrix Inverse.....	196
Grid Matrix Mirrored.....	196
DotCode.....	197
DotCode Prioritize.....	197
DotCode Inverse.....	198
DotCode Mirrored.....	198
DotCode Erasure Limit.....	199
<b>Numeric Barcodes.....</b>	<b>200</b>
Cancel.....	201
<b>Alphanumeric Barcodes.....</b>	<b>202</b>
Cancel.....	202
Alphanumeric Barcodes.....	202
<b>ASCII Character Sets.....</b>	<b>215</b>
<b>Programming Reference.....</b>	<b>223</b>
Symbol Code Identifiers.....	223
AIM Code Identifiers.....	224
<b>Communication Protocol Functionality.....</b>	<b>229</b>
<b>Country Codes.....</b>	<b>230</b>
USB and Keyboard Wedge Country Keyboard Types (Country Codes).....	230
Country Code Barcodes.....	230

<b>Country Code Pages.....</b>	<b>242</b>
Country Code Page Defaults.....	242
Country Code Page Barcodes.....	245
<b>CJK Decode Control.....</b>	<b>252</b>
CJK Control Parameters.....	252
Unicode Output Control.....	252
CJK Output Method to Windows Host.....	252
Non-CJK UTF Barcode Output.....	254
Unicode/CJK Decode Setup with Windows Host.....	256
Setting Up the Windows Registry Table for Unicode Universal Output.....	256
Adding CJK IME on Windows.....	256
Selecting the Simplified Chinese Input Method on the Host.....	257
Selecting the Traditional Chinese Input Method on the Host.....	257
<b>Non-Parameter Attributes.....</b>	<b>259</b>
Model Number.....	259
Serial Number.....	259
Date of Manufacture.....	259
Date of First Programming.....	260
Configuration Filename.....	260
Beeper/LED.....	261
Parameter Defaults.....	261
Beep on Next Bootup.....	262
Reboot.....	262
Host Trigger Session.....	262
Firmware Version.....	262
Scankit Version.....	263
<b>Sample Barcodes.....</b>	<b>264</b>
Sample Code 39.....	264
Sample Code 93.....	264
Sample UPC/EAN.....	264

Sample Code 128.....	266
Sample Interleaved 2 of 5.....	266
Sample Chinese 2 of 5.....	266
Sample Matrix 2 of 5.....	267
Sample Korean 3 of 5.....	267
Sample GS1 DataBar.....	267
Sample PDF417.....	268
Sample Data Matrix.....	268
Sample Aztec.....	268
Sample Grid Matrix.....	268
Sample GS1 DataBar Truncated.....	269
Sample GS1 DataBar Stacked OmniDirectional.....	269
Sample GS1 DataBar Expanded Stacked Barcode.....	270
Sample GS1 DataBar Expanded.....	270
MSI Two Check Digits.....	270
Sample Code 11 with 2 Check Digits.....	270
Sample GS1-128.....	271
2D Symbologies.....	271
Sample GS1 Data Matrix.....	271
Sample QR Code.....	271
Sample GS1 QR.....	272
Sample MicroQR.....	272
Sample Han Xin.....	273
Sample Grid Matrix.....	273

# About This Guide

The SP20 Product Reference Guide provides general instructions for setting up, operating, maintaining, programming, and troubleshooting the SP20 cube scanner.

## Configurations

**Table 1** SP20 Scan Module Configurations

Configuration	Description
SP2002-SR00004ZZWW	SP2002: Single Plane Area Imager, Cube Only, Standard Range, Midnight Black
SP2002-SR00004ZZCN	SP2002: Single Plane Area Imager, Cube Only, Standard Range, Midnight Black – China only
SP2002-SR400000SGW	SP2002-SR Black with Stand (Cable Not Included) KIT: SP2002-SR00004ZZWW Scanner, STND-AD0020-04
SP2002-SR400000SGC	SP2002-SR Black with Stand (Cable Not Included) KIT: SP2002-SR00004ZZCN Scanner, STND-AD0020-04 – China Only

## Accessories

This section presents the accessories of the SP20 and their respective descriptions. This includes multiple cable types such as USB and RS-232, as well as mounting options and power supplies.

Part Number	Description
<b>USB Cables</b>	
CBA-HF-UA00-020ZA	Shielded 0.6 m (2 ft.) straight, black USB-A cable.
CBA-HF-UA00-021ZA	Shielded 0.6 m (2 ft.) right-angle connector, black USB-A cable.
CBA-HF-UA00-070ZA	Shielded 2.1 m (7 ft.) straight, black USB-A cable.
CBA-HF-UA00-071ZA	Shielded 2.1 m (7 ft.) right-angle connector, black USB-A cable.
<b>RS-232 Cables</b>	
CBA-HF-RS00-070PA	Shielded 2.1 m (7 ft.) straight, black RS-232 DB9 female cable, Tx/D on 2, TTL current limit protection.

Part Number	Description
CBA-HF-RS00-071PA	Shielded 2.1 m (7 ft.) right-angle connector, black RS-232 DB9 female cable, TxD on 2, TTL current limit protection.
<b>Power Supplies</b>	
PWR-WUA5V4W0US	5 VDC, 100 - 240VAC, US/CA/MX/JP/TW power supply.
PWR-WUA5V4W04C	5 VDC, 850MA, Brazil, China, EU and Australia adapter plugs Level 6 power supply.
PWR-WUA5V4W0EU	5 V DC, 100 - 240 V AC, power supply, EU/UK.
PWR-WUA5V4W0CN	5 V DC, 100 - 240 V AC, power supply, China.
<b>Mounting Accessories</b>	
STND-AD0020-04	Adjustable Stand.
BRKT-LB0020-04	L Bracket
BRKT-FB0020-04	Flange Bracket.

## Notational Conventions

The following notational conventions make the content of this document easy to navigate.

- **Bold** text is used to highlight the following:
  - Dialog box, window, and screen names
  - Dropdown list and list box names
  - Checkbox and radio button names
  - Icons on a screen
  - Key names on a keypad
  - Button names on a screen
- Bullets (•) indicate:
  - Action items
  - List of alternatives
  - Lists of required steps that are not necessarily sequential
- Sequential lists (for example, those that describe step-by-step procedures) appear as numbered lists.

## Icon Conventions

The documentation set is designed to give the reader more visual clues. The following visual indicators are used throughout the documentation set.



**NOTE:** The text here indicates information that is supplemental for the user to know and that is not required to complete a task.



**IMPORTANT:** The text here indicates information that is important for the user to know.



**CAUTION:** If the precaution is not heeded, the user could receive a minor or moderate injury.



**WARNING:** If danger is not avoided, the user CAN be seriously injured or killed.



**DANGER:** If danger is not avoided, the user WILL be seriously injured or killed.

## Service Information

If you have a problem with your equipment, contact Zebra Global Customer Support for your region. Contact information is available at: [zebra.com/support](https://zebra.com/support).

When contacting support, please have the following information available:

- Serial number of the unit
- Model number or product name
- Software/firmware type and version number

Zebra responds to calls by email, telephone, or fax within the time limits set forth in support agreements.

If your problem cannot be solved by Zebra Customer Support, you may need to return your equipment for servicing and will be given specific directions. Zebra is not responsible for any damages incurred during shipment if the approved shipping container is not used. Shipping the units improperly can possibly void the warranty.

If you purchased your Zebra business product from a Zebra business partner, contact that business partner for support.

# Getting Started

The SP20 Series Scan Module is for customers looking for a presentation scanning option that easily integrates into their Self-Checkout (SCO) or Kiosk solution.

## Unpacking the Scanner

Remove the scanner from its packaging and inspect it for damage. The following items are included in the package:

- SP20 scanner
- Quick Start Guide
- USB or RS-232 cable (Optional - depending on the configuration purchased)
- Stand (Optional - depending on the configuration purchased)

## Features

**Figure 1** SP20 Scan Module

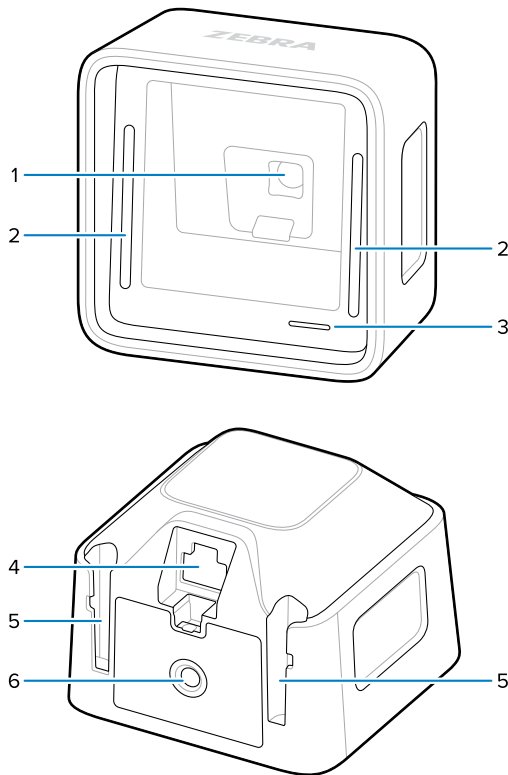

**Table 2** SP20 Scan Module

Item	Feature	Description
1	Camera aperture	Captures images for processing
2	Indicator bars	Indicate the following: <ul style="list-style-type: none"> <li>• Power on state</li> <li>• Active scan area</li> <li>• Good decode</li> </ul>
3	Sound port	Emits device status beeps
4	Host port	Provides power and communication to the scan module
5	Mounting rails	Connect the scan engine to a stand accessory
6	Threaded mount	Universal 1/4"—20 mount for attaching to third party mounting accessories

## Installing the SP20 Stand

You can install the SP20 stand on a vertical surface or tabletop.

1. Use the template below to mark the mounting holes on your tabletop or vertical surface.

You can print this template to use it as a guide. If you print this page, ensure the template measures 8 cm x 8 cm (3.15 x 3.15 in.).

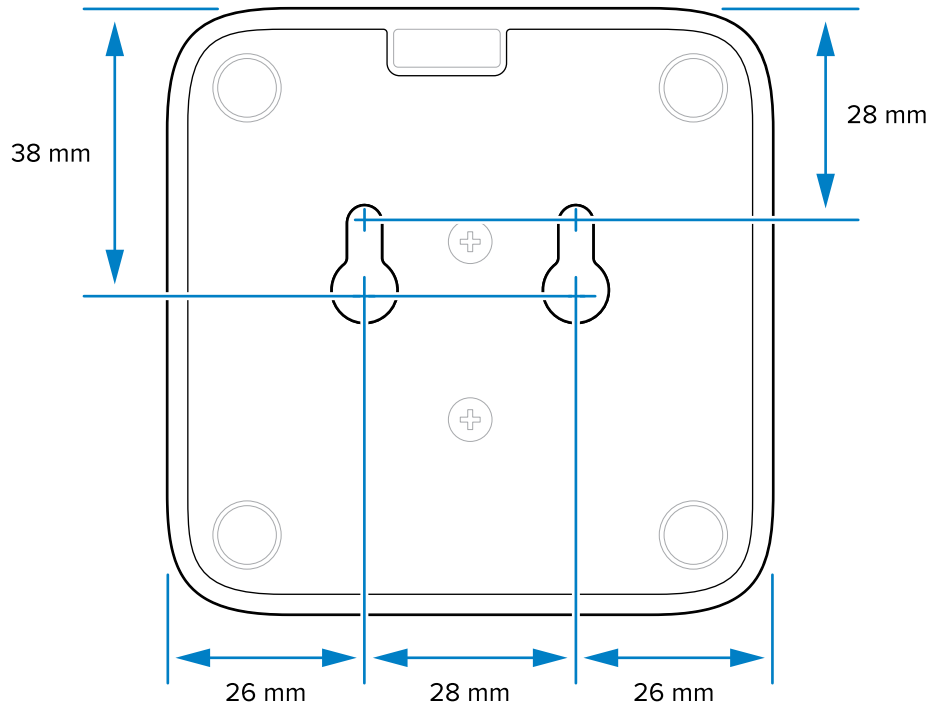

2. Use your marks to drill two pilot holes in your surface.

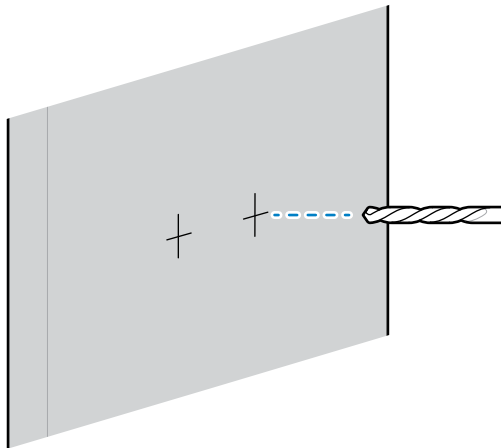

3. Affix two # 8 wood screws in the pilot holes. Leave a minimum of 2.1 mm (.08 in.) clearance between the surface and screw head.

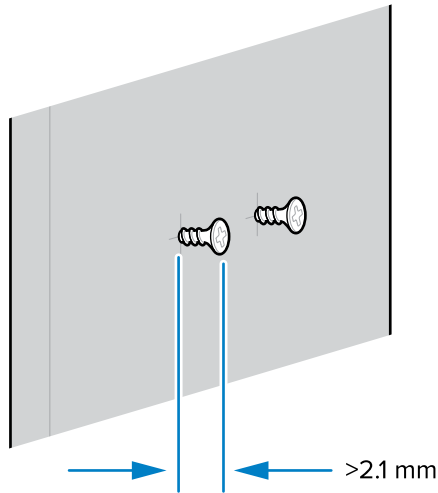

4. Hang the SP20 stand on the wood screws.

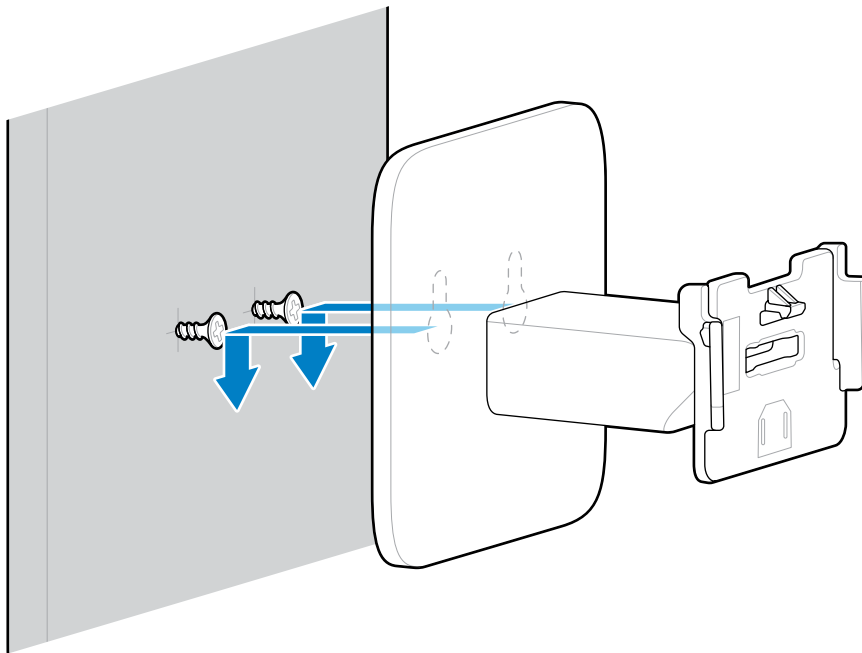

## Mounting the SP20 to a Stand

Mount the SP20 on its stand and connect it to a host device. The hands-free scanner's angle can be adjusted to suit your scanning requirements.

1. Align the mounting rails of the stand with the mounting rails on the bottom of the SP20.

2. Slide the stand's mounting rails into the SP20 until the mounting rail's edge is flush with the scanner housing.

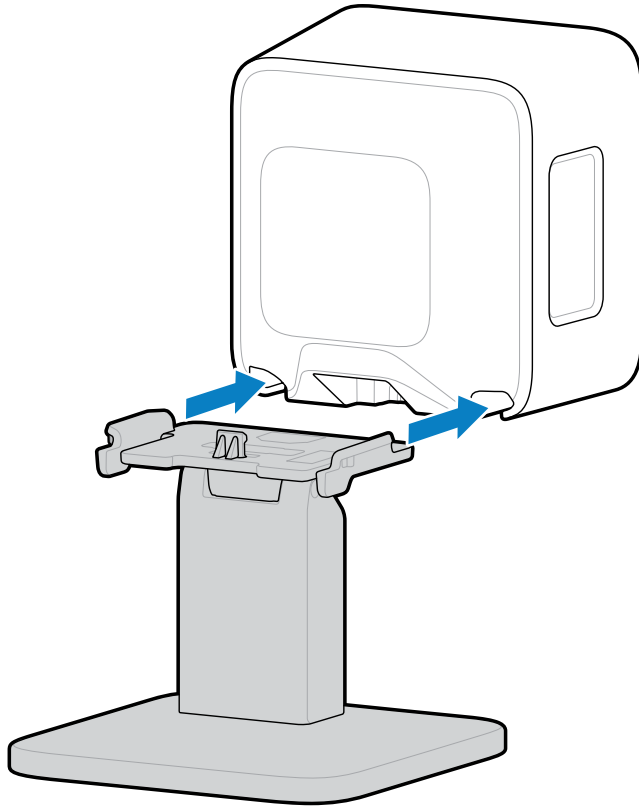

3. Connect the host cable to the scanner's host port.

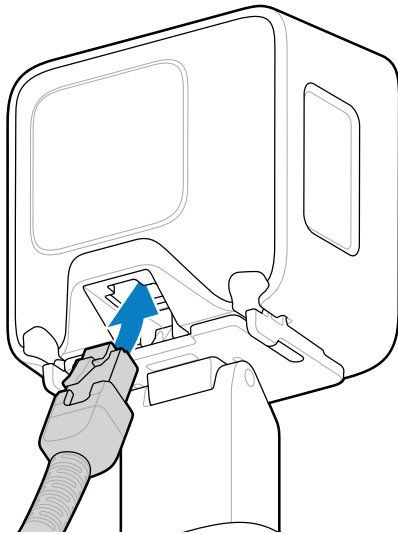

4. Connect the host cable to your host device.  
The scanner powers on.
5. Adjust the stand's angle to suit your scanning requirements.  
The stand adjusts from  $-14^{\circ}$  to  $+30^{\circ}$ .

## Mounting Options

the SP20 scanner can be mounted directly into your system, on a stand, or mounted to a flange or L-bracket accessory.

### Flange Bracket

The flange bracket holds the scanner and includes two sets of mounting options. The oval slots are compatible with a Remulak chassis and the round mounting options are reverse-compatible with panels.

**Figure 2** Flange Bracket Mounting

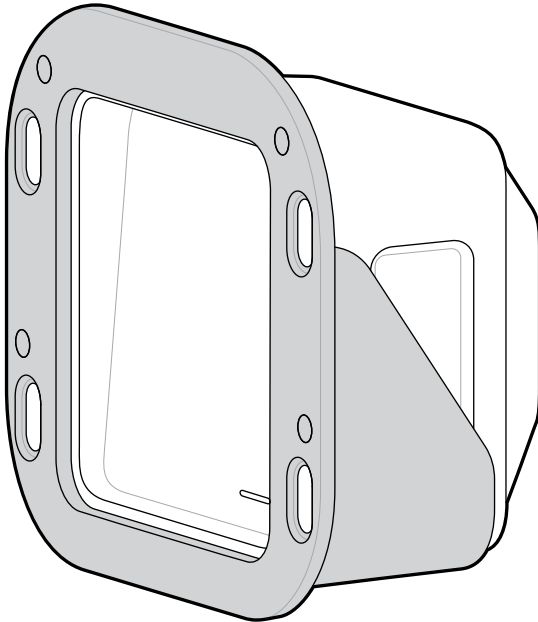

### L-Bracket

The L-bracket offers multiple mounting configurations. This ensures the SP20 can integrate successfully in many different kiosk configurations.

**Figure 3** L-Bracket Mounting Options

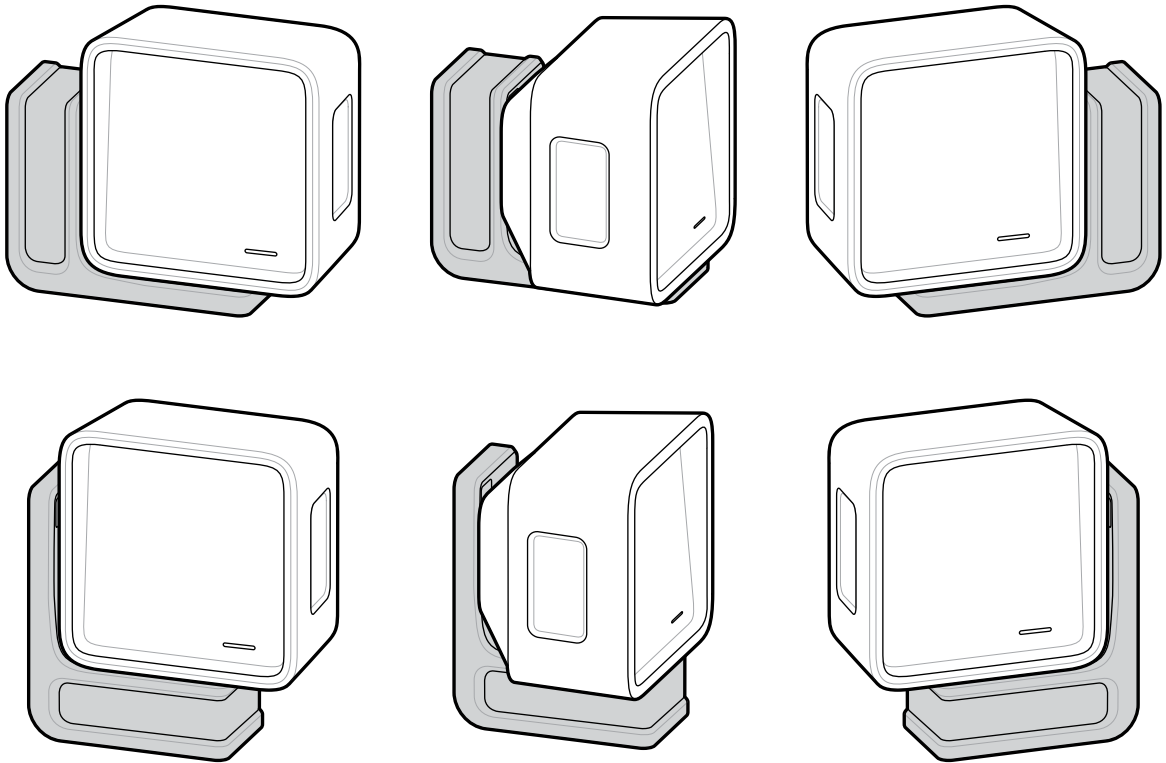

## Mounting Dimensions

Use these dimension diagrams to plan the installation of the SP20 scanner.

### Scan Engine Dimensions

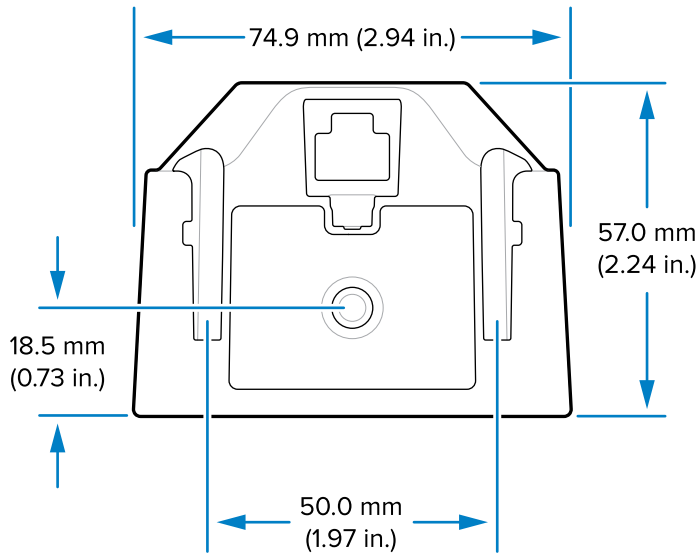

**Flange Bracket Dimensions**

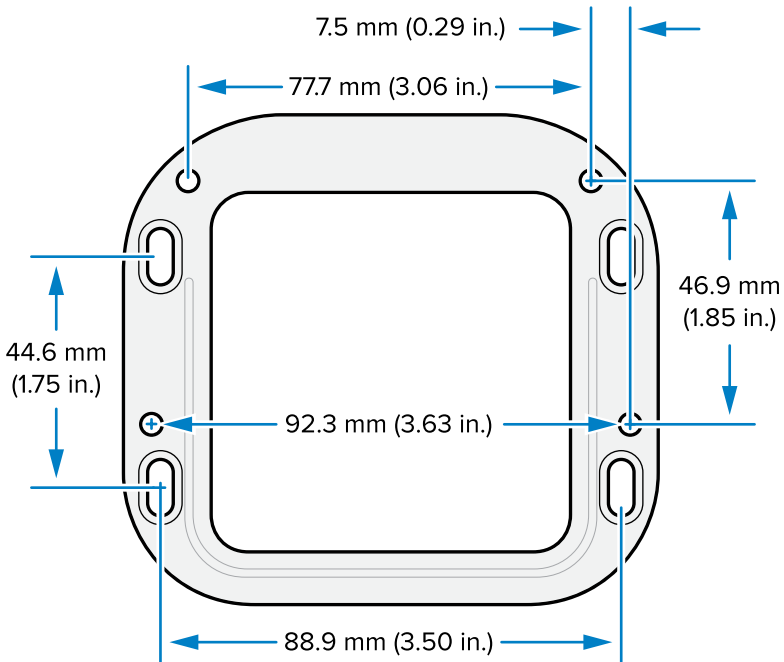

**L Bracket Dimensions**

**Figure 4** L-Bracket Dimensions

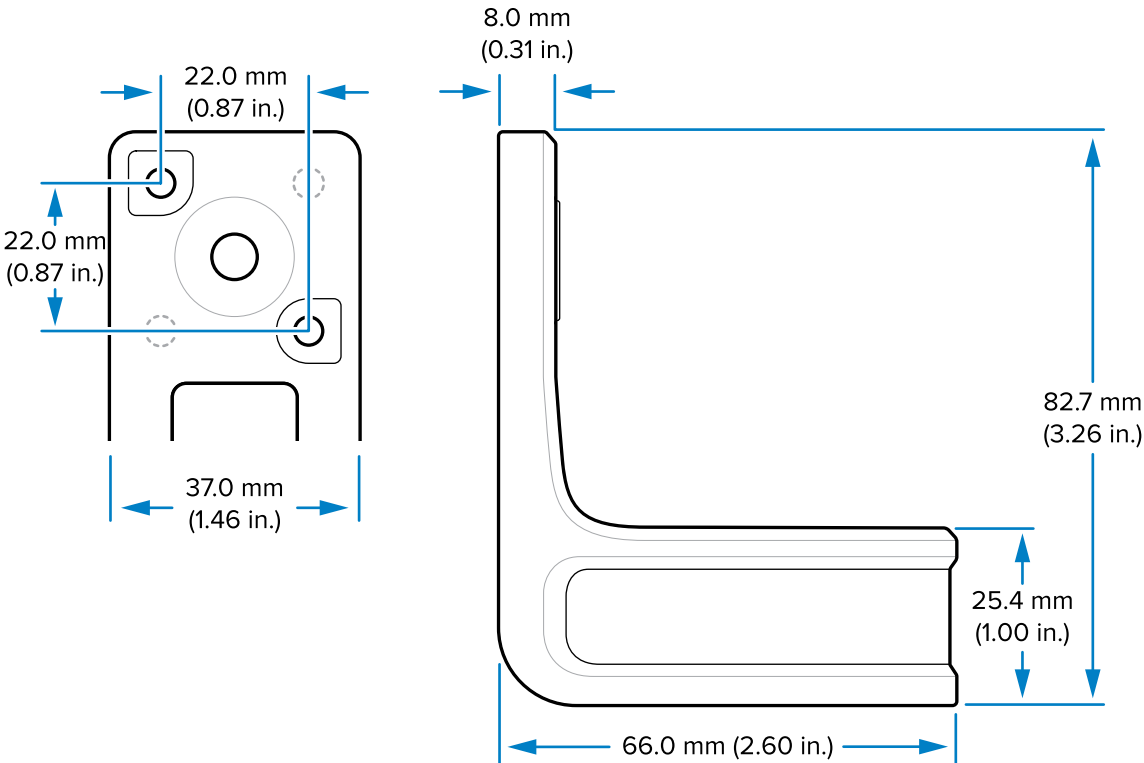

## Mounting the SP20

The SP20 mounts to a bracket accessory to enable installation in a larger system.

1. Secure the SP20 to a bracket using the 8 mm (1/4"-20) screw provided.

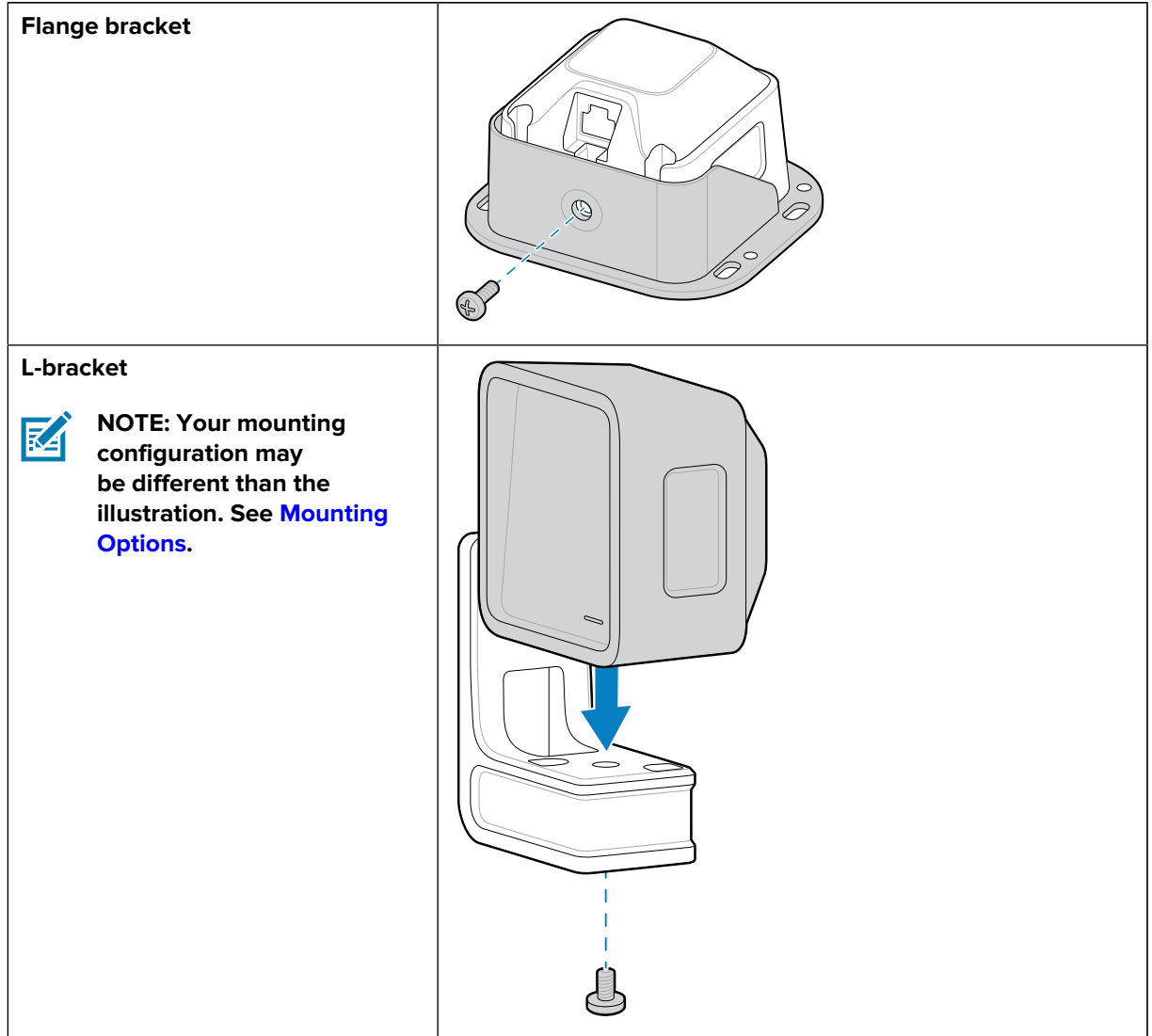

**NOTE:** Use screws that do not penetrate more than 6.7 mm (0.26 in.) into the bottom housing of the SP20.

2. Insert the host cable into the port.

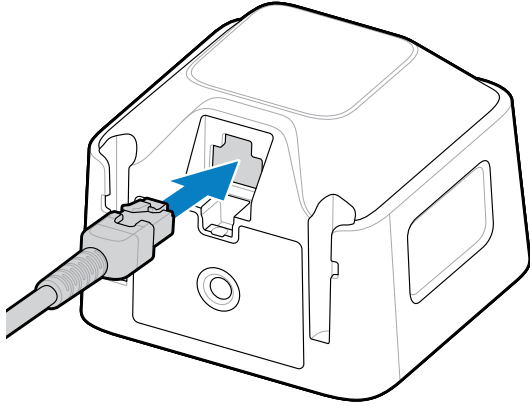

3. Select an appropriate fastener to secure the bracket to your system and use it in the relevant mounting holes on the bracket to secure the bracket to your system.

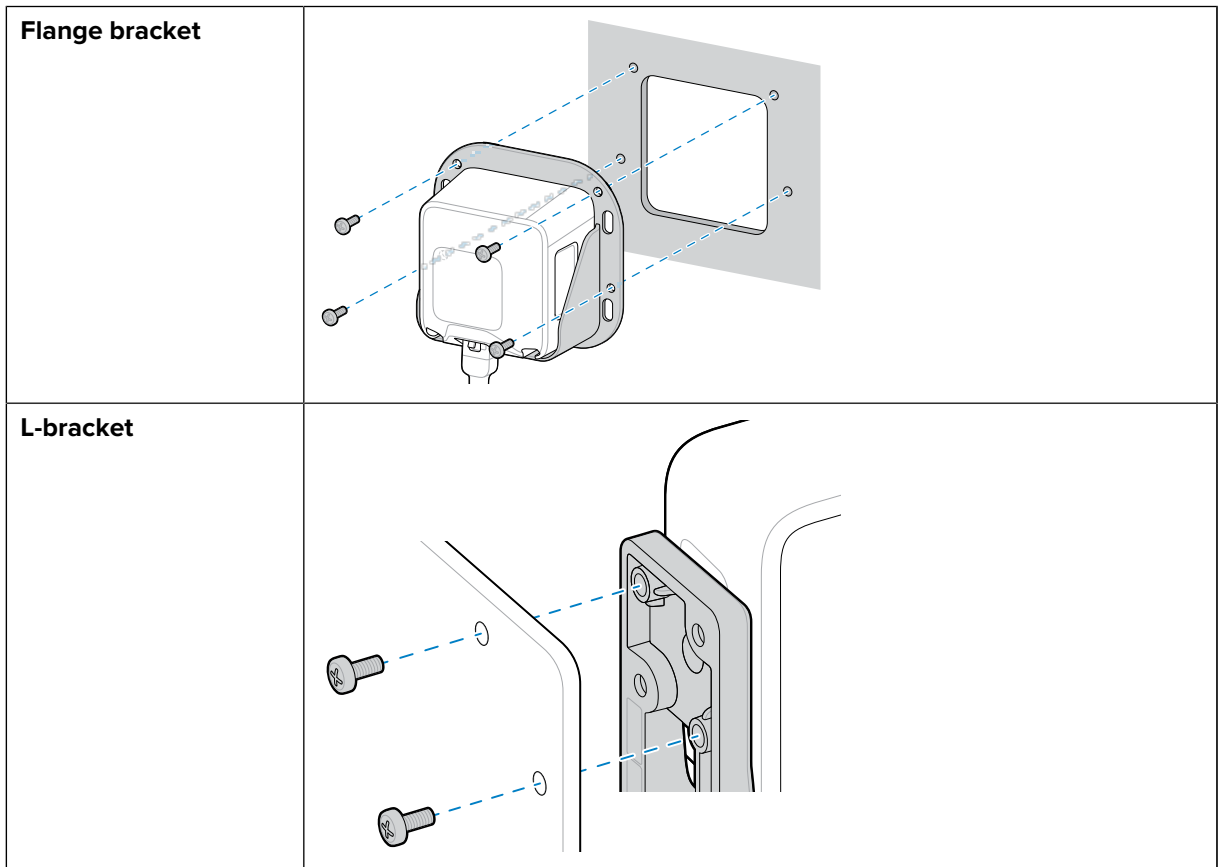

**NOTE:** Use M3 screws that do not penetrate more than 4.5 mm (0.17 in.) into the bracket housing.

## Host Interfaces

The scan module connects to a host device via either a USB or RS-232 cable. The cable powers the device and provides communication functionality between the scan module and host device.

- **USB host connection:** The scanner defaults to the HID keyboard interface type. To select other USB interface types, scan the programming barcode menus or use the Windows-based programming tool 123Scan. For international keyboard support, use [Country Codes](#) to program the keyboard interface with a USB host.
- **TTL-level RS-232 host connection:** The scanner defaults to the standard RS-232 interface type. To modify communication between the scanner and the host, scan the barcode menus or use the Windows-based programming tool 123Scan.

# 123Scan and Software Tools

This section describes the Zebra software tools available for customizing scanner operation.

## 123Scan

123Scan is a software tool from Zebra Technologies that simplifies scanner setup and more.

Intuitive enough for first-time users, the 123Scan wizard guides users through a streamlined setup process. Settings are saved in a configuration file that can be printed as a single programming barcode for scanning, emailed to a smart phone for scanning from its screen or downloaded to the scanner using a USB cable.

Through 123Scan a user can:

- Configure a scanner using a wizard.
  - Program the following scanner settings.
    - Beeper tone/volume settings.
    - Enable/disable symbologies.
    - Communication settings.
  - Modify data before transmission to a host using:
    - Advanced Data Formatting (ADF) - Scans one barcode at a time.
    - Preferred Symbol - Single out one barcode on a label of many (select scanners).
- Load parameter settings to a scanner via the following:
  - Barcode scanning.
    - Scan a paper barcode.
    - Scan a barcode from a PC screen.
    - Scan a barcode from a smart phone screen.
  - Download over a USB cable.
    - Load settings to one scanner.
    - Stage up to 10 scanners simultaneously (Powered USB Hub recommended with 0.5 amp / port).

- Validate scanner setup.
  - View scanned data within the utility's Data view screen.
  - Capture an image and save it to a PC within the utility's Data view screen.
  - Review settings using the Parameter Report.
  - Clone settings from an already deployed scanner from the Start screen.
- Upgrade scanner firmware.
  - Load settings to one scanner.
  - Stage up to 10 scanners simultaneously (Powered USB Hub recommended with 0.5 amp/port).
- View statistics, such as:
  - Asset tracking information.
  - Time and usage information.
  - Barcodes scanned by symbology.
- Generate the following reports.
  - Barcode Report - Programming barcode, relevant parameter settings, and supported scanner models.
  - Parameter Report - Parameters programmed within a configuration file.
  - Inventory Report - Scanner asset tracking information.
  - Validation Report - Scanned data from the Data view.
  - Statistics Report - All statistics retrieved from the scanner.

For more information, go to [zebra.com/123Scan](https://zebra.com/123Scan).

## Communication with 123Scan

Use a USB cable to connect the scanner to a Windows host computer running 123Scan.

## 123Scan Requirements

- Host computer running Windows 10 or 11
- Scanner
- USB cable

## 123Scan Information

Use these links to learn more about using 123Scan and Zebra software tools.

For more information on 123Scan, go to [zebra.com/123Scan](https://zebra.com/123Scan)

For a one-minute tour of 123Scan, go to [How-to Videos For Zebra Scanners](#)

To see a list of all of our software tools, go to [zebra.com/scannersoftware](https://zebra.com/scannersoftware)

## Scanner SDK, Other Software Tools, and Videos

Tackle all your scanner programming needs with our diversified set of software tools. Whether you need to stage a device or develop a fully featured application with image and data capture and asset management, these tools help you every step of the way.

To download any of the following free tools, go to: [zebra.com/scannersoftware](https://zebra.com/scannersoftware).

- 123Scan configuration utility
- SDKs
  - Scanner SDK for Windows
  - Scanner SDK for Linux
  - Scanner SDK for Android
  - Scanner SDK for iOS
- Drivers
  - OPOS driver
  - JPOS driver
  - USB CDC driver
- Scanner Management Service (SMS) for Remote Management
  - Windows
  - Linux
- Mobile Apps
  - Scanner Control App
    - Android
    - iOS
  - Scan-To-Connect Utility
    - Android
    - Windows
- How-To-Videos



**NOTE:** For a list of SDK-supported scanner functionality by communication protocol, see .

## Advanced Data Formatting

Advanced Data Formatting (ADF) allows customizing data before transmission to the host device. Use ADF to edit scanned data to suit the host application's requirements. With ADF you scan one barcode per decode session. ADF is programmed using 123Scan.

For a video on Creating an Advanced Data Formatting (ADF) Rule using 123Scan, go to [How-to Videos For Zebra Scanners](#).

For additional information, refer to the Advanced Data Formatting Programmer Guide.

## Multicode Data Formatting

Programming options include:

- Output all or specific barcodes.
- Control the barcode output sequence.
- Apply unique multicode data formatting (MDF) to each output barcode.
- Discard scanned data if all required barcodes are not present.

For more information, refer to the Multicode Data Formatting and Preferred Symbol User Guide, p/n MN-002895-xx.

For a video on Creating an Multicode Data Formatting (MDF) Rule using 123Scan, go to [How-to Videos For Zebra Scanners](#).

## Multicode Data Formatting Use

Multicode Data Formatting may yield multiple unexpected and undesired outputs when a label (most likely on a complex label) passes through the scanner's field of view. This problem happens when the complex label's barcodes can be matched by more than one group (for example, Group 1 represents all barcodes present, and Group 2 represent some barcodes present).

1. As the label is moving through the field of view, it is first partially read (some of the barcodes in the field of view in Frame 2).
2. Then, the second decode occurs as it is fully read (all the barcodes in the field of view in Frame 3).
3. This yields two different outputs (instead of the expected single output) from the presentation of a label. This problem is driven by a complex label inadvertently matching two different MDF rules/groups, thereby yielding two outputs.

**Figure 5** Scanning Label in a Horizontal Orientation

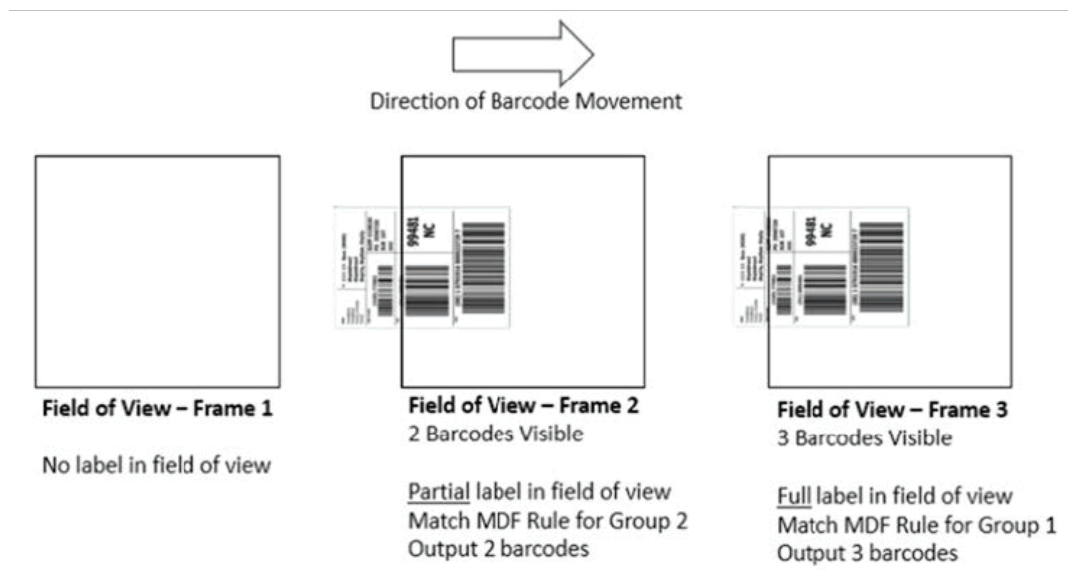

## MDF for Best Practices

Suggestions to minimize the undesired multiple outputs when scanning with MDF.

- Scan barcodes in a vertical orientation.

**Figure 6** Scanning Label in a Vertical Orientation

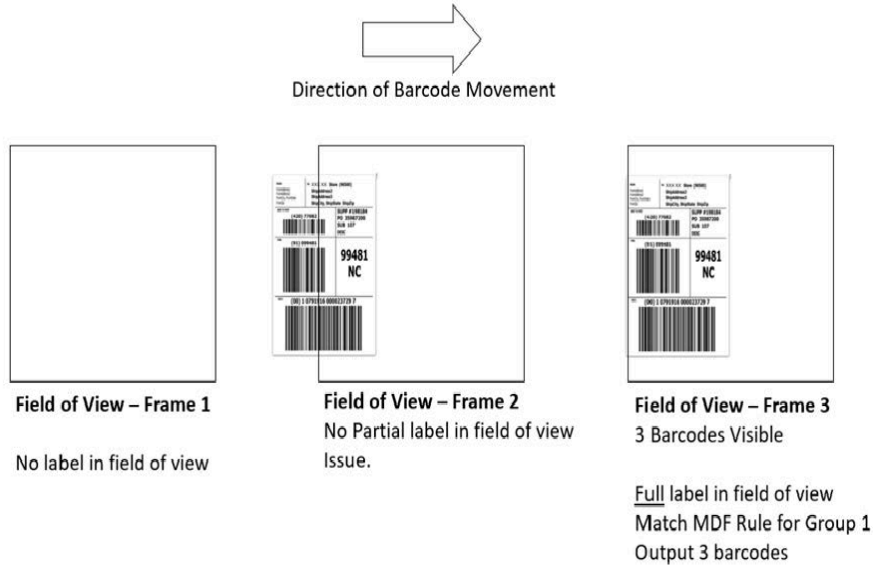

- When creating the MDF programming with multiple groups, the Group 1's pattern match should be the most complicated (hardest to match), which equals to the most number of barcodes and criteria. Then Group 2, 3, and so on should be progressively matched more easily.
- When defining criteria, avoid enabling an output when the pattern is not matched. Set **Output if NO pattern match** set as **Discard barcode**.

**Figure 7** Figure Match Setting for Output

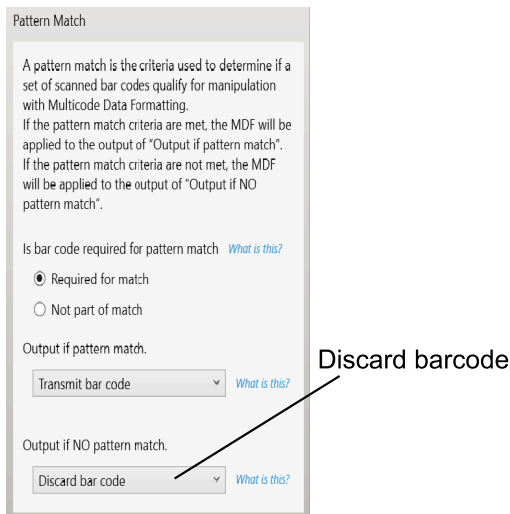

- Select **Discard barcode(s) NOT within the pattern match** in the 123Scan MDF setting. For more details, select **What is this?** located next to this selection.

- To prevent double decodes of the same symbol, increase the **Timeout Between Same Symbols** setting. See [Timeout Between Decodes, Same Symbol](#) for more details.
- Other reasons a label/barcode may not be decoded while in the field of view are as follows:
  - The label out of focus (too close or too far away).
  - Specular reflection (reflection off a shiny surface).
  - The label is presented at an extreme angle to the scanner.

## Preferred Symbol

Preferred Symbol is a barcode prioritization technique that enables favored decoding of high-priority barcode(s). The Preferred Symbol is the only barcode that is decoded and output within the preset Preferred Symbol Timeout. During this time, the scanner attempts to decode the prioritized barcode and reports only this barcode.

For more information, refer to the Multicode Data Formatting and Preferred Symbol User Guide, p/n MN-002895-xx.

To program Preferred Symbol via 123Scan, select **123Scan > Configuration Wizard > Symbologies** screen, and then select **Preferred Symbol** from the drop-down menu. Preferred Symbol programming is saved in the 123Scan configuration file.

**Figure 8** Preferred Symbol Programming Options

Preferred Symbol

Preferred Symbol [What is this?](#)

Options

**Prioritized symbologies**

Preferred Symbol Options  [Edit](#)

**Identify exact bar code**

Preferred symbol criteria [View / Edit](#)

Prioritization time (ms)  [What is this?](#)

# Data Capture

This section provides general instructions for scanning, and the scanner's beeper and LED definitions. Scanning a barcode and attempting to decode its data is known as a **decode session**.

## Scanning

For optimal scanning performance, ensure the surface covered by the active scan area is free of designs (for example, stripes or patterns). Ideally, the area should be a light, solid color.

The scanner uses an object detection wakeup system that provides a high swipe speed and reduces power consumption. The system includes an infrared mode with two power modes: Idle mode, which utilizes infrared LEDs not visible to the human eye, and Full Illumination Mode. Presenting an object to the scanner activates full illumination and removing the object returns the scanner to Idle Mode.

The scanner also has a traditional LED detection wakeup system. The red illumination has two power level modes behave the same way the the IR system does, but use traditional LEDs for both Idle and Full Illumination Mode.

When the object presented in the Field of View (FOV) includes a barcode, the scanner scans the barcode, and if the barcode is successfully decoded, the illumination LEDs return to Idle Mode when the object is removed.

## Active Scan Area

The active scan area is the area in front of the scanner window opening in which a barcode can be decoded, represented by the dotted area.

To scan a barcode, ensure all cable connections are secure, and present the item anywhere within the active scan area with the barcode facing the scanner window.

Figure 9 SM20 Active Scan Area

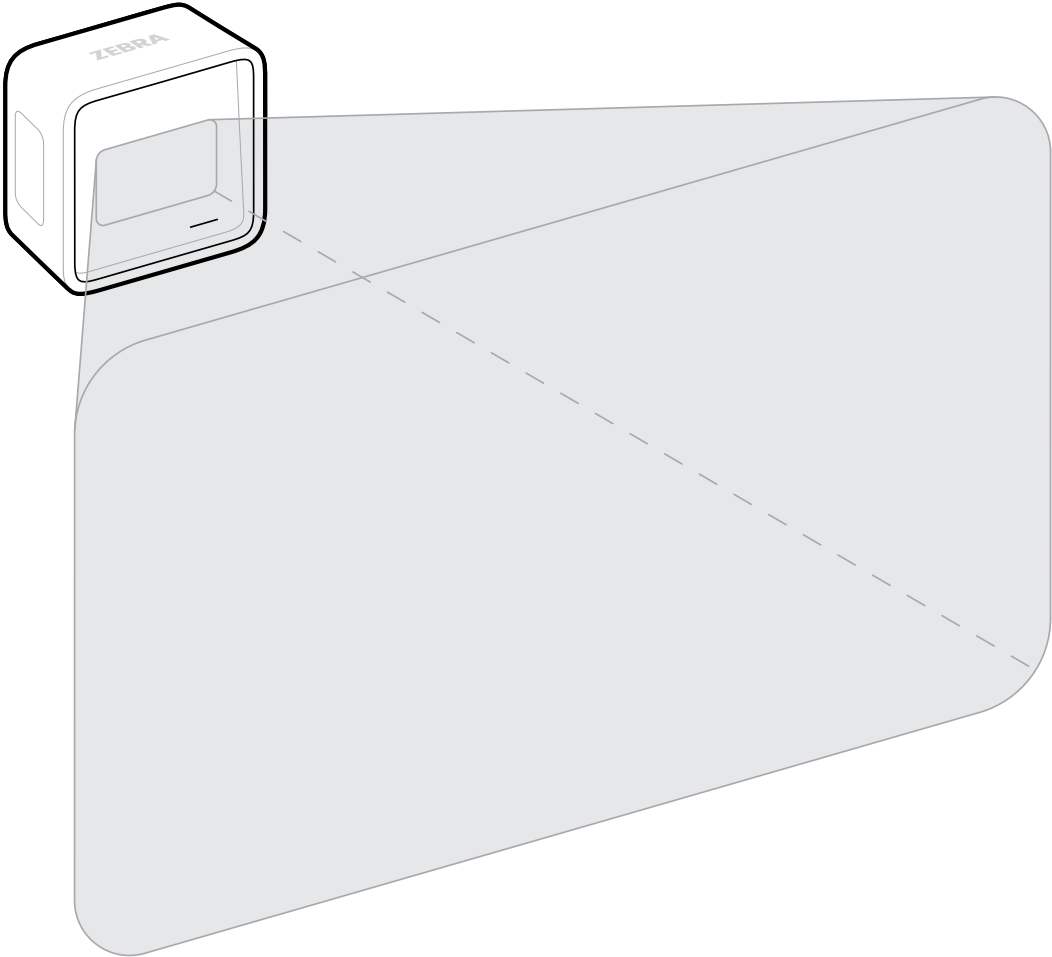

The nominal dimensions of the scan area at the face of the scanner are 52.8 mm (2.08 in.) x 33 mm (1.3 in.).

### Beeper and LED Indicators

In addition to beep sequences, the scanner includes an array of two bi-color (green/red) LEDs to display system status and alerts.

The following table defines beep sequences that occur during scanner operation and programming, and LED indications that display during scanning.

Table 3 Scanner Beeper and LED Indications

Beeper Sequence	LED	Indication
<b>Standard Use</b>		
Low, medium, high	Green	Power up
User-configured	Green (blink off)	A barcode was decoded
None	Center green LED remains ON	Presentation mode is on

**Table 3** Scanner Beeper and LED Indications (Continued)

Beeper Sequence	LED	Indication
4 low	Red	Transmission error
5 low	Red	Conversion or format error
High, High, Low	Red	RS-232 receive error
High	None	A <BEL> character is received over RS-232
None	Red Blinking	Scanner is disabled
<b>Image Capture</b>		
Low	All green, blinking	Snapshot mode started
Low	Green (default) LED mode	Snapshot mode complete
High, low	Green (default) LED mode	Snapshot mode time-out
<b>Parameter Programming</b>		
Low, high	Red	Input error: incorrect bar code, programming sequence, or Cancel scanned
High, low	Green	Number expected; enter value using numeric bar codes
High, low, high, low	Green	Successful program exit with a change in parameter setting
<b>ADF Programming</b>		
High, Low	Green	Number expected, enter another digit. Add leading zeros to the front if necessary.
Low, Low	Green	Alphanumeric expected, enter another alphanumeric character or scan the End of Message barcode
High, High	Green blinking	ADF criteria or action is expected, enter another criteria or action or scan the Save Rule barcode
High, Low, Low	Green	All criteria or actions cleared for current rule, continue entering rule
High, Low, High, Low	Green (turns off after blinking)	Rule saved. Rule entry mode exited.
Low, High	Red	Rule error. Entry error, wrong barcode scanned, or criteria/action list is too long for a rule. Re-enter criteria or action.
Low	Green	Deleted last saved rule. The current rule is left intact.
Low/high/high	Green	All rules deleted
Low, High, Low, High	Red	Out of rule memory. Erase some existing rules, then try to save rule again.
Low, High, Low	Green (turns off after blinking)	Cancel rule entry. Rule entry mode exited because of an error or the user asked to exit rule entry.

**Table 3** Scanner Beeper and LED Indications (Continued)

Beeper Sequence	LED	Indication
<b>Macro PDF</b>		
2 Low	None	Buffered File ID error. A barcode not in the current MPDF sequence was scanned.
2 Long Low	None	File ID error. A barcode not in the current MPDF sequence was scanned.
3 Long Low	None	Out of memory. There is not enough buffer space to store the current MPDF symbol.
4 Long Low	None	Bad symbology. Scanned a 1D or 2D barcode in an MPDF sequence, a duplicate MPDF label, a label in an incorrect order, or trying to transmit an empty or illegal MPDF field.
5 long low	None	Flushing MPDF buffer
Fast Warble	None	Aborting MPDF sequence
Low, High	None	Flushing an already empty MPDF buffer
<b>LED Indicators</b>		
None	Slow Blinking Green	Scanner connected to 123Scan
None	Fast Blinking Red	File being transferred to the scanner (parameters and firmware)
None	Slow Blinking Red	Firmware being activated on the scanner, loaded into memory
None	Solid Green	Programming completed successfully (parameters and firmware)
None	Solid Red	Error State

# Maintenance and Troubleshooting

This section provides suggested maintenance and troubleshooting instructions.

## Maintenance

Suggested maintenance and cleaning tips for your device.

## Known Harmful Ingredients

This section lists substances that should be prevented from coming into contact with the device.

- Acetone
- Ammonia solutions
- Aqueous or alcoholic alkaline solutions
- Aromatic and chlorinated hydrocarbons
- Benzene
- Carboic acid
- Compounds of amines or ammonia
- Ethanolamine
- Ethers
- Ketones
- TB-lysoform
- Toluene
- Trichloroethylene

## Approved Cleaners

- Isopropyl alcohol 70% (including pre-moistened wipes).

## Cleaning the Scanner

Routinely cleaning the scan window is required. A dirty window may affect scanning accuracy. Do not allow any abrasive material to touch the window.

- Dampen a soft cloth with one of the approved cleaning agents listed above or use pre-moistened wipes.
- Gently wipe all surfaces, including the front, back, sides, top, and bottom. Never apply liquid directly to the scanner. Be careful not to let liquid pool around the scan window, cable connectors, or any other area on the device.
- Do not spray water or other cleaning liquids directly onto the scan window.
- Wipe the scan window with a lens tissue or other material suitable for cleaning optical material, such as eyeglasses.
- Immediately dry the scan window after cleaning to prevent streaking.
- Allow the unit to air dry before use.
- Scanner Connectors
  - a) Dip the cotton portion of a cotton-tipped applicator in isopropyl alcohol.
  - b) Rub the cotton portion of the cotton-tipped applicator back and forth across the connectors at least three times, leaving no cotton residue on them.
  - c) Use the cotton-tipped applicator dipped in alcohol to remove grease and dirt near the connector area.
  - d) Use a dry cotton-tipped applicator and rub the cotton portion of the cotton-tipped applicator back and forth across the connectors at least three times. Do not leave any cotton residue on the connectors.

## Troubleshooting



**NOTE:** If you still experience problems after following the instructions in the table, contact the distributor or call support.

**Table 4** Troubleshooting

Problem	Possible Cause	Possible Solution
Indicator bars do not illuminate when a barcode is presented.	No power to the scanner.	If the configuration requires a power supply, reconnect the power supply.
	Incorrect host interface cable is used.	Connect the correct host interface cable.
	Interface/power cables are loose.	Reconnect cables.
	Scanner is disabled.	For IBM 468x and USB IBM hand-held, IBM table-top, and OPOS modes, enable the scanner via the host interface. Otherwise, see the technical person in charge of scanning.
	If using RS-232 Nixdorf B mode, CTS is not asserted.	Assert CTS line.

**Table 4** Troubleshooting (Continued)

Problem	Possible Cause	Possible Solution
Indicator bars illuminate but barcodes do not decode.	The scanner is not programmed for the correct barcode type.	Program the scanner to read that type of barcode. See <a href="#">Symbologies</a> .
	Barcode symbol is unreadable.	Scan test symbols of the same barcode type to determine if the barcode is defaced.
	The symbol is not completely inside illumination.	Move the symbol completely within the illumination. Move the symbol completely within the field of view.
	Distance between SP20 and barcode is incorrect.	Move the scanner closer to or further from the barcode. See <a href="#">Decode Ranges</a> .
The scanner decodes barcode, but does not transmit the data to the host.	The scanner is not programmed for the correct host type.	Scan the appropriate host type programming barcode. Go to the section corresponding to the relevant host type.
	Interface cable is loose.	Re-connect the cable.
	If the beeper emits four long low beeps, a transmission error occurred. This occurs if a unit is not properly configured or connected to the wrong host type.	Set the communication parameters to match the host's setting.
	If the beeper emits 5 low beeps, a conversion or format error occurred.	Configure the scanner's conversion parameters properly.
Host displays scanned data incorrectly.	The scanner is not programmed to work with the host.	Scan the appropriate host type programming barcode.
		For RS-232, set the scanner's communication parameters to match the host's settings.
		Program the proper editing options (for example, UPC-E to UPC-A Conversion).
The beeper emits short low/short medium/short high beep sequence (power-up beep sequence) more than once.	The USB host may put the scanner in a state where power to the scanner is cycled on and off more than once.	Normal during host reset.
The beeper emits 4 short high beeps during decode attempt.	Scanner has not completed USB initialization.	Wait several seconds and scan again.
The beeper emits low/low/low/extra low beeps when not in use.	RS-232 receive error.	Normal during host reset. Otherwise, set the scanner's RS-232 parity to match the host setting.
The beeper emits low/high beeps during programming.	Input error, incorrect barcode or Cancel barcode was scanned.	Scan the correct numeric barcodes within range for the parameter programmed.

**Table 4** Troubleshooting (Continued)

Problem	Possible Cause	Possible Solution
The beeper emits low/high/low/high beeps during programming.	Out of host parameter storage space.	Scan <a href="#">Default Parameters</a> .
	Out of memory for ADF rules.	Reduce the number of ADF rules or the number of steps in the ADF rules.
	During programming, indicates out of ADF parameter storage space.	Erase all rules and re-program with shorter rules.
The beeper emits low/high/low beeps.	ADF transmit error.	Refer to the Advanced Data Formatting Guide for information.
	Invalid ADF rule is detected.	Refer to the Advanced Data Formatting Guide for information.
The beeper emits a power-up beep after changing USB host type.	The USB bus re-established power to the scanner.	Normal when changing USB host type.
The beeper emits one high beep when not in use.	In RS-232 mode, a <BEL> character was received and Beep on <BEL> option is enabled.	Normal when Beep on <BEL> is enabled and the scanner is in RS-232 mode.
The beeper emits frequent beeps.	Inadequate power supplied to the scanner.	Check the system power. If the configuration requires a power supply, re-connect the power supply.
	Incorrect host interface cable is used.	Verify that the correct host interface cable is used. If not, connect the correct host interface cable.
	Interface/power cables are loose.	Check for loose cable connections and re-connect cables.
The beeper emits five long low beeps after a barcode is decoded.	Conversion or format error was detected. The scanner conversion parameters are not properly configured.	Ensure the scanner conversion parameters are properly configured.
	Conversion or format error was detected. An ADF rule was set up with characters that cannot be sent for the host selected.	Change the ADF rule, or change to a host that can support the ADF rule.
	Conversion or format error was detected. A barcode was scanned with characters that cannot be sent for that host.	Scan a different barcode, or change to a host that can support the barcode.
The beeper emits a high, low beeper sequence.	An unsupported USB device was plugged into the USB host port, and/or the device failed enumeration.	Disconnect the unsupported device.

## Dump Scanner Parameters

To debug a scanner issue, scan the following barcode with the scanner connected in USB HID keyboard mode to Microsoft® Windows Notepad or Wordpad or via RS-232 to Windows HyperTerminal. This outputs all the scanner's asset tracking information and parameter settings to a text document.

Refer to the parameter numbers to interpret the parameter/attribute numbers in the output.



**NOTE:** Use 123Scan if available as an alternative to using this feature. 123Scan is the preferred method for outputting scanner information.



**NOTE:** For proper formatting, it may be necessary to first scan [<DATA> <SUFFIX 1> \(1\)](#) under [Scan Data Transmission Format](#)

To select the timeout between decodes for the same symbol, scan the following barcode and then scan two barcodes from [Numeric Barcodes](#) that correspond to the desired interval in 0.1-second increments.



# Specifications

This section provides information regarding the scanner's electrical interfaces, technical specifications, and decode ranges.

Go to [zebra.com/sp20series](http://zebra.com/sp20series) for the scanner's technical specifications page.

## Electrical Interface

**Table 5** SP20 - USB and Serial Electrical Interface

Pin No.	Name	Description
1	Cable ID	Cable detection input.
2	5 V DC	USB 5 V DC signal. This is an input to indicate that the system is connected to a host. Input power is 5 V DC +/- 5%, 500 mA max.
3	GND	Power supply ground input and signal ground reference.
4	RS-232 TXD	Serial Mode: Serial data transmit output. It drives the serial data receive input on the host device.
5	USB D+ RS-232 RXD and RS-232 TXD (Host)	USB: D+ Signal, 1/2 of differential pair for USB Communication. Serial Mode: Serial data receive input. It is driven by the serial data transmit output on the host device and Serial Mode: Data transmitted from the host.
6	RS-232 RTS	Serial Mode: Request-to-send handshaking output line. It may be optionally used by the scanner to signal to the host device that data is available to send. It can only be utilized in conjunction with the host CTS line.
7	USB D- RS-232 CTS and RS-232 RTS (Host)	USB: D- Signal, 1/2 of differential pair for USB communication. Serial Mode: Clear-to-send handshaking input line. It may be optionally used by the host device to signal the scanner that it may commence transmitting data. It can be used only in conjunction with the host RTS line.
8	DOWNLOAD	This signal is used to begin the Flash Download operation when asserted high.
9	NC	No connection.
10	NC	No connection.

## Typical Decode Ranges

**Table 6** Presentation Mode

Type	Range (cm)	Range (in)
Code 39 3 mil	1.78–3.35	0.7–2.5
Code 39 5 mil	0–13.97	0–5.5
Code 39 20 mil	0–40.64	0–16
Code 128 3 mil	1.78–58.4	0.7–2.3
Code 128 5 mil	0–12.7	0–5
PDF 6.7 mil	0–11.43	0–4.5
100% UPC	0–25.4	0–10
Dot Matrix 1 10 mil	0–12.7	0–5
QR Code 20 mil	0–19.81	0–7.8

# USB Interface

This section describes how to set up the scanner with a USB host. The scanner connects directly to a USB host, or a powered USB hub, which powers it. The scanner ships with the settings shown in [USB Parameter Defaults](#). If the default values suit requirements, programming is not necessary.

## USB Parameter Defaults

**Table 7** USB Interface Parameter Defaults

Parameter	Default
USB Device Type	USB HID Keyboard
Ignore Unknown Characters	Send Barcodes With Unknown Characters
Product ID (PID) Type	Host Mode Unique
Product ID (PID) Value	0
EC Level	0
TGCS (IBM) USB Beep Directive	Ignore
TGCS (IBM) USB Barcode Configuration Directive	Ignore
IBM Scanner Generic Management Information	Disable
IBM Scanner Vendor Specific Management Information	Disable
USB Convert Unknown to Code 39	Disable
USB IBM Long Direct I/O	Disable
TGCS (IBM) USB Specification Version	Version 2.2
TGCS (IBM) USB Direct I/O Beep	Honor
IBM Flash Update	Disable
USB Keystroke Delay	No Delay
USB Caps Lock Override	Do Not Override Caps Lock Key (Disable)
Keypad Emulation	Enable
Keypad Emulation with Leading Zero	Enable
Function Key Mapping	Disable

**Table 7** USB Interface Parameter Defaults (Continued)

Parameter	Default
Convert Case	No Case Conversion
USB Keyboard FN1 Substitution	Disable
USB Polling Interval	3 msec
Quick Keypad Emulation	Enable
USB Fast HID	Enable
SNAPI Status Handshaking	Enable
Beep on BEL	Enable
USB CDC Host Variant	Standard USB CDC
USB Static CDC	Enable

## USB Device Type

This parameter defines the type of USB device the scanner communicates with.

To select a country keyboard type for the USB HID Keyboard host, see [Country Codes](#).

- When changing USB device types, the scanner resets and issues the standard startup beep sequences.
- When connecting two scanners to a host, IBM does not allow selecting two of the same device type. If you require two connections, select an IBM Table-top USB for one scanner and an IBM Hand-held USB for the second scanner.
- Select OPOS (IBM Hand-held with Full Disable) to completely shut off the scanner when an IBM register issues a Scan Disable command, including aim, illumination, decoding, and data transmission.
- Before selecting USB CDC Host, ensure your host OS has a USB CDC driver installed. For reference, Windows 11 includes a native (built-in) USB CDC driver. To recover a scanner stalled (non-functional) in USB CDC mode:
  - Install a USB CDC Driver
  - For USB CDC Host, send the following two-byte sequences to the decoder. ESC is ASCII 27.
    - Temporarily switch to SSI Over USB CDC: ESC s (lower case s or ASCII 115)
    - Permanently switch to SSI Over USB CDC: ESC S (upper case S or ASCII 83)
    - Temporarily switch to SNAPI: ESC a (lowercase a or ASCII 97).
    - Permanently switch to SNAPI: ESC A (upper case A or ASCII 65)
- Select USB HID POS to communicate over a USB cable with Microsoft’s Universal Windows Platform (UWP) applications running on Windows 11 devices.



\*USB HID Keyboard



IBM Table-top USB



IBM Hand-held USB



OPOS (IBM Hand-held with Full Disable)



USB CDC Host

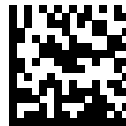

SSI over USB CDC



Symbol Native API (SNAPI) without Imaging Interface



Symbol Native API (SNAPI) with Imaging Interface



USB HID POS (Windows 10/11 devices only)

## USB Barcodes with Unknown Characters

This option applies only to the USB HID Keyboard and IBM devices. Unknown characters are characters the host does not recognize. Select Send Barcodes With Unknown Characters to send all barcode data except for unknown characters. The scanner issues no error beeps.

Select Do Not Send Barcodes With Unknown Characters for IBM devices to prevent sending barcodes containing at least one unknown character to the host, or for USB HID Keyboard devices to send the barcode characters up to the unknown character. The scanner issues an error beep.



\*Send Barcodes with Unknown Characters



Do Not Send Barcodes with Unknown Characters

## Product ID (PID) Type

### Parameter # 1281 (SSI # F8h 05h 01h)

This parameter defines the PID value reported in USB enumeration.



\*Host Type Unique (0)



Product Unique (1)



IBM Unique (2)

## Product ID (PID) Value

### Parameter # 1725 (SSI # F8h 06h BDh)

This parameter sets a Product ID (PID) value.



**NOTE:** This parameter applies to customers using a Firmware Flash Update per the Toshiba Global Commerce Solutions (TGCS) Universal Serial Bus OEM Point-of-Sale Device Interface.

To set a Product ID value, scan **Set PID Value**, and then scan four numeric barcodes in [Numeric Barcodes](#) that correspond to the value. Enter a leading zero for single-digit numbers. To correct an error, or change a selection, scan [Cancel](#). The range is (0 - 1649). The default is 0.



Set PID Value

## ECLevel

### Parameter # 1710 (SSI # F8h 06h AEh)

This parameter sets an ECLevel.



**NOTE:** This parameter applies to customers using a Firmware Flash Update per the Toshiba Global Commerce Solutions (TGCS) Universal Serial Bus OEM Point-of-Sale Device Interface. It allows defining an ECLevel value to manage and control Flash Update operations on the 4690 operating system.

Contact Zebra Support at [zebra.com/support](http://zebra.com/support) for more information.

To set an ECLevel value, scan **Set ECLevel**, and then scan five numeric barcodes in [Numeric Barcodes](#) that correspond to the desired level. Enter a leading zero for single digit numbers. To correct an error, or change a selection, scan [Cancel](#).



Set ECLevel

## TGCS (IBM) USB Beep Directive

The host can send a beeper configuration request to the scanner. Scan Ignore Beep Directive to prevent the scanner from processing the host request. All directives are still acknowledged to the USB host as if they were processed.



Honor Beep Directive

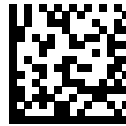

\*Ignore Beep Directive

## TGCS (IBM) USB Barcode Configuration Directive

The host can enable and disable code types. Scan Ignore Barcode Configuration Directive to prevent the scanner from processing the host request. All directives are still acknowledged to the USB host as if they were processed.



Honor Barcode Configuration Directive



\*Ignore Barcode Configuration Directive

## IBM Scanner Generic Management Information

### Parameter # 1940

Enable this to return generic scanner management information.



Enable IBM Scanner Generic Management Information (1)



\*Disable IBM Scanner Generic Management Information (0)

## IBM Scanner Vendor Specific Management Information

### Parameter # 1941

Enable this to return contests and format information determined by the scanner/scale manufacturer.



Enable IBM Scanner Vendor Specific Management Information (1)

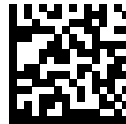

\*Disable IBM Scanner Vendor Specific Management Information (0)

## TGCS (IBM) USB Direct I/O Beep

### Parameter # 1360

The host can send a direct I/O beep request to the scanner. If you select Ignore Direct I/O Beep, the scanner does not beep when it receives this command. All directives are still acknowledged to the USB host as if they were processed.



\*Honor Direct I/O Beep



Ignore Direct I/O Beep

## USB Convert Unknown to Code 39

This option applies only to the IBM hand-held, IBM table-top, and OPOS devices. Select an option to enable or disable converting unknown barcode type data to Code 39.



Enable Convert Unknown to Code 39



\*Disable Convert Unknown to Code 39

## TGCS (IBM) USB Specification Version

### Parameter # 45026

You can specify code types as unknown or with an appropriate IBM identifier.

Select IBM Specification Level (Original) to send the following code types as Unknown:

- Data Matrix
- GS1 Data Matrix
- QR Code
- GS1 QR
- MicroQR Code
- Aztec

Select IBM Specification Level Version 2.2 to send the code types with the appropriate IBM identifiers.



IBM Specification Level (Original)



\*IBM Specification Level Version 2.2 or higher

## USB IBM Long Direct I/O

### Parameter # 1147

Use this option to enable or disable USB IBM Long Direct I/O.



\*Disable (0)



Enable (1)

## IBM Flash Update

### Parameter # 1727

This parameter enables and disables IBM Flash update.



Enable IBM Flash Update (1)



\*Disable IBM Flash Update (0)

## USB Keystroke Delay

This parameter sets the delay, in milliseconds, between emulated keystrokes. Select a longer delay for hosts that require slower data transmission.



\*No Delay

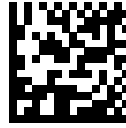

Medium Delay (20 msec)



Long Delay (40 msec)

## USB Caps Lock Override

This option applies only to the USB HID Keyboard device. Select Override Caps Lock Key to preserve the case of the data regardless of the state of the Caps Lock key. This setting is always enabled for the Japanese Windows (ASCII) keyboard type and cannot be disabled.



Override Caps Lock Key (Enable)



\*Do Not Override Caps Lock Key (Disable)

## Keypad Emulation

Select Enable Keypad Emulation to send all characters as ASCII sequences over the numeric keypad. For example, ASCII A transmits as ALT make 0 6 5 ALT Break.



**NOTE:** If your keyboard type is not listed in the country code list (see [Country Codes](#)), disable [Quick Keypad Emulation](#) and enable Keypad Emulation.



\*Enable Keypad Emulation



Disable Keypad Emulation

## Keypad Emulation with Leading Zero

Select Enable Keypad Emulation with Leading Zero to send character sequences sent over the numeric keypad as ISO characters which have a leading zero. For example, ASCII A transmits as “ALT MAKE” 0 0 6 5 “ALT BREAK”.



**NOTE:** This parameter only applies if [Emulate Keypad](#) is enabled.



\*Enable Keypad Emulation with Leading Zero



Disable Keypad Emulation with Leading Zero

## USB Function Key Mapping

ASCII values under 32 are normally sent as a control-key sequence. Select **Enable Function Key Mapping** to send the keys in bold instead of the standard key mapping. Table entries that do not have a bold equivalent remain the same regardless of whether you enable this parameter.



**NOTE:** See [ASCII Character Sets](#) for the ASCII character set information.



Enable Function Key Mapping



\*Disable Function Key Mapping

## USB Simulated Caps Lock

Select Enable Simulated Caps Lock to invert upper and lower case characters on the barcode as if the Caps Lock state is enabled on the keyboard. This inversion occurs regardless of the keyboard's Caps Lock state.



**NOTE:** Simulated Caps Lock applies to ASCII characters only. Do not enable this if [Caps Lock Override](#) is enabled.



Enable Simulated Caps Lock



\*Disable Simulated Caps Lock

## USB Convert Case

Use this parameter to convert all of the barcode data to the selected case.



**NOTE:** Convert Case applies to ASCII characters only.



\*No Case Conversion



Convert All to Upper Case



Convert All to Lower Case

## USB Keyboard FN1 Substitution

This option applies code 128 and ISBT 128 to the USB HID Keyboard device. Scan Enable USB Keyboard FN1 Substitution to replace any FN1 character in a GS1 128 barcode with a user-selected Key Category and value.

See [FN1 Substitution Values](#) to set the Key Category and Key Value.



Enable USB Keyboard FN1 Substitution



\*Disable USB Keyboard FN1 Substitution

## USB Polling Interval

Select an option to set the polling interval, which is the rate at which data transmits between the scanner and host computer. A lower number indicates a faster data rate.



**NOTE:** When changing the USB polling interval, the scanner restarts and issues a power-up beep sequence.



**IMPORTANT:** Ensure the host supports the selected data rate.



1 msec

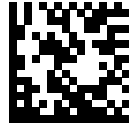

2 msec



\*3 msec



4 msec



5 msec



6 msec



7 msec



8 msec



9 msec



10 msec

## USB Quick Keypad Emulation

Enable Quick Keypad Emulation for a quick method of emulation using the numeric keypad where ASCII sequences are only sent for ASCII characters not found on the keyboard.



**NOTE:** Quick Keypad Emulation only applies to the USB HID Keyboard device when Keypad Emulation is enabled.



\*Enable Quick Keypad Emulation

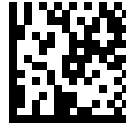

Disable Quick Keypad Emulation

## USB Fast HID

Select Enable USB Fast HID to transmit USB HID data at a faster rate.



**NOTE:** Disable this if there are problems with transmission.

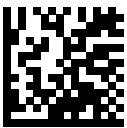

\*Enable USB Fast HID



Disable USB Fast HID

## Symbol Native API (SNAPI) Status Handshaking

After selecting a SNAPI interface as the USB device type, select an option to enable or disable status handshaking.



\*Enable SNAPI Status Handshaking



Disable SNAPI Status Handshaking

## Bluetooth SPP Beep on <BEL>

### Parameter # 150 (SSI # 96h)

This parameter enables the scanner to beep when it detects a <BEL> character on the serial line. <BEL> is issued to alert the user of an illegal entry or other important event.

Choose the following:

- Enabled - Scanner beeps when it detects a <BEL>.
- Disabled - Scanner does not beep when it detects a <BEL>.



**NOTE:** This parameter only applies to SPP (Serial Port Profile), for example, the serial interface on the cradle. In Multipoint-to-Point mode only, the scanner that beeped last sounds Beep on <Bel>.



\*Enable Beep on <BEL> (1)



Disable Beep on <BEL> (0)

## USB CDC Host Variant

### Parameter # 1713

When USB Device Type is set to USB CDC Host, the CDC Host Variant selects which type of CDC variant is used. The default USB CDC host variant is Standard CDC Host Mode.



\*Standard USB CDC (0)



CDC SITA (1)



NCR USB CDC (9)



NCR USB CDC Datalogic (10)

## USB Static CDC

### Parameter # 670

You can connect devices to the same COM port or different COM ports.

When disabled, each device connected consumes another COM port (first device = COM1, second device = COM2, third device = COM3, etc.)

When enabled, each device connects to the same COM port.



\*Enable USB Static CDC (1)



Disable USB Static CDC (0)

# RS-232 Interface

The scanner supports the RS-232 interface to connect to point-of-sale devices, host computers, or other devices with an available RS-232 port (for example, com port).

The scanner ships with the settings shown in [RS-232 Parameter Defaults](#). If the default values suit requirements, programming is not necessary. If your host does not appear in [RS-232 Host-Specific Code ID Characters](#), refer to the documentation for the host device to set communication parameters to match the host.

## RS-232 Host-Specific Code ID Characters

RS-232 hosts have code ID characters that are transmitted automatically.

RS-232 hosts ICL, Fujitsu, Nixdorf Mode A or B, OPOS/JPOS, Olivetti, Omron, CUTE, NCR, or Datalogic transmit code ID characters. These characters are not programmable and are separate from the Transmit Code ID feature. Do not enable the Transmit Code ID feature for these hosts.

**Table 8** RS-232 Host-Specific Code ID Characters

Code Type	ICL	Fujitsu	Wincor-Nixdorf Mode A	Wincor-Nixdorf Mode B/OPOS/JPOS
UPC-A	A	A	A	A
UPC-E	E	E	C	C
EAN-8/JAN-8	FF	FF	B	B
EAN-13/JAN-13	F	F	A	A
Bookland EAN	F	F	A	A
Code 128	L <len>	None	K	K
GS1-128	L <len>	None	P	P
Code 39	C <len>	None	M	M
Code 39 Full ASCII	None	None	M	M
Trioptic	None	None	None	None
Code 32	None	None	None	None
Code 93	None	None	L	L
I 2 of 5	I <len>	None	I	I

**Table 8** RS-232 Host-Specific Code ID Characters (Continued)

Code Type	ICL	Fujitsu	Wincor-Nixdorf Mode A	Wincor-Nixdorf Mode B/OPOS/JPOS
D 2 of 5	H <len>	None	H	H
IATA	H<len>	None	H	H
Codabar	N <len>	None	N	N
MSI	None	None	O	O
GS1 DataBar Variants	None	None	E	E
PDF417	None	None	Q	Q
MicroPDF417	None	None	S	S
Data Matrix	None	None	R	R
GS1 Data Matrix	None	None	W	W
Maxicode	None	None	T	T
QR Code	None	None	U	U
GS1 QR	None	None	X	X
Aztec/Aztec Rune	None	None	V	V

**Table 9** RS-232 Host-Specific Code ID Characters

Code Type	Olivetti	Omron	CUTE	NCR	Datalogic
UPC-A	A	A	A	A	A
UPC-E	C	E	None	E	E
EAN-8/JAN-8	B	FF	None	FF	FF
EAN-13/JAN-13	A	F	A	F	F
Code 128	K <len>	L <len>	5	B3	#
Code 39	M <len>	C <len>	3	B1	*
Code 39 Full ASCII	None	None	3	None	None
Trioptic	None	None	None	None	\$T
I 2 of 5	I <len>	I <len>	1	B2	i
D 2 of 5	H <len>	H <len>	2	None	None
IATA	H<len>	H<len>	2	None	IA
Codabar	N <len>	N <len>	None	N	%
MSI	O <len>	None	None	None	@
GS1 DataBar Variants	None	None	None	je0	DataBar-R4 DataBar Limited: RL DataBar Expanded: RX

## RS-232 Parameter Defaults

**Table 10** Parameter Default Table

Parameter	Parameter Default
RS-232 Host Types	Standard
RS-232 Baud Rate	9600
RS-232 Parity	None
Check Receive Errors	Enable
RS-232 Stop Bits	One stop bit
RS-232 Data Bits	Eight bits
Hardware Handshaking	None
Software Handshaking	None
RS-232 Barcodes with Unknown Characters	Send
RS-232 Host Serial Response Timeout	2 seconds
RTS Line State	Low
Beep on BEL	Disable
Intercharacter Delay	0 msec
Datalogic Host Format	Enable
Datalogic Supported Commands	Disable
Nixdorf Beep/LED Options	Normal operation
<b>NCR</b>	
NCR Prefix	N/A
NCR Use Prefix	Enable
NCR Use Block Check Character (BBC)	Enable
NCR Prefix	1002
NCR Suffix	1003
NCR 2-D Label ID Mode	NCR Mode

### RS-232 Host Types

Select an RS-232 host interface using one of the following options.

Notes on using RS-232 host types:

- For a list of supported scanner functionality by communication protocol, see [Communication Protocol Functionality](#).
- Scanning Standard RS-232 activates the RS-232 driver, but does not change port settings (for example, parity, data bits, handshaking). Selecting another RS-232 host type barcode changes these settings.
- The CUTE host disables all parameter scanning, including Set Defaults. If you inadvertently select CUTE, scan [Enable Parameter Barcode Scanning](#), and then change the host selection.



\*Standard RS-232



ICL RS-232



Nixdorf RS-232 Mode A



Nixdorf RS-232 Mode B



Olivetti ORS4500



Omron



OPOS/JPOS



Fujitsu RS-232



CUTE

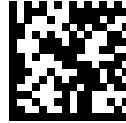

NCR



Datalogic Variant

## RS-232 Baud Rate

The RS-232 baud rate is the number of bits of data transmitted per second.

Select an option to set the scanner's baud rate to match the baud rate setting of the host device. Otherwise, data may not reach the host device or may reach it in distorted form.



\*Baud Rate 9600

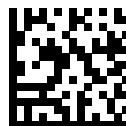

Baud Rate 19,200



Baud Rate 38,400



Baud Rate 57,600



Baud Rate 115,200

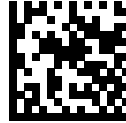

Baud Rate 230,400



Baud Rate 460,800



Baud Rate 921,600

## RS-232 Parity

A parity check bit is the most significant bit of each ASCII coded character. Choose an option to select the parity type according to host device requirements.

- Odd - This sets the parity bit value to 0 or 1, based on data, to ensure that the coded character contains an odd number of 1 bits.
- Even - This sets the parity bit value to 0 or 1, based on data, to ensure that the coded character contains an even number of 1 bits.
- None - No parity bit is required.



Odd



Even



\*None

## Check Receive Errors

This parameter determines whether to check the parity, framing, and overrun of received characters.



**NOTE:** The parity value of received characters is verified against the value set for [Parity](#).



\*Check For Received Errors



Do Not Check For Received Errors

## RS-232 Stop Bits

The stop bit(s) at the end of each transmitted character marks the end of transmission of one character and prepares the receiving device for the next character in the serial data stream. Select an option to set the number of stop bits (one or two) based on the number the receiving host can accommodate.



\*1 Stop Bit

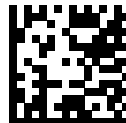

2 Stop Bits

## Data Bits

This parameter allows the scanner to interface with auxiliary scanners requiring a 7-bit or 8-bit ASCII protocol.



7 Data Bits



\*8 Data Bits

## Hardware Handshaking

The data interface consists of an RS-232 port designed to operate either with or without the hardware handshaking lines Request to Send (RTS) and Clear to Send (CTS).

If hardware handshaking and software handshaking are both enabled, hardware handshaking takes precedence.



**NOTE:** The DTR signal is jumpered to the active state.

You can choose one of the following options:

### None

This disables hardware handshaking and transmits scan data as it becomes available.

### Standard RTS/CTS

This sets standard RTS/CTS hardware handshaking and transmits scanned data. The scanner reads the CTS line for activity according to the following sequence:

- If the CTS line is de-asserted, the scanner asserts the RTS line and waits up to [Host Serial Response Timeout](#) for the host to assert CTS, and then transmits data when asserted. If, after the timeout, the CTS line is not asserted, the scanner sounds a transmit error and discards the data.
- If CTS is asserted, the scanner waits up to [Host Serial Response Timeout](#) for the host to de-assert CTS. If after this timeout the CTS line is still asserted, the scanner sounds a transmit error and discards the scanned data.
- The scanner de-asserts RTS after sending the last character of data.
- The host negates CTS. The scanner checks for a de-asserted CTS upon the next data transmission.



**NOTE:** During data transmission, if CTS is deasserted for more than 50 ms between characters, the scanner sounds a transmit error and discards the data. The data must be re-scanned.

### RTS/CTS Option 1

The scanner asserts RTS before transmitting and ignores the state of CTS. The scanner de-asserts RTS when transmission completes.

## RTS/CTS Option 2

RTS is always high or low (user-programmed logic level). However, the scanner waits for the host to assert CTS before transmitting data. If CTS is not asserted within the [Host Serial Response Timeout](#), the scanner sounds a transmit error and discards the data. During data transmission, if CTS is deasserted for more than 50 ms between characters, the scanner sounds a transmit error and discards the data.

## RTS/CTS Option 3

This transmits scanned data according to the following sequence:

- The scanner asserts RTS before data transmission, regardless of the state of CTS.
- The scanner waits up to the [Host Serial Response Timeout](#) for the host to assert CTS, and then transmits data when asserted. If, after the timeout, the CTS line is not asserted, the scanner sounds a transmit error and discards the data.
- The scanner de-asserts RTS after sending the last character of data.
- The host negates CTS. The scanner checks for a de-asserted CTS upon the next data transmission.



**NOTE:** During data transmission, if CTS is deasserted for more than 50 ms between characters, the scanner sounds a transmit error and discards the data. The data must be re-scanned.



\*None

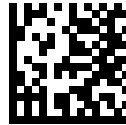

Standard RTS/CTS



RTS/CTS Option 1



RTS/CTS Option 2

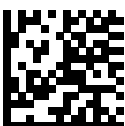

RTS/CTS Option 3

## Software Handshaking

This parameter offers control of data transmission in addition to, or instead of, that offered by hardware handshaking. If software handshaking and hardware handshaking are both enabled, hardware handshaking takes precedence.

- None - This transmits data immediately. The scanner expects no response from the host.
- ACK/NAK - After transmitting data, the scanner waits for an ACK or NAK response from the host. If it receives a NAK, the scanner transmits the data again and waits for an ACK or NAK. After three unsuccessful attempts to send data after receiving NAKs, the scanner sounds a transmit error and discards the data. The scanner waits up to the programmable [Host Serial Response Timeout](#) to receive an ACK or NAK. If the scanner does not get a response in this time, it sounds a transmit error and discards the data. There are no reattempts.
- ENQ - The scanner waits for an ENQ character from the host before transmitting data. If it does not receive an ENQ within the [Host Serial Response Timeout](#), the scanner sounds a transmit error and discards the data. The host must transmit an ENQ character at least every [Host Serial Response Timeout](#) to prevent transmission errors.
- ACK/NAK with ENQ - This combines the two previous options. An additional ENQ is not required to retransmit data due to a NAK from the host.
- XON/XOFF - An XOFF character stops data transmission until the scanner receives an XON character. There are two situations for XON/XOFF:
  - The scanner receives an XOFF before it has data to send. When the scanner has data, it waits up to the [Host Serial Response Timeout](#) for an XON character before transmitting. If it does not receive the XON within this time, the scanner sounds a transmit error and discards the data.
  - The scanner receives an XOFF during data transmission and stops transmission after sending the current byte. When the scanner receives an XON character, it sends the rest of the data. The scanner waits indefinitely for the XON.



\*None



ACK/NAK



ENQ



ACK/NAK with ENQ



XON/XOFF

### RS-232 Barcodes with Unknown Characters

Unknown characters are characters the host does not recognize. Select Send Barcodes With Unknown Characters to send all barcode data except for unknown characters. The scanner issues no error beeps.

Select Do Not Send Barcodes With Unknown Characters to send barcode data up to the first unknown character. The scanner issues an error beep.



\*Send Barcodes With Unknown Characters



Do Not Send Barcodes With Unknown Characters

### RS-232 Host Serial Response Timeout

This parameter specifies how long the scanner waits for an ACK, NAK, or CTS before determining that a transmission error occurred. This only applies when in one of the ACK/NAK software handshaking modes, or RTS/CTS hardware handshaking mode.



\*Minimum: 2 Seconds



Low: 2.5 Seconds



Medium: 5 Seconds

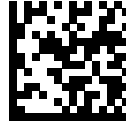

High: 7.5 Seconds



Maximum: 9.9 Seconds

### RTS Line State

This parameter sets the idle state of the serial host RTS line to Low RTS or High RTS.



\*Host: Low RTS



Host: High RTS

### Beep on <BEL>

This parameter sets whether the scanner issues a beep when it detects a <BEL> character on the RS-232 serial line. <BEL> indicates an illegal entry or another important event.



Beep On <BEL> Character (Enable)



\*Do Not Beep On <BEL> Character (Disable)

## Intercharacter Delay

This parameter specifies the intercharacter delay inserted between character transmissions.



\*Minimum: 0 msec

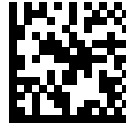

Low: 25 msec



Medium: 50 msec

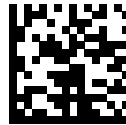

High: 75 msec



Maximum: 99 msec

## Datalogic Host Format

### Parameter # 2253 (SSI # F8 08 CD)

When this parameter is enabled, the Datalogic host variant appends a code ID and a suffix value (CR) to the decoded data. When this parameter is disabled, only the decoded data is transmitted. These commands are supported over RS232 or USB CDC.



\*Enable (1)



Disable (0)

## Datalogic Supported Commands

### Parameter # 2260 (SSI # F8 08 D4)

This parameter allows serial scan to enable or disable commands for a standard RS232 host.

- 'E' or 'e' = Enable Scanning
- 'D' or 'd' = Disable Scanning
- 'R' = Reset the scanner
- 'F' = Indicate to the scanner that Datalogic is not on file
- 'B' = Issue a good read beep
- 1 (Not an ASCII Character – This is a decimal number 1) = Force a good read beep
- 7 (Not an ASCII Character – This is a decimal number 7) = Force a good read beep



Enable (1)



\*Disable (0)

## Nixdorf Beep/LED Options

### Parameter # 45062 SSI = F8h B0h 06h

If you selected Nixdorf Mode B, use this parameter to determine when the scanner beeps and turns on its LED after a decode.



\*Normal Operation (Beep/LED Immediately After Decode)



Beep/LED After Transmission



Beep/LED After CTS Pulse

## NCR Use Prefix

### Parameter # 1238

You can enable or disable NCR using the prefix.

If you selected NCR from [RS-232 Host Types](#), use this parameter to enable or disable using the prefix for all communications.



\*Enable NCR Use Prefix (1)



Disable NCR Use Prefix (0)

## NCR Use Block Check Character (BCC)

### Parameter # 1239

You can enable Block Check Character if you enabled NCR.

If you selected NCR from , use this parameter to enable or disable using the Block Check Character (after the Terminator byte) for all communications.



\*Enable NCR Use BCC (1)

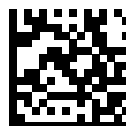

Disable NCR Use BCC (0)

## NCR Prefix

### Parameter # 1282

You can set the prefix character to use if you enabled NCR.

If you selected NCR from and enabled [NCR Use Prefix](#), set the prefix character to use for all communications.

To do this, scan the following barcode, and then scan four numeric barcodes from [Numeric Barcodes](#) that correspond to the desired character in [NCR Use Prefix](#). The default is 1002 (STX).



NCR Prefix

## NCR Suffix

### Parameter # 1283

You can set the suffix (terminator) character to use if you enabled NCR.

If you selected NCR from , set the suffix (terminator) character to use for all communications.

To do this, scan the following barcode, and then scan four numeric barcodes from [Numeric Barcodes](#) that correspond to the desired character in [ASCII Character Sets](#). The default is 1003 (ETX).



NCR Suffix

## NCR 2D Label-ID Mode

### Parameter # 1948

Select an NCR 2D Label-ID mode for the defined bar code prefix type.

- NCR Mode - Adds an NCR prefix to a bar code. This is the default.
- Legacy Mode - Adds an non-NCR prefix to a bar code.
- Suppress Mode - No prefix is added to a bar code.



\* NCR Mode (0)



Legacy Mode (1)



Suppress Mode (2)

# SSI Interface

This section describes the system requirements of the Simple Serial Interface (SSI), which provides a communications link between Zebra decoders (e.g., scan engines, slot scanners, hand-held scanners, two-dimensional scanners, hands-free scanners, and RF base stations) and a serial host. It provides the means for the host to control the decoder or scanner.

## Communication

All communication between the scanner and host occurs over the hardware interface lines using the SSI protocol. Refer to the Simple Serial Interface Programmer's Guide, p/n 72E-40451-xx, for more information on SSI.

The host and the scanner exchange messages in packets. A packet is a collection of bytes framed by the proper SSI protocol formatting bytes. The maximum number of bytes per packet that the SSI protocol allows for any transaction is 257 (255 bytes + 2 byte checksum).

Depending on the configuration, the scanner can send decode data as ASCII data (unpacked), or as part of a larger message (packeted).

SSI performs the following functions for the host device:

- Maintains a bi-directional interface with the scanner
- Allows the host to send commands that control the scanner
- Passes data from the scanner to a host device in SSI packet format or straight decode message.

The SSI environment consists of a scanner, a serial cable which attaches to the host device, and if required, a power supply.

SSI transmits all decode data including special formatting (for example, AIM ID). Parameter settings can control the format of the transmitted data.

The scanner can also send parameter information, product identification information, or event codes to the host.

All commands sent between the scanner and host must use the format described in the SSI Message Formats section. [SSI Transactions](#) describes the required sequence of messages in specific cases.

## SSI Commands

The following table lists all the SSI opcodes the scanner supports. The host transmits opcodes designated type H. The scanner (decoder) transmits type D opcodes and transmits Host/Decoder (H/D) types.

**Table 11** SSI Commands

Name	Type	Opcode	Description
BEEP	H	0xE6	Sound the beeper.
CAPABILITIES_REPLY	D	0xD4	Reply to CAPABILITIES_REQUEST; contains a list of the capabilities and commands the decoder supports.
CAPABILITIES_REQUEST	H	0xD3	Request capabilities report from the decoder.
CMD_ACK	H/D	0xD0	Positive acknowledgment of received packet.
CMD_NAK	H/D	0xD1	Negative acknowledgment of received packet.
DECODE_DATA	D	0xF3	Decode data in SSI packet format.
EVENT	D	0xF6	Event indicated by associated event code.
LED_OFF	H	0xE8	De-activate LED output.
LED_ON	H	0xE7	Activate LED output.
PARAM_DEFAULTS	H	0xC8	Set parameter default values.
PARAM_REQUEST	H	0xC7	Request values of certain parameters.
PARAM_SEND	H/D	0xC6	Send parameter values.
REPLY_REVISION	D	0xA4	Reply to REQUEST_REVISION, contains the decoder's software/hardware configuration.
REQUEST_REVISION	H	0xA3	Request the decoder's configuration.
SCAN_DISABLE	H	0xEA	Prevent the operator from scanning barcodes.
SCAN_ENABLE	H	0xE9	Permit barcode scanning.
SLEEP	H	0xEB	Request to place the decoder into low power.
START_DECODE	H	0xE4	Tell the decoder to attempt to decode a barcode.
STOP_DECODE	H	0xE5	Tell the decoder to abort a decode attempt.
WAKEUP	H	N/A	Wake the decoder from low power mode.

For details of the SSI protocol, refer to the Simple Serial Interface Programmer's Guide.

## SSI Transactions

### General Data Transactions

This section describes general data transactions between the scanner and a host.

#### ACK/NAK Handshaking

If you enable ACK/NAK handshaking (the default), all packeted messages must have a CMD\_ACK or CMD\_NAK response, unless the command description states otherwise. Zebra recommends leaving this handshaking enabled to provide feedback to the host. Raw decode data and WAKEUP do not use ACK/NAK handshaking since they are not packeted data.

Following is an example of a problem which can occur if you disable ACK/NAK handshaking:

- The host sends a PARAM\_SEND message to the scanner to change the baud rate from 9600 to 19200.
- The scanner cannot interpret the message.
- The scanner does not implement the change the host requested.
- The host assumes that the parameter change occurred and acts accordingly.
- Communication is lost because the change did not occur on both sides.

If you enable ACK/NAK handshaking, the following occurs:

- The host sends a PARAM\_SEND message.
- The scanner cannot interpret the message.
- The scanner CMD\_NAKs the message.
- The host resends the message.
- The scanner receives the message successfully, responds with CMD\_ACK, and implements parameter changes.

## Decoded Data Transmission

The [Decode Data Packet Format](#) parameter controls how decode data is sent to the host. Set this parameter to send the data in a DECODE\_DATA packet. Clear this parameter to transmit the data as raw ASCII data.



**NOTE:** When transmitting decode data as raw ASCII data, ACK/NAK handshaking does not apply regardless of the state of the ACK/NAK handshaking parameter.

### ACK/NAK Enabled and Packeted Data

The scanner sends a DECODE\_DATA message after a successful decode. The scanner waits for a programmable timeout for a CMD\_ACK response. If it does not receive the response, the scanner tries to send two more times before issuing a host transmission error. If the scanner receives a CMD\_NAK from the host, it may attempt a retry depending on the cause field of the CMD\_NAK message.

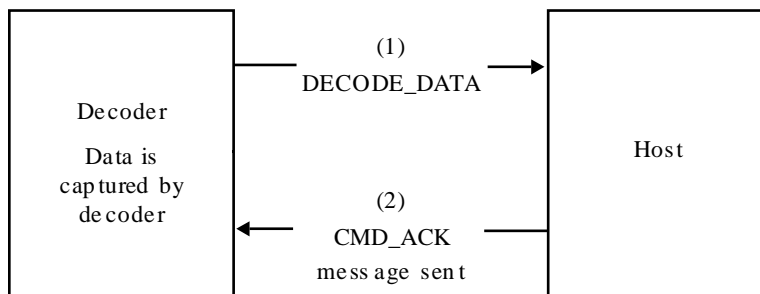

### ACK/NAK Enabled and Unpacketed ASCII Data

Even if ACK/NAK handshaking is enabled, no handshaking occurs because handshaking applies only to packeted data. In this example the packeted\_decode parameter is disabled.

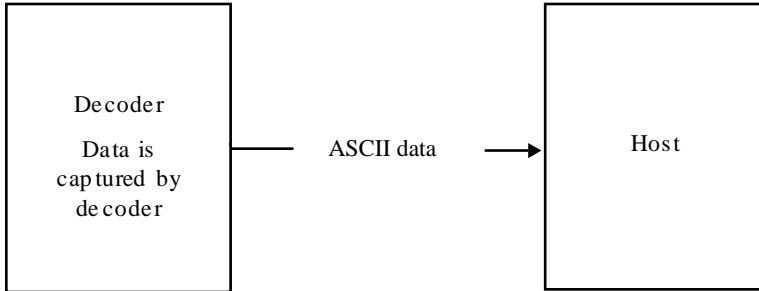

## ACK/NAK Disabled and Packeted DECODE\_DATA

In this example ACK/NAK does not occur even though packeted\_decode is enabled because the ACK/NAK handshaking parameter is disabled.

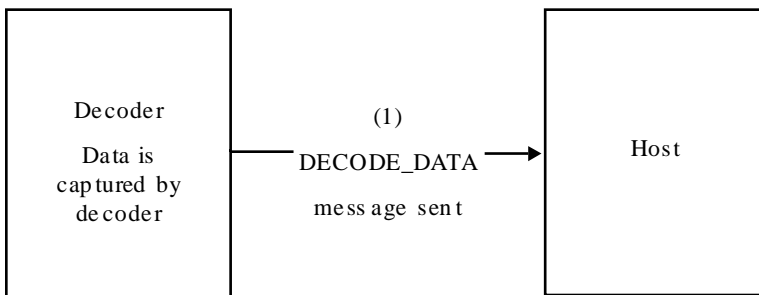

## ACK/NAK Disabled and Unpacketed ASCII Data

The decoder sends captured data to the host.

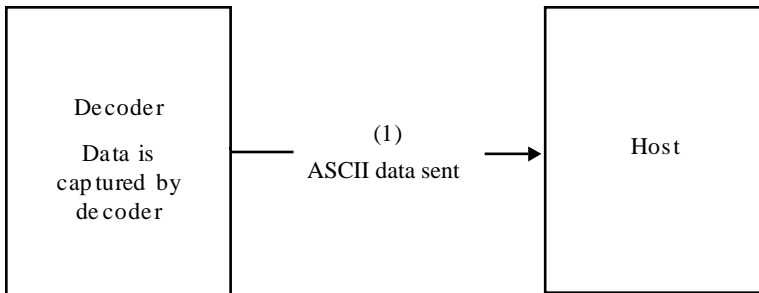

## Communication Summary

### RTS/CTS Lines

All communication must use RTS/CTS handshaking as described in the Simple Serial Interface Programmer's Guide, p/n 72E-40451-xx. If bypassing hardware handshaking, the host must send the WAKEUP command before all other communication or the first byte of a message can be lost during the scanner wakeup sequence. Zebra recommends not bypassing RTS/CTS hardware handshaking.

## ACK/NAK Option

ACK/NAK handshaking is enabled by default and Zebra recommends leaving it enabled. Disabling this can cause communication problems, as handshaking is the only acknowledgment that a message was received correctly. ACK/NAK is not used with unpacketed decode data regardless of whether it is enabled.

## Number of Data Bits

All communication with the scanner must use 8-bit data.

## Serial Response Timeout

The [Host Serial Response Timeout](#) parameter determines how long to wait for a handshaking response before trying again or aborting further attempts. Set the same value for both the host and scanner.



**NOTE:** You can temporarily change the [Host Serial Response Timeout](#) when the host takes longer to process an ACK or longer data string. Zebra does not recommend frequent permanent changes due to limited write cycles of non-volatile memory.

## Retries

The host resends data twice after the initial send if the scanner does not respond with an ACK or NAK (if ACK/NAK handshaking is enabled), or response data (for example, PARAM\_SEND, REPLY\_REVISION). If the scanner replies with a NAK RESEND, the host resends the data. All resent messages must have the resend bit set in the Status byte.

The scanner resends data two times after the initial send if the host fails to reply with an ACK or NAK (if ACK/NAK handshaking is enabled).

## Baud Rate, Stop Bits, Parity, Response Timeout, ACK/NAK Handshaking

If you use PARAM\_SEND to change these serial parameters, the ACK response to the PARAM\_SEND uses the previous values for these parameters. The new values then take effect for the next transaction.

## Errors

When the scanner encounters a communication error, it emits an error beep.

The scanner issues a communication error when:

- The CTS line is asserted when the scanner tries to transmit, and is still asserted on each of two successive retries
- The scanner does not receive an ACK or NAK after initial transmit and two resends.

## SSI Communication Notes

Follow these best practices for SSI communication.

- When not using hardware handshaking, space messages sufficiently apart. The host must not communicate with the scanner if the scanner is transmitting.
- When using hardware handshaking, frame each message properly with handshaking signals. Do not try to send two commands within the same handshaking frame.

- There is a permanent/temporary bit in the PARAM\_SEND message. Removing power from the scanner discards temporary changes. Permanent changes are written to non-volatile memory. Frequent changes shorten the life of the non-volatile memory.

## Encapsulation of RSM Commands/Responses over SSI

The SSI protocol allows the host to send a command that is variable in length up to 255 bytes. Although there is a provision in the protocol to multi-packet commands from the host, the scanner does not support this. The host must fragment packets using the provisions in the RSM protocol.

### Command Structure

Byte	7	6	5	4	3	2	1	0
0	Length (not including the checksum)							
1	SSI_MGMT_COMMAND (0x80)							
2	Message Source (4 - Host)							
3	Reserved (0)			Reserved (0)		Reserved (0)	Cont'd packet	Retransmit
4	Payload data (see the following example)							
...								
Length -1								
Length	2's complement checksum (MSB)							
Length +1	2's complement checksum (LSB)							

The expected positive response is SSI\_MGMT\_COMMAND which can be a multi-packet response. Devices that do not support this command respond with the standard SSI\_NAK.

### Response Structure

Byte	7	6	5	4	3	2	1	0
0	Length (not including the checksum)							
1	SSI_MGMT_COMMAND (0x80)							
2	Message Source (0 - Decoder)							
3	Reserved (0)			Reserved (0)		Reserved (0)	Cont'd packet	Retransmit
4	Payload data (see the following example)							
...								
Length -1								
Length	2's complement checksum (MSB)							
Length +1	2's complement checksum (LSB)							

## Example Transaction

The following example illustrates how to retrieve diagnostic information (Diagnostic Testing and Reporting - Attribute #10061- decimal) from the scanner using encapsulation of RSM commands over SSI. Before

sending an RSM command, the host must send the RSM Get Packet Size command to query the packet size supported by the device.

### Command from Host to Query Packet Size Supported by Device

```
0A 80 04 00 00 06 20 00 FF FF FD 4E
```

Where:

- 0A 80 04 00 is encapsulation of RSM commands over SSI command header
- 00 06 20 00 FF FF is RSM Get Packet Size command
- FD 4E is SSI command checksum

### Response from Device with Packet Size Information

```
0C 80 00 00 00 08 20 00 00 F0 00 F0 FD 6C
```

Where:

- 0C 80 00 00 is encapsulation of RSM command over SSI command header
- 00 08 20 00 00 F0 00 F0 is RSM Get Packet Size response
- FD 6C is SSI response checksum

### Command from Host to Retrieve Diagnostic Information

```
0C 80 04 00 00 08 02 00 27 4D 42 00 FE B0
```

Where:

- 0C 80 04 00 is encapsulation of RSM commands over SSI command header
- 00 08 02 00 27 4D 42 00 is attribute Get command requesting attribute 10061 decimal
- FE B0 is SSI command checksum

### Response from Device with Diagnostic Information

```
21 80 00 00 00 1D 02 00 27 4D 41 01 42 00 0E 00 00 00 00 01 03 02 03 03 04  
03 05 03 06 03 FF FF FC 15
```

Where:

- 21 80 00 00 00 1D 02 00 27 4D 41 01 42 00 0E 00 00 is encapsulation of RSM responses over SSI command header
- 00 00 01 03 02 03 03 03 04 03 05 03 06 03 is attribute Get response which includes diagnostic report value
- FF FF is attribute Get response, packet termination
- FC 15 is SSI response checksum

## Setting SSI Parameters

You can set up a scanner with an SSI host. When using SSI, program the scanner via barcode menu or SSI hosts commands

The scanner ships with the settings shown in [SSI Interface Defaults](#) (also see for all defaults). If the default values suit requirements, programming is not necessary.

To set feature values, scan a single barcode or a short barcode sequence. The settings are stored in non-volatile memory and are preserved even when the scanner powers down.

To return all features to default values, scan [Set Factory Defaults](#). Throughout the programming barcode menus, asterisks (\*) indicate default values.

## SSI Scanning Sequence Examples

In most cases scanning one barcode sets the parameter value. For example, to set the baud rate to 19,200, scan the **Baud Rate 19,200** barcode under [Baud Rate](#). The scanner issues a fast warble beep and the LED turns green, signifying a successful parameter entry.

Other parameters require scanning several barcodes. See the parameter descriptions for this procedure.

## SSI Errors While Scanning

Unless otherwise specified, to correct an error during a scanning sequence, just re-scan the correct parameter.

## SSI Interface Parameter Defaults

The following table lists defaults for SSI host parameters.

You can change these values in one of two ways:

- Scan the appropriate barcodes in this section. The new value replaces the standard default value in memory. To recall default parameter values, see [Default Parameters](#).
- Download data through the device's serial port using SSI. Hexadecimal parameter numbers appear in this chapter below the parameter title, and option values appear in parenthesis beneath the accompanying barcodes. Refer to the Simple Serial Interface (SSI) Programmer's Guide for detailed instructions for changing parameters using this method.

**Table 12** SSI Interface Default Table

Parameter	Parameter Number	SSI Number	Default
<b>SSI Host Parameters</b>			
<a href="#">Select SSI Host</a>	N/A	N/A	N/A
<a href="#">Baud Rate</a>	156	9Ch	9600
<a href="#">Parity</a>	158	9Eh	None
<a href="#">Check Parity</a>	151	97h	Disable
<a href="#">Stop Bits</a>	157	9Dh	1

**Table 12** SSI Interface Default Table (Continued)

Parameter	Parameter Number	SSI Number	Default
<a href="#">Software Handshaking</a>	159	9Fh	ACK/NAK
<a href="#">Host RTS Line State</a>	154	9Ah	Low
<a href="#">Decode Data Packet Format</a>	238	EEh	Send Raw Decode Data
<a href="#">Host Serial Response Timeout</a>	155	9Bh	2 Seconds
<a href="#">Host Character Timeout</a>	239	EFh	200 msec
<a href="#">Multipacket Option</a>	334	F0h 4Eh	Multipacket Option 1
<a href="#">Interpacket Delay</a>	335	F0h 4Fh	0 msec
<b>Event Reporting</b>			
<a href="#">Decode Event</a>	256	F0h 00h	Disable
<a href="#">Boot Up Event</a>	258	F0h 02h	Disable
<a href="#">Parameter Event</a>	259	F0h 03h	Disable



**NOTE:** SSI interprets Prefix, Suffix1, and Suffix2 values listed in [ASCII Character Sets](#) differently than other interfaces. SSI does not recognize key categories, only the 3-digit decimal value. The default value of 7013 is interpreted as CR only.

## SSI Host Parameters

Scan barcodes to set SSI host parameters

### Select SSI Host

Use this parameter to select SSI as the host interface.



SSI Host

### SSI Baud Rate

#### Parameter # 156 (SSI # 9Ch)

Baud rate is the number of bits of data transmitted per second.

Select an option to set the scanner's baud rate to match the baud rate setting of the host device. Otherwise, data may not reach the host device or may reach it in distorted form.

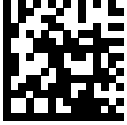

\*Baud Rate 9600 (0)



Baud Rate 19,200 (7)



Baud Rate 38,400 (8)



Baud Rate 57,600 (9)



Baud Rate 115,200 (10)



Baud Rate 230,400 (11)



Baud Rate 460,800 (12)



Baud Rate 921,600 (13)

### SSI Parity

Parameter # 158 (SSI # 9Eh)

Choose whether code characters contain an odd or even number of 1 bits, or choose that no parity bit is required.

A parity check bit is the most significant bit of each ASCII coded character. Use this parameter to select the parity type according to host device requirements.

- Odd - This sets the parity bit value to 0 or 1, based on data, to ensure that the coded character contains an odd number of 1 bits.
- Even - This sets the parity bit value to 0 or 1, based on data, to ensure that the coded character contains an even number of 1 bits.
- None - No parity bit is required.



Odd (2)

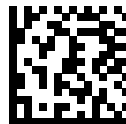

Even (1)



\*None (0)

## Check Parity

### Parameter # 151 (SSI # 97h)

Choose whether to check the parity of received characters.

Use this parameter to select whether to check the parity of received characters. See [SSI Parity](#) to select the type of parity.



\*Do Not Check Parity (0)

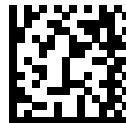

Check Parity (1)

## SSI Stop Bits

### Parameter # 157 (SSI # 9Dh)

The stop bit(s) at the end of each transmitted character marks the end of transmission of one character and prepares the receiving device for the next character in the serial data stream.

Select an option to set the number of stop bits (one or two) based on the number the receiving host can accommodate.



\*1 Stop Bit (1)



2 Stop Bits (2)

## Software Handshaking

### Parameter # 159 (SSI # 9Fh)

This parameter offers control of data transmission in addition to the control hardware handshaking offers. Hardware handshaking is always enabled; you cannot disable it.

- Disable ACK/NAK Handshaking - The scanner neither generates nor expects ACK/NAK handshaking packets.
- Enable ACK/NAK Handshaking - After transmitting data, the scanner expects either an ACK or NAK response from the host. The scanner also ACKs or NAKs messages from the host. The scanner waits up to the programmable [Host Serial Response Timeout](#) to receive an ACK or NAK. If the scanner does not get a response in this time, it resends its data up to two times before discarding the data and declaring a transmission error.



Disable ACK/NAK (0)



\*Enable ACK/NAK (1)

## Host RTS Line State

### Parameter # 154 (SSI # 9Ah)

This parameter sets the expected idle state of the Serial Host RTS line.

The SSI interface is used with host applications that also implement the SSI protocol. However, you can use the scanner in a "scan-and-transmit" mode to communicate with any standard serial communication software on a host PC (see [Decode Data Packet Format](#)). If transmission errors occur in this mode, the host PC may be asserting hardware handshaking lines that interfere with the SSI protocol. Scan the High barcode to address this problem.



\*Low (0)



High (1)

## Decode Data Packet Format

### Parameter # 238 (SSI # EEh)

Use this parameter to select whether to transmit decoded data in raw format (unpacked), or with the packet format defined by the serial protocol.



**NOTE:** Selecting the raw format disables ACK/NAK handshaking for decode data.



\*Send Raw Decode Data (0)



Send Packeted Decode Data (1)

## Host Serial Response Timeout (SSI)

### Parameter # 155 (SSI # 9Bh)

This parameter specifies how long a scanner waits for an ACK or NAK before resending.

If the scanner wants to send, and the host has already been granted permission to send, the scanner waits for the designated timeout before declaring an error.



**NOTE:** Other values are available via SSI command.



\*Low - 2 Seconds (20)



Medium - 5 Seconds (50)



High - 7.5 Seconds (75)



Maximum - 9.9 Seconds (99)

### Host Character Timeout

#### Parameter # 239 (SSI # EFh)

This parameter specifies the maximum time a scanner waits between characters transmitted by the host before discarding the received data and declaring an error.

Select an option to specify the maximum time the scanner waits from Low to High.



**NOTE:** Other values are available via SSI command.



\*Low - 200 msec (20)

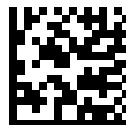

Medium - 500 msec (50)



High - 750 msec (75)



Maximum - 990 msec (99)

## Multipacket Option

### Parameter # 334 (SSI # F0h 4Eh)

This parameter controls ACK/NAK handshaking for multi-packet transmissions.

- Multi-Packet Option 1 - The host sends an ACK/NAK for each data packet during a multi-packet transmission.
- Multi-Packet Option 2 - The scanner sends data packets continuously, with no ACK/NAK handshaking to pace the transmission. The host, if overrun, can use hardware handshaking to temporarily delay scanner transmissions. At the end of transmission, the scanner waits for a CMD\_ACK or CMD\_NAK.
- Multi-Packet Option 3 - This is the same as option 2 with the addition of a programmable interpacket delay. See [Interpacket Delay](#) to set this delay.



\*Multipacket Option 1 (0)



Multipacket Option 2 (1)



Multipacket Option 3 (2)

## Interpacket Delay

### Parameter # 335 (SSI # F0h 4Fh)

This parameter specifies the interpacket delay if you selected Multipacket Option 3.



**NOTE:** Other values are available via SSI command.



\*Minimum - 0 msec (0)



Low - 25 msec (25)



Medium - 50 msec (50)



High - 75 msec (75)



Maximum - 99 msec (99)

## Decode Event

### Parameter # 256 (SSI # F0h 00h)

Use this parameter to enable or disable a non-parameter decode event.

- Enable Decode Event - scanner generates a message to the host upon a successful barcode decode.
- Disable Decode Event - no notification is sent.



Enable Decode Event (1)



\*Disable Decode Event (0)

## Boot Up Event

### Parameter # 258 (SSI # F0h 02h)

Use this parameter to enable or disable a system power-up event.

- Enable Boot Up Event - scanner generates a message to the host whenever power is applied.
- Disable Boot Up Event - no notification is sent.



Enable Boot Up Event (1)



\*Disable Boot Up Event (0)

## Parameter Event

### Parameter # 259 (SSI # F0h 03h)

Use this parameter to enable or disable parameter events.

- Enable Parameter Event - scanner generates a message to the host when one of the events specified in [Event Reporting](#) occurs.
- Disable Parameter Event - no notification is sent.



Enable Parameter Event (1)

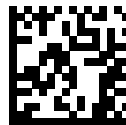

\*Disable Parameter Event (0)

# User Preferences and Miscellaneous Options

You can program the scanner to perform various functions or activate different features. This section describes user preference features and provides programming barcodes for selecting these features.

The scanner ships with the settings shown in [Symbology Parameter Defaults](#). If the default values suit requirements, programming is not necessary.

## Setting User Preference Parameters

To set feature values, scan a single barcode or a short barcode sequence. The settings are stored in non-volatile memory and are preserved even when the scanner powers down.



**NOTE:** Most computer monitors allow scanning barcodes directly on the screen. When scanning from the screen, be sure to set the document magnification to a level where you can see the barcode clearly, and bars and/or spaces do not merge.

If not using the default host, select the host type (see each host section for specific host information) after the power-up beeps sound. This is only necessary upon the first power-up when connected to a new host.

To return all features to default values, see [Default Parameters](#). Throughout the programming barcode menus, asterisks indicate (\*) default values.

## User Preference Scanning Sequence Examples

In most cases, scanning one barcode sets the parameter value.

Other parameters require scanning several barcodes. Relevant parameters contain descriptions for this procedure.

## User Preference Errors While Scanning

Unless otherwise specified, to correct an error during a scanning sequence, re-scan the correct parameter.

## User Preferences Parameter Defaults

This table provides a list of the User Preference parameter default values. To change the device's behavior, scan the relevant barcodes in this section.

**Table 13** Parameter Default Table

Parameter	Parameter Number	SSI Number	Parameter Default
<b>User Preferences</b>			
Set Default Parameter	N/A	N/A	N/A
Report Software Version	N/A	N/A	N/A
Parameter Barcode Scanning	236	ECh	Enable
Beep After Good Decode	56	38h	Beep
Beeper Volume	140	8Ch	High
Beeper Tone	145	91h	Medium
Beeper Duration	628	F1h 74h	Medium
Suppress Power Up Beeps	721	F1h D1h	Do Not Suppress Power-Up Beeps
LED Brightness	1317	F8h 05h 25h	High
LED on Good Decode	744	F1h E8h	Enable LED on Good Decode
Decode Session Timeout	136	88h	99
Hands-Free Decode Session Timeout	400	F0h 90h	15
Timeout Between Decodes, Same Symbol	137	89h	5
Timeout Between Decodes, Different Symbols	144	90h	1
Mobile Phone / Display Mode (Enhanced)	716	F1h CCh	Normal Mobile Phone/Display Mode
Motion Detect Mode (Wakeup)	2377	F8 09 49	IR Detect
PDF Prioritization	719	F1h CFh	Disable
PDF Prioritization Timeout	720	F1h D0h	200
Decoding Illumination	298	F0h 2Ah	Enable Decoding Illumination
Illumination Brightness	669	F1h 9Dh	Medium
Product ID (PID) Type	1281	F8h 05h 01h	Host Type Unique
Product ID (PID) Value	1725	F8h 06h BDh	0
<b>Miscellaneous Options</b>			
Enter Key	N/A	N/A	Enable
Tab Key	N/A	N/A	N/A
Transmit Code ID Character	45	2Dh	None

**Table 13** Parameter Default Table (Continued)

Parameter	Parameter Number	SSI Number	Parameter Default
Scan Data Transmission Format	235	EBh	<Data> <Suffix>
Transmit No Read Message	94	5Eh	Disable
Unsolicited Heartbeat Interval	1118	F8h 04h 5Eh	0
securPharm Decoding	1752	F8h 06h D8h	Disable securPharm Decoding
securPharm Output Formatting	1753	F8h06hD9h	No Formatting

## User Preferences

Set feature values by scanning the desired parameter values.

### Set Default Parameter

This parameter returns all parameters to the default values.

See the default value tables in each section.



\*Set All Defaults

### Report Software Version

When contacting support, a support representative may ask you to scan the bar code below to determine the version of software installed in the digital scanner.

### Parameter Barcode Scanning

#### Parameter # 236 (SSI # ECh)

This parameter selects whether to enable or disable the decoding of parameter barcodes, including the **Set Defaults** barcodes.



\*Enable Parameter Barcode Scanning (1)



Disable Parameter Barcode Scanning (0)

## Beep After Good Decode

### Parameter # 56 (SSI # 38h)

This parameter selects whether or not the scanner beeps after a good decode. If you select **Disable Beep After Good Decode**, the beeper still operates during parameter menu scanning and to indicate error conditions.



\*Enable Beep After Good Decode (1)



Disable Beep After Good Decode (0)

## Beeper Volume

### Parameter # 140 (SSI # 8Ch)

This parameter selects a beeper volume.



Low Volume (2)



Medium Volume (1)



\*High Volume (0)

## Beeper Tone

### Parameter # 145 (SSI # 91h)

This parameter selects a beeper tone for a good decode beep.



Disable Tone (3)



Low Tone (2)



\*Medium Tone (1)



High Tone (0)



Medium to High Tone (2-tone) (4)

### Beeper Duration

#### Parameter # 628 (SSI # F1h 74h)

This parameter selects the duration for the good decode beep.



Short Duration (0)



\*Medium Duration (1)



Long Duration (2)

### Suppress Power Up Beeps

#### Parameter # 721 (SSI # F1h D1h)

This parameter selects whether or not to suppress the scanner's power-up beeps.



\*Do Not Suppress Power Up Beeps (0)



Suppress Power Up Beeps (1)

### Indicator LED Brightness

#### Parameter # 1317 (SSI # F8h 05h 25h)

This parameter controls the brightness of the LED indicator bars during normal operation.

The SP20 LED brightness has two options: High (default) and Low.



**NOTE:** To change the illumination LED brightness, go to [Illumination Brightness](#).



\*High (1)



Low (0)

### LED on Good Decode

#### Parameter # 744 (SSI # F1h E8h)

This parameter selects whether or not the LED blinks on a good decode.



\*Enable LED on Good Decode (2)



Disable LED on Good Decode (0)

### Decode Session Timeout

#### Parameter # 136 (SSI # 88h)

This parameter sets the maximum time decode processing continues during a scan attempt. It is programmable in 0.1 second increments from 0.5 to 9.9 seconds. The default timeout is 9.9 seconds.

To set a Decode Session Timeout, scan the following barcode, and then scan two barcodes from [Numeric Barcodes](#) that correspond to the desired on time. Enter a leading zero for single digit numbers. For example, to set a Decode Session Timeout of 0.5 seconds, scan this barcode, and then scan the 0 and 5 barcodes. To correct an error or change the selection, scan [Cancel](#).



Decode Session Timeout

### Trigger Mode

#### Parameter # 138 (SSI # 8Ah)

This parameter allows you to change your scanner's behavior to initiate a decode.

Choose one of the following to select a trigger mode for the scanner:

- Standard (Level) - A software trigger press activates decode processing. Decode processing continues until the barcode decodes, you release the software trigger or the [Decode Session Timeout](#) occurs. If the software trigger is released before the timeout expires, the decode session terminates and no decode occurs.
- Presentation (Blink) - The scanner activates decode processing when it detects a barcode in its field of view. After a period of non-use, the LEDs turn off until the scanner senses motion.



Standard (Level) (0)



\*Presentation (Blink) (7)

## Hands-Free Decode Session Timeout

### Parameter # 400 (SSI # F0 90)

This parameter is the hands-free compliment to the Decode Session Timeout. It configures the minimum and maximum decode processing time during a hands-free scan attempt. It only applies to the hands-free trigger mode or when a scanner is placed in the gooseneck stand.

The range for this parameter is 0-255 with a default value of 15.

The minimum decode processing time is defined as the time in which the scanner stops decoding when an object is removed or left stationary in the imaging field of view.

The maximum decode processing time is defined as the time in which the scanner stops decoding when an object remains in or is moving in the field of view.

Both the maximum and minimum times are configured using a single setting. The relationship of this setting is as follows:

Setting Value <sup>a</sup>	Minimum Time	Maximum Time
X < 25	250 ms	2.5 seconds
X >= 25	X * 10 ms	X * 100 ms

<sup>a</sup> value must be three digits.

For example, a value of 100 causes the scanner to turn off for approximately 1 second after an object is removed from the field of view or 10 seconds while an object is in the field of view moving.

The default value of the setting is 15, which results in a minimum time of 150 ms and a maximum time of 1.5 sec.

Adjust this setting based on your requirements. For example, this parameter should be set to a value where the maximum time is above the PDF prioritization timeout value when the scanner uses PDF prioritization .

To set a three-digit value, scan the following barcode and then scan three barcodes from [Numeric Barcodes](#). Enter a leading zero for single-digit numbers. To correct an error or change a selection, scan Cancel.



Hands-Free Decode Session Timeout

## Timeout Between Decodes, Same Symbol

### Parameter # 137 (SSI # 89h)

Use this option in Presentation Mode or Continuous Barcode Read Mode to prevent the scanner from continuously decoding the same barcode while it remains in the scanner's field of view. The barcode must be removed from the field of view for the timeout period before the scanner reads the same consecutive symbol.

Timeout Between Decodes, Same Symbol is programmable in 0.1 second increments from 0.0 to 9.9 seconds. The default interval is 0.5 seconds.

To select the timeout between decodes for the same symbol, scan the following barcode, and then scan two barcodes from [Numeric Barcodes](#) that correspond to the desired interval, in 0.1 second increments.



Timeout Between Decodes, Same Symbol

### Timeout Between Decodes, Different Symbols

#### Parameter # 144 (SSI # 90h)

This parameter controls the time the scanner waits before decoding a different symbol. Use this parameter when the scanner is in Presentation Mode or Continuous Barcode Read.

Timeout Between Decodes, Different Symbols is programmable in 0.1 second increments from 0.1 to 9.9 seconds. The default is 0.1 seconds.

To set the timeout for decoding different symbols, scan the following barcode, and then scan two barcodes from [Numeric Barcodes](#) that correspond to the desired interval, in 0.1 second increments.



Timeout Between Decodes, Different Symbols

### Motion Detection Mode

#### Parameter # 2377 (SSI #F8 09 49)

This parameter selects the method used to detect motion and activate a decode session.

- IR Detect: A decode session is triggered when the infrared proximity sensor detects a barcode.
- Object Detect: A decode session is triggered when the imaging sensor detects a barcode. Illumination increases, and decoding is enabled. Object detection mode requires some illumination to detect an object, such as a barcode.



\*IR Detect (3)



Object Detect (1)

## Mobile Phone/Display Mode

### Parameter # 716 (SSI # F1h CCh)

This mode improves barcode reading performance off mobile phones and electronic displays. Scan one of the following barcodes to select the desired mode.

Mobile barcodes include barcodes on mobile phone displays, PC displays, or other reflective surfaces such as clear plastic bags or cellophane wrapping. Printed barcodes include barcodes printed on paper or other non-reflective surfaces.



\*(0)



(2)

## PDF Prioritization

### Parameter # 719 (SSI # F4h F1h CFh)

Enable this parameter to delay decoding certain 1D barcodes by the value specified in PDF Prioritization Timeout.

During the [PDF Prioritization Timeout](#) time, the scanner attempts to decode a PDF417 symbol (for example, on a US driver's license), and if successful, reports this only. If it does not decode (cannot find) a PDF417 symbol, it reports the 1D symbol after the timeout. The 1D symbol must be in the device's field of view for the scanner to report it. This parameter does not affect decoding other symbologies.

The 1D Code 128 barcode lengths include the following:

- 7 to 10 characters
- 14 to 22 characters
- 27 to 28 characters

In addition, a Code 39 barcode with the following lengths are considered to potentially be part of a US driver's license:

- 8 characters
- 12 characters



Enable PDF Prioritization (1)



\*Disable PDF Prioritization (0)

### PDF Prioritization Timeout

#### Parameter # 720 (SSI # F1h D0h)

If you enabled PDF Prioritization, set this timeout to indicate how long the scanner attempts to decode a PDF417 symbol before reporting the 1D barcode in the field of view.

The PDF Prioritization Timeout range is 0 to 5000 ms, and the default is 200 ms.

Scan the following barcode, and then scan four barcodes from [Numeric Barcodes](#) that specify the timeout in milliseconds. For example, to enter 400 ms, scan the following barcode, and then scan 0400.

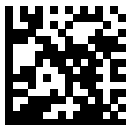

PDF Prioritization Timeout

### Decoding Illumination

#### Parameter # 298 (SSI # F0h 2Ah)

This parameter determines whether the scanner turns on illumination to aid decoding. Enabling illumination usually results in superior images and better decode performance. The effectiveness of the illumination decreases as the distance to the target increases.

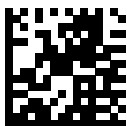

\*Enable Decoding Illumination (1)

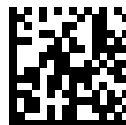

Disable Decoding Illumination (0)

### Illumination Brightness

#### Parameter # 669 (SSI # F1h 9Dh)

This parameter sets the illumination brightness by altering LED power.

Illumination Brightness values range from 1 to 10, with 10 being the highest level of brightness. The default is 5.

To set the illumination brightness, scan the following barcode, and then scan two barcodes in [Numeric Barcodes](#) that correspond to the value of desired illumination brightness. For example, to set illumination brightness to 8, scan the Illumination Brightness barcode, and then scan the 0 and 8 barcodes.



Illumination Brightness

### Miscellaneous Scanner Parameters

This section provides additional barcodes and parameters for miscellaneous options.

#### Transmit Code ID Character

##### Parameter # 45 (SSI # 2Dh)

A Code ID character identifies the code type of a scanned barcode. This is useful when decoding more than one code type. In addition to any single character prefix selected, the Code ID character is inserted between the prefix and the decoded symbol.

The Code ID character options are:

- No Code ID character
- Symbol Code ID character
- AIM Code ID character

For Code ID characters, see [Symbol Code Identifiers](#) and [AIM Code Identifiers](#).



Symbol Code ID Character (2)



AIM Code ID Character (1)



\*None (0)

#### Scan Data Transmission Format

##### Parameter # 235 (SSI # EBh)

This parameter selects the scan data format.



**NOTE:** If using this parameter do not use ADF rules to set the prefix/suffix.

To set values for the prefix or suffix, see [Prefix Suffix Values](#).



Data As Is (0)



\*<DATA> <SUFFIX 1> (1)



<DATA> <SUFFIX 2> (2)



<DATA> <SUFFIX 1> <SUFFIX 2> (3)



<PREFIX> <DATA > (4)



<PREFIX> <DATA> <SUFFIX 1> (5)



<PREFIX> <DATA> <SUFFIX 2> (6)



<PREFIX> <DATA> <SUFFIX 1> <SUFFIX 2> (7)

### Transmit No Read Message

#### Parameter # 94 (SSI # 5Eh)

This parameter sets an option for transmitting the No Read (NR) characters.



**NOTE:** If you enable Transmit No Read, and also enable Symbol Code ID Character or AIM Code ID Character for [Transmit Code ID Character](#), the scanner appends the code ID for Code 39 to the NR message.

This does not apply in presentation mode.

- Enable No Read - transmits the characters NR when a successful decode does not occur before software trigger release or the [Decode Session Timeout](#) expires.
- Disable No Read - sends nothing to the host if a symbol does not decode.



Enable No Read (1)



\*Disable No Read (0)

### Unsolicited Heartbeat Interval

#### Parameter # 1118 (SSI # F8h 04h 5Eh)

When this parameter is enabled, the scanner can send unsolicited heartbeat messages to assist in diagnostics. The range is 0 - 9999.

The heartbeat event is sent as decode data (with no decode beep) in the form of:

```
MOTEVTHB : nnn
```

Where: nnn is a three-digit sequence number starting at 001 and wrapping after 100.

To enable this parameter and set the desired unsolicited heartbeat interval, scan one of the following time interval barcodes, or scan Set Another Interval followed by four barcodes from [Numeric Barcodes](#) that correspond to the desired number of seconds.

Scan Disable Unsolicited Heartbeat Interval to turn off the feature.



10 Seconds (10)

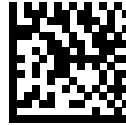

1 Minute (60)



Set Another Interval

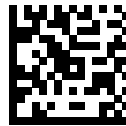

\*Disable Unsolicited Heartbeat Interval (0)

### securPharm Decoding

#### Parameter # 1752 (SSI # F8h 06h D8h)

securPharm implements the IFA and GS1 Coding System for the European pharmaceutical industry. securPharm code is used to prevent pharmaceutical counterfeiting. This parameter enables or disables the ability to process pharmaceutical type barcodes.

When this feature is enabled, if a GS1 symbol is decoded and includes any aspects of the Application Identifier associated with the securPharm GS1 specifications, the entire GS1 symbol is processed as a securPharm symbol. For this reason, it is expected that under certain circumstances, a GS1 barcode that is a securPharm symbol may not be processed properly; if the GS1 symbol is not created as per the specification. The output cannot be guaranteed as valid.

Although the GS1-128 type and the GS1 DataBar family are not specifically indicated in the IFA specification, they are supported.

The securPharm output is in XML format and can include the product number, serial number, lot number, expiration and Date of Manufacturing. The XML tags can be arranged in any order. Tags that are not in the barcode are omitted. For example:

```
<content dfi="value_dfi">
  <Daten_1>value_Daten_1</Daten_1>
  <Daten_2>value_Daten_2</Daten_2>
  <Daten_n>value_Daten_n</Daten_n
</content>
```

Where:

- value\_dfi = IFA or GS1
- Daten\_1 to Daten\_n is the production number, serial number, etc.



\*Disable securPharm Decoding (0)



Enable securPharm Decoding (1)

## securPharm Output Formatting

### Parameter # 1753 (SSI # F8h 06h D9h)

securPharm Output Formatting parameter options represent bit positions. Therefore, any combination of formatting can be used.



**NOTE:** securPharm output formatting is effective only when [securPharm Decoding](#) is enabled.

When you scan a securPharm Output Formatting barcode, the securPharm output is formatted in a number of ways.

### Sample GS1 Format

Product Number: GTIN Data Identifier DI Data Format Identifier: GS1



### Sample GS1 Output - Feature Disabled

The output has no format:

```
0104150123456782101A234B517151231211234567890123456
```

### Sample GS1 Output - No Formatting (0)

The output is a single line of characters:

```
<content dfi="GS1"><gtin>04150123456782</gtin><lot>1A234B5</lot><exp>151231</exp><sn>1234567890123456</sn></content>
```

### Sample GS1 Output - Insert Tab (1)

The output is a single line of characters with a tab inserted in the XML body:

```
<content dfi="GS1">[tab]<gtin>04150123456782</gtin>[tab]<lot>1A234B5</lot>[tab]<exp>151231</exp>[tab]<sn>1234567890123456</sn></content>
```

### Sample GS1 Output - Insert New Line (2)

The output consists of multiple lines of characters with a new line character at the end of each line.

```
<content dfi="GS1">
<gtin>04150123456782</gtin>
<lot>1A234B5</lot>
<exp>151231</exp>
<sn>1234567890123456</sn>
</content>
```

### Sample GS1 Output - Insert Tab and New Line (3)

The output consists of multiple lines of characters with tabs and a new line character at the end of each line.

```
<content dfi="GS1">
[tab] <gtin>04150123456782</gtin>
[tab] <lot>1A234B5</lot>
[tab] <exp>151231</exp>
[tab] <sn>1234567890123456</sn>
</content>
```

### Sample IFA Format

Product Number: PPN Data Identifier DI Data Format Identifier: IFA



### Sample GS1 Output - Feature Disabled

The output has no format:

```
[ ]>069N1112345678421T1A234B5S1234567890123456
```

### Sample GS1 Output - No Formatting (0)

The output is a single line of characters:

```
<content dfi="IFA"><ppn>111234567842</ppn><lot>1A234B5</lot><sn>1234567890123456</sn></content>
```

### Sample GS1 Output - Insert Tab (1)

The output is a single line of characters with a tab inserted in the XML body:

```
<content dfi="IFA">[tab]<ppn>111234567842</ppn>[tab]<lot>1A234B5</lot>[tab]<sn>1234567890123456</sn></content>
```

### Sample GS1 Output - Insert New Line (2)

The output consists of multiple lines of characters with a new line character at the end of each line.

```
<content dfi="IFA">
<ppn>111234567842</ppn>
<lot>1A234B5</lot>
<sn>1234567890123456</sn>
</content>
```

### Sample GS1 Output - Insert Tab and New Line (3)

The output consists of multiple lines of characters with tabs and a new line character at the end of each line.

```
<content dfi="IFA">
[tab] <ppn>111234567842</ppn>
[tab] <ppn>111234567842</ppn>
[tab] <lot>1A234B5</lot>
[tab] <sn>1234567890123456</sn>
</content>
```

### securPharm Output Formatting Barcodes

Scan a barcode below to format the securPharm output.



\*No Formatting (0)



Insert Tab (1)



Insert New Line (2)

# Image Capture Preferences

You can program the imager to perform various functions, or you can activate different features. This section describes image capture preference features and provides programming barcodes for selecting these features.



**NOTE:** Only the Symbol Native API (SNAPI) with Imaging interface supports image capture. See [USB Device Type](#) to enable this host.

## Setting Image Capture Parameters

To set feature values, scan a single barcode or a short barcode sequence. The settings are stored in non-volatile memory and are preserved even when the imager powers down.



**NOTE:** Most computer monitors allow scanning barcodes directly on the screen. When scanning from the screen, be sure to set the document magnification to a level where you can see the barcode clearly, and bars and/or spaces do not merge.

## Image Capture Scanning Sequence Examples

You can scan a barcode to set a parameter value.

For example, to disable image capture illumination, scan the Disable Image Capture Illumination barcode found in [Image Capture Illumination](#). After enabling this setting, the imager issues a fast warble beep and the LED turns green, signifying a successful parameter entry.

Other parameters require scanning several barcodes. See the parameter descriptions for this procedure.

## Image Capture Errors While Scanning

Unless otherwise specified, to correct an error during a scanning sequence, just re-scan the correct parameter.

## Image Capture Preferences Parameter Defaults

The image capture preferences parameter defaults lists defaults for image capture preference parameters.

- Scan the appropriate barcodes in this chapter. The new value replaces the standard default value in memory. To recall default parameter values, see [Default Parameters](#).
- Configure the scanner using the 123Scan configuration program. See [123Scan and Software Tools](#).

## Image Capture Preferences

**Table 14** Parameter Default Table

Parameter	Parameter Number	SSI Number	Parameter Default
<b>Image Capture</b>			
Presentation Mode Field of View	609	F1h 61h	Full
Image Capture Autoexposure	360	F0h 68h	Enable
Fixed Exposure	567	F1h37h	100
Analog and Digital Gain	1232	F8h04hD0h	1
Digital Gain	1233	F8h 04h D1h	32
Image Capture Illumination	361	F0h69h	1
Image Brightness (Target White)	390	F0h 86h	180
Image Size (Number of Pixels)	302	F0h 2Eh	Full
Image Enhancement	564	F1h 34h	Low
Image File Format Selector	304	F0h 30h	JPEG
Bits Per Pixel	303	F0h 2Fh	8 BPP
Image Rotation	665	F1h 99h	None
<b>JPEG Image Optimization</b>			
JPEG Image Options	299	F0h 2Bh	JPEG Quality Selector
JPEG Size Value	561	F1h 31h	160
JPEG Quality Value	305	F0h 31h	65
<b>Snapshot Mode</b>			
Gain/Exposure Priority for Snapshot Mode	562	F1h 32h	Autodetect
Snapshot Mode Timeout	323	F0h 43h	30 sec
Silence Operational Mode Changes	1293	F8h05h0Dh	0
<b>Image Cropping</b>			
Image Cropping	301	F0h 2Dh	Disable
Crop to Pixel Addresses	Top Pixel Address: 315 Left Pixel Address: 316 Bottom Pixel Address: 317 Right Pixel Address: 318	F0h 3Bh F0h 3Ch F0h 3Dh F0h 3Eh	0h 0 799 1279

## Image Capture Preferences Modes and Parameters

The parameters in this section control image capture characteristics.

### Operational Modes

The scanner can have up to two modes of operation.

- Decode Mode
- Snapshot Mode

#### Decode Mode

By default, the scan module attempts to locate and decode enabled barcodes within its field of view.

#### Snapshot Mode

Use Snapshot Mode to capture a high-quality image and transmit it to the host. Select the Snapshot Mode option to temporarily enter this mode. While in this mode the imager blinks the green LED at one-second intervals to indicate it is not in standard operating (decode) mode.

In this mode the scanner will transmit video to the host to allow the user to locate the image they want to be taken. The scanner does not have a trigger, as a result the scanner will rely on a software trigger command from the host. Supported only in SNAPi and SSI protocols.

In Snapshot Mode, the imager turns on its illumination to highlight the area to capture in the image. The next trigger command instructs the imager to capture a high-quality image and transmit it to the host. A short time may pass (less than two seconds) between when the command is received and when the image is captured as the imager adjusts to lighting conditions.

If you do send a trigger command within the Snapshot Mode Timeout period, the imager returns to Decode Mode. Use [Snapshot Mode Timeout](#) to adjust this timeout period. The default timeout period is 30 seconds.



Snapshot Mode

### Presentation Mode Field of View

#### Parameter # 609 (SSI # F1h 61h)

This parameter sets the size of the search area.

In presentation mode, the default setting of Full Field of View allows the scanner to search the entire area of the imaging field of view.

Select Small Field of View or Medium Field of View to search for a barcode in a smaller centered region of the imaging field of view to speed search time.



Small Field of View (0)

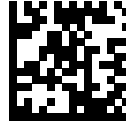

Medium Field of View (1)



\*Full Field of View (2)

## Image Capture Autoexposure

### Parameter # 360 (SSI # F0h 68h)

This parameter enables the imager to control gain and exposure (integration time) settings to best capture an image for Snapshot mode.

- Enabled - Allows the imager to control gain and exposure settings to best capture an image.
- Disabled - Manually adjust the gain and exposure time.



**NOTE:** Disabling Image Capture Autoexposure is only recommended for advanced users with difficult image capture situations.



\*Enable Image Capture Autoexposure (1)

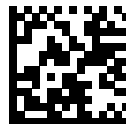

Disable Image Capture Autoexposure (0)

## Fixed Exposure

### Parameter # 567 (SSI # F4h F1h 37h)

This parameter configures the exposure used in manual mode for Snapshot and Video modes. Each integer value represents 100 microseconds of exposure. The default value is 100 which results in an exposure setting of 10 ms.

Type: Word

Range: 5 to 1000

To set the exposure, scan the Fixed Exposure barcode, and then scan four barcodes from [Numeric Barcodes](#) representing the value. Leading zeros are required. For example, to set a Fixed Exposure value of 99, scan 0, 0, 9, 9.



Fixed Exposure (4 digits)

## Analog and Digital Gain

### Parameter # 1232

If you disable Decoding Autoexposure or Image Capture Autoexposure, you can use this parameter to modify the engine's analog and digital gain. Total gain = analog gain x digital gain.

## Digital Gain

### Parameter # 1233 (SSI # F4h D1h)

This parameter adjusts the digital gain.

A value of 32 = x 1 digital gain; i.e., digital gain = 1/32 x digital gain parameter value.

Scan digital gain, and then scan two barcodes from [Numeric Barcodes](#) to enter a 2-digit value for the digital gain. The default is 32.



Digital Gain

## Image Capture Illumination

### Parameter # 361 (SSI # F0h 69h)

This parameter turns on illumination during every image capture.

- Enabled - Illumination is on during image capture.
- Disabled - Prevents the imager from using illumination.



**NOTE:** This usually results in superior images. The effectiveness of illumination decreases as the distance to the target increases.



\*Enable Image Capture Illumination (1)

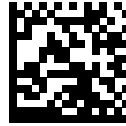

Disable Image Capture Illumination (0)

## Image Brightness (Target White)

### Parameter # 390 (SSI # F0h 86h)

This parameter sets the Target White value used in Snapshot and Video Viewfinder modes when using auto exposure.

Type: Byte

Range: 1 - 240

- Image Brightness (3 digits) - Represents the image brightness value.
- 180 - Sets the white level of the image to ~180.



**NOTE:** White and black are defined as the maximum value decimal and 1, respectively.

Scan Image Brightness, and then scan three barcodes from [Numeric Barcodes](#) representing the value. Leading zeros are required. For example, to set an Image Brightness value of 99, scan 0, 9, 9.



\*180



Image Brightness (3 digits)

## Image Size (Number of Pixels)

### Parameter # 302 (SSI # F0h 2Eh)

This option alters image resolution before compression. Multiple pixels are combined into one pixel, resulting in a smaller image containing the original content with reduced resolution.

Select a resolution value to produce an image size.

**Table 15** Image Size

Resolution Value	Uncropped Image Size
Full	1280 x 800
1/2	640 x 400
1/4	320x200



\*Full Resolution (0)



1/2 Resolution (1)



1/4 Resolution (3)

## Image Enhancement

### Parameter # 564 (SSI # F1h 34h)

This parameter uses a combination of edge sharpening and contrast enhancement to produce an image that is visually pleasing.

Select the level of image enhancement:

- Off (0)
- Low (1)
- Medium (2)
- High (3)



Off (0)

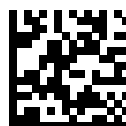

Low (1)



Medium (2)



High (3)

### Image File Format Selector

#### Parameter # 304 (SSI # F0h 30h)

Use this parameter to select an image format appropriate for the system (BMP, TIFF, or JPEG). The imager stores captured images in the selected format.



BMP File Format (3)

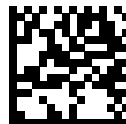

\*JPEG File Format (1)



TIFF File Format (4)

### Bits Per Pixel

#### Parameter # 303 (SSI # F0h 2Fh)

Use this parameter to select the number of significant bits per pixel (BPP) to use when capturing an image.

- 1 BPP - For a black and white image.
- 4 BPP - Assigns 1 of 16 levels of grey to each pixel.
- 8 BPP - Assigns 1 of 256 levels of grey to each pixel.



**NOTE:** The imager ignores these settings for JPEG file formats, which only support 8 BPP. TIFF file formats only support 4 BPP and 8 BPP. Selecting **1 BPP** for TIFF applies the 4 BPP option.



1 BPP (0)



4 BPP (1)



\*8 BPP (2)

## Image Rotation

### Parameter # 665 (SSI # F1h 99h)

Use this parameter to rotate an image by 90-degree increments (0, 90, 180, or 270).



\*Rotate 0° (0)



Rotate 90° (1)



Rotate 180° (2)



Rotate 270° (3)

## JPEG Image Options

### Parameter # 299 (SSI # F0h 2Bh)

This parameter changes the JPEG image quality or size.

- **JPEG Quality Selector** - Enter a quality value via the [JPEG Quality Value](#) parameter; the imager then selects the corresponding image size.
- **JPEG Size Selector** - Enter a size value via the [JPEG Size Value](#) parameter; the imager then selects the best image quality.



\*JPEG Quality Selector (1)



JPEG Size Selector (0)

## JPEG Size Value

**Parameter # 561 (SSI # F1h 31h)**

Type: Word

Range: 5-350

Default:

If you selected **JPEG Size Selector**, use **JPEG Size Value** to set the JPEG size.



**CAUTION:** JPEG compression may take 10 to 15 seconds based on the amount of information in the target image. Selecting [JPEG Quality Selector](#) produces a compressed image that is consistent in quality and compression time.

To set the JPEG size, scan **JPEG Size Value** and then scan three barcodes from [Numeric Barcodes](#) representing the target JPEG file size in kilobytes (KB). Leading zeros are required. For example, to set an image file size value of 99, scan 0, 9, 9.



JPEG Size Value (Default: 160) (3 digits)

## JPEG Quality Value

**Parameter # 305 (SSI # F0h 31h)**

This parameter adjusts the quality of the JPEG.



**NOTE:** Use this parameter if you selected **JPEG Quality Selector** as a JPEG Image Option.

Scan **JPEG Quality Value**, and then scan three barcodes from [Numeric Barcodes](#) corresponding to a value from 5 to 100, where 100 represents the highest quality image. Leading zeros are required. For example, to set an image quality value of 55, scan 0, 5, 5.



JPEG Quality Value (Default: 065) (5 - 100 Decimal)

### Gain/Exposure Priority for Snapshot Mode

#### Parameter # 562 (SSI # F1h 32h)

This parameter alters the imager's gain exposure priority when it acquires an image in Snapshot Mode while in autoexposure mode.

- Low Exposure Priority - The imager favors higher gain over exposure to capture an image, resulting in an image that is less susceptible to motion blur at the expense of noise artifacts. However, for most applications, the amount of noise is acceptable.
- Low Gain Priority - The imager favors longer exposure time rather than higher gain to capture an image, ensuring the image is less noisy and produces fewer artifacts during post processing activities like image enhancement (sharpening). This mode is recommended for fixed mount / fixed object image capture since the image acquired is susceptible to motion blur.
- Autodetect - The imager automatically selects Gain Priority or Low Exposure Priority mode for Snapshot Mode. If the imager is in a magnetic reed switch-enabled stand (or it is configured in Blink Mode), it uses Low Gain Priority. Otherwise, it uses the Low Exposure Priority.



Low Gain Priority (0)



Low Exposure Priority (1)



\*Autodetect (2)

### Snapshot Mode Timeout

#### Parameter # 323 (SSI # F0h 43h)

This parameter sets the amount of time the imager remains in Snapshot Mode.

- Set Snapshot Mode Timeout - scan this parameter and then scan a barcode from [Numeric Barcodes](#). Values increment by 30. For example, 1 = 60 seconds, 2 = 90 seconds.

- 30 Seconds - resets timeout to 30 seconds.
- No Timeout - the imager remains in Snapshot Mode until you initiate a decode session.



Set Snapshot Mode Timeout



\*30 Seconds



No Timeout

## Silence Operational Mode Changes

### Parameter # 1293 (SSI # F8h 05h 0Dh)

This parameter silences the beeper when switching between operational modes (for example, from Decode Mode to Snapshot Mode).

- Enabled - Silences the beep when switching between operational modes.
- Disabled - Allows the beep when switching between operational modes.



Silence Operational Mode Changes (Enable) (1)



\*Do Not Silence Operational Mode Changes (Disable) (0)

## Image Cropping

### Parameter # 301 (SSI # F0h 2Dh)

This parameter crops a captured image to the pixel addresses set in Crop to Pixel Addresses.

- Enabled - Crops the captured image.
- Disabled - Does not crop the captured image.



Enable Image Cropping (1)



\*Disable Image Cropping (Use Full Pixels) (0)

## Crop to Pixel Addresses

**Parameter # 315 (SSI # F4h F0h 3Bh)** (Top)

**Parameter # 316 (SSI # F4h F0h 3Ch)** (Left)

**Parameter # 317 (SSI # F4h F0h 3Dh)** (Bottom)

**Parameter # 318 (SSI # F4h F0h 3Eh)** (Right)

When Image Cropping is enabled, use this parameter to set the pixel addresses.

The pixel addresses value range is (0,0) to 1279 x 799.

- Top Pixel Address - A value with the left pixel address to begin an image crop.
- Left Pixel Address - A value with the top pixel address to begin an image crop.
- Right Pixel Address - A value with the right pixel address to end an image crop.
- Bottom Pixel Address - A value with the right pixel address to end an image crop.

Columns are numbered from 0 to 1279, rows from 0 to 799. Specify values for Top, Left, Bottom, and Right, where Top and Bottom correspond to row pixel addresses, and Left and Right correspond to column pixel addresses.



**NOTE:** The imager has a cropping resolution of 4 pixels. Setting the cropping area to less than 4 pixels (after resolution adjustment, see [Image Size](#)) transfers the entire image.

To crop to the pixel addresses, enable Image Cropping, and then scan four barcodes from [Numeric Barcodes](#) representing the value.



Top Pixel Address (0 - 799 Decimal)



Left Pixel Address (0 - 1279 Decimal)

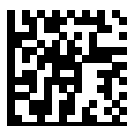

Bottom Pixel Address (0 - 799 Decimal)



Right Pixel Address (0 - 1279 Decimal)

# Symbologies

You can program the scanner to perform various functions or activate different features.

This section describes symbology features and provides programming barcodes for selecting these features.

The scanner ships with the settings shown in the [Symbology Parameter Defaults](#). If the default values suit requirements, programming is not necessary.

## Symbology Parameter Defaults

**Table 16** Parameter Default Table

Parameter	Parameter Number	SSI Number	Parameter Default
<b>UPC/EAN/JAN</b>			
UPC-A	1	01h	Enable
UPC-E	2	02h	Enable
UPC-E1	12	0Ch	Disable
EAN-8/JAN-8	4	04h	Enable
EAN-13/JAN-13	3	03h	Enable
Bookland EAN	83	53h	Disable
Bookland ISBN Format	576	F1h 40h	ISBN-10
ISSN EAN	617	F1h 69h	Disable
User-Programmable Supplementals	579	F1h 43h	0
UPC/EAN/JAN Supplemental Redundancy	80	50h	10
UPC/EAN/JAN Supplemental AIM ID Format	672	F1h A0h	Combined AIM ID, 1 transmission
Linear UPC/EAN	68	44h	Disable
Transmit UPC-A Check Digit	40	28h	Enable

## Symbologies

**Table 16** Parameter Default Table (Continued)

Parameter	Parameter Number	SSI Number	Parameter Default
Transmit UPC-E Check Digit	41	29h	Enable
Transmit UPC-E1 Check Digit	42	2Ah	Enable
UPC-A Preamble	34	22h	System Character
UPC-E Preamble	35	23h	System Character
UPC-E1 Preamble	36	24h	System Character
Convert UPC-E to UPC-A	37	25h	Disable
Convert UPC-E1 to UPC-A	38	26h	Disable
EAN/JAN Zero Extend	39	27h	Disable
Coupon Report	730	F1h DAh	New Coupon
UPC Reduced Quiet Zone	1289	F8h 05h 09h	Disable
Decode UPC/EAN/JAN Supplementals	16	10h	Ignore UPC/EAN/JAN Supplementals
<b>Code 128</b>			
Code 128	8	08h	Enable
Set Lengths for Code 128	209	D1h	All Lengths
GS1-128 (formerly UCC/EAN-128)	14	0Eh	Enable
ISBT 128	84	54h	Enable
ISBT Concatenation	577	F1h 41h	Disable ISBT Concatenation
Check ISBT Table	578	F1h42h	1
ISBT Concatenation Redundancy	223	DFh	10
Code 128 FNC4	1254	F8h 04h E6h	Honor
Code 128 Reduced Quiet Zone	1208	F8h 04h B8h	Disable
<b>Code 39</b>			
Code 39	0	00h	Enable
Convert Code 39 to Code 32	86	56h	Disable
Code 32 Prefix	231	E7h	Disable
Set Lengths for Code 39	Minimum length: 18 Maximum length: 19	12h 13h	1 55

**Table 16** Parameter Default Table (Continued)

Parameter	Parameter Number	SSI Number	Parameter Default
Code 39 Check Digit Verification	48	30h	Disable
Transmit Code 39 Check Digit	43	2Bh	Disable
Code 39 Full ASCII Conversion	17	11h	Disable
Code 39 Reduced Quiet Zone	1209	F8h 04h B9h	Disable
Transmit Code 39 Start/ Stop Characters	1900	F8h 07h 6Ch	Disable
<b>Code 93</b>			
Code 93	9	09h	Enable
Set Lengths for Code 93	Minimum length: 26 Maximum length: 27	1Ah 1Bh	1 55
<b>Interleaved 2 of 5 (ITF)</b>			
Set Lengths for Interleaved 2 of 5	Minimum Length: 22 Maximum Length: 23	16h 17h	6 55
Interleaved 2 of 5 (I 2 of 5)	6	06h	Enable
Interleaved 2 of 5 (I 2 of 5) Check Digit Verification	49	31h	Disable
Transmit I 2 of 5 Check Digit	44	2Ch	Disable
Convert I 2 Of 5 To Ean13	82	52h	Disable
Febraban	1750	F8h 06h D6h	Disable
Interleaved 2 of 5 (I 2 of 5) Security Level	1121	F8h 04h 61h	Level 1
Interleaved 2 of 5 (I 2 of 5) Reduced Quiet Zone	1210	F8h 04h BAh	Disable
<b>Discrete 2 of 5</b>			
Discrete 2 of 5 (D 2 of 5)	5	05h	Disable
Set Lengths for Discrete 2 of 5	20	14h	All Lengths
<b>Codabar (NW - 7)</b>			
Codabar (NW - 7)	7	07h	Enable

**Table 16** Parameter Default Table (Continued)

Parameter	Parameter Number	SSI Number	Parameter Default
Set Lengths for Codabar	Minimum Length: 24 Maximum Length: 25	18h 19h	4 55
CLSI Editing	54	36h	Disable
NOTIS Editing	55	37h	Disable
Codabar Security Level	1776	F8h 06h F0h	Codabar Security Level 1
Codabar Upper or Lower Case Start/Stop Characters	855	F2h 57h	Upper Case
Codabar Mod 16 Check Digit Verification	1784	F8h 06h F8h	Disable
Transmit Codabar Check Digit	704	F1h C0h	Disable
<b>MSI</b>			
MSI	11	0Bh	Disable
Set Lengths for MSI	Minimum Length: 30 Maximum Length: 31	1Eh 1fh	4 55
MSI Check Digits	50	32h	One Check Digits
Transmit MSI Check Digit(s)	46	2Eh	Disable
MSI Check Digit Algorithm	51	33h	MOD 10/MOD 10
MSI Reduced Quiet Zone	1392	F8h 05h 70h	Disable
<b>2 of 5</b>			
Chinese 2 of 5	408	F0h 98h	Disable
Korean 3 of 5	581	F1h 45h	Disable
Inverse 1D	586	F1h 4Ah	Regular
<b>GS1 DataBar</b>			
GS1 DataBar Omnidirectional (formerly GS1 DataBar-14)	338	F0h 52h	Enable
GS1 DataBar Limited	339	F0h 53h	Enable
GS1 DataBar Expanded	340	F0h 54h	Enable
Convert GS1 DataBar to UPC/EAN/JAN	397	F0h 8Dh	Disable
GS1 DataBar Security Level	1706	F8h 06h AAh	Level 1

**Table 16** Parameter Default Table (Continued)

Parameter	Parameter Number	SSI Number	Parameter Default
GS1 DataBar Limited Margin Check	728	F1h D8h	Level 3
GS1 Digital Link	2373	F8h 09h 45h	Disable
GS1 Digital Link Mode	2374	F8h 09h 46h	Mode 1
GS1 Digital Link Prioritization Timeout	2491	F8h 09h BBh	200
<b>Symbology-Specific Security Features</b>			
Redundancy Level	78	4Eh	Level 1
Security Level	77	4Dh	Level 1
1D Quiet Zone Level	1288	F8h 05h 08h	Level 1
Intercharacter Gap Size	381	F0h 7Dh	Normal
<b>2D Symbologies</b>			
PDF417	15	0Fh	Enable
MicroPDF417	227	E3h	Disable
Code 128 Emulation	123	7Bh	Disable
Data Matrix	292	F0h 24h	Enable
GS1 Data Matrix	1336	F8h 05h 38h	Disable
Data Matrix Inverse	588	F1h 4Ch	Inverse Autodetect
Decode Data Matrix Mirror Images	537	F1h19h	Auto
QR Code	293	F0h25h	Enable
Weblink QR	1947	F8h 07h 9Bh	Enable
GS1 QR	1343	F8h05h3Fh	Enable
MicroQR	573	F1h 3Dh	Enable
Linked QR Mode	1847	F8h07h37h	Linked QR Only
Aztec	574	F1h 3Eh	Enable
Aztec Inverse	589	F1h 4Dh	Inverse Autodetect
Han Xin	1167	F8h 04h 8Fh	Disable
Han Xin Inverse	1168	F8h 04h 90h	Regular
Grid Matrix	1718	F8h 06h B6h	Disable
Grid Matrix Inverse	1719	F8h 06h B7h	Regular Only
Grid Matrix Mirrored	1736	F8h 06h C8h	Regular Only
DotCode	1906	F8h 07h 72h	Disable
DotCode Prioritize	1937	F8h 07h 91h	Enable
DotCode Inverse	1907	F8h 07h 73h	Inverse Autodetect

**Table 16** Parameter Default Table (Continued)

Parameter	Parameter Number	SSI Number	Parameter Default
DotCode Mirrored	1908	F8h 07h 74h	Auto
DotCode Erasure Limit	2063	F8h 08h 0Fh	10

## Enable/Disable All Code Types

Scan one of the following barcodes to enable or disable the scanner's ability to decode all barcode types.

- Disable All Code Types - Disable all code types. This is useful when enabling only a few code types.
- Enable All Code Types - Enable all code types. This is useful if you need to disable only a few code types.



Disable All Code Types

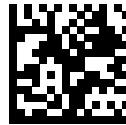

Enable All Code Types

## Default Parameters

Scan one of the following barcodes to reset the scanner to its default settings.

- Restore Defaults resets all default parameters as follows:
  - If you configured custom default parameter values via the Write to Custom Defaults barcode, scanning the Restore Defaults barcode restores these custom values.
  - If you did not configure custom default parameter values, scanning the Restore Defaults barcode restores the factory default values. Default values are available at the beginning of each section.
- Set Factory Defaults clears all custom default values and sets the factory default values. Default values are available at the beginning of each section.



Restore Defaults



Set Factory Defaults



Write to Custom Defaults

## Preferred Symbol

Preferred Symbol is a barcode prioritization technique that enables favored decoding of high-priority barcode(s). The Preferred Symbol is the only barcode that is decoded and output within the preset Preferred Symbol Timeout. During this time, the scanner attempts to decode the prioritized barcode and reports only this barcode.

For more information, refer to the Multicode Data Formatting and Preferred Symbol User Guide, p/n MN-002895-xx.

To program Preferred Symbol via 123Scan, select **123Scan > Configuration Wizard > Symbologies** screen, and then select **Preferred Symbol** from the drop-down menu. Preferred Symbol programming is saved in the 123Scan configuration file.

**Figure 10** Preferred Symbol Programming Options

Preferred Symbol ▾

Preferred Symbol [What is this?](#)

⤴ Options

**Prioritized symbologies**

Preferred Symbol Options  [Edit](#)

**Identify exact bar code**

Preferred symbol criteria [View / Edit](#)

Prioritization time (ms)  [What is this?](#)

## UPC-A

### Parameter # 1 (SSI #01h)

This parameter enables or disables the scanner to decode UPC-A barcodes.

- \*Enabled - enables UPC-A decoding.
- Disabled - disables UPC-A decoding.



\*Enable UPC-A (1)



Disable UPC-A (0)

## UPC-E

### Parameter # 2 (SSI # 02h)

This parameter enables UPC-E.

- \*Enabled - this sets UPC-E to use.
- Disabled - UPC-E is no longer in use.



\*Enable UPC-E (1)



Disable UPC-E (0)

## UPC-E1

### Parameter # 12 (SSI # 0Ch)

This parameter enables UPC-E1.

- Enabled - This sets UPC-E1 to use.
- Disabled - UPC-E1 is no longer in use.



**NOTE:** UPC-E1 is not a UCC (Uniform Code Council) approved symbology.



Enable UPC-E1 (1)



\*Disable UPC-E1 (0)

## EAN-8/JAN-8

### Parameter # 4 (SSI # 04h)

This parameter enables EAN-8/JAN-8.

- Enabled - Sets EAN-8/JAN-8 for use.
- Disabled - EAN-8/JAN-8 is no longer in use.



\*Enable EAN-8/JAN-8 (1)



Disable EAN-8/JAN-8 (0)

## EAN-13/JAN-13

### Parameter # 3 (SSI # 03h)

This parameter enables EAN-13/JAN-13.

- Enabled - Sets EAN-13/JAN-13 for use.
- Disabled - EAN-13/JAN-13 is no longer in use.



\*Enable EAN-13/JAN-13 (1)



Disable EAN-13/JAN-13 (0)

## Bookland EAN

### Parameter # 83 (SSI # 53h)

This parameter enables Bookland EAN.

- Enabled - This sets Bookland EAN for use.
- Disabled - Bookland EAN is no longer in use.



**NOTE:** If you enable Bookland EAN, select a [Bookland ISBN Format](#). Also set [Decode UPC/EAN/JAN Supplementals](#) to either Decode UPC/EAN/JAN with Supplementals Only, Autodiscriminate UPC/EAN/JAN With Supplementals, or Enable 978/979 Supplemental Mode.



Enable Bookland EAN (1)



\*Disable Bookland EAN (0)

## Bookland ISBN Format

### Parameter # 576 (SSI # F1h 40h)

If Bookland EAN is enabled, this parameter allows you to choose a format for Bookland data.

- \*Bookland ISBN-10 - The scanner reports Bookland data starting with 978 in traditional 10-digit format with the special Bookland check digit for backward-compatibility. Data starting with 979 is not considered Bookland in this mode.
- Bookland ISBN-13 - The scanner reports Bookland data (starting with either 978 or 979) as EAN-13 in 13-digit format to meet the 2007 ISBN-13 protocol.



**NOTE:** For Bookland EAN to function properly, first enable [Bookland EAN](#) and then set [Decode UPC/EAN/JAN Supplementals](#) to either Decode UPC/EAN/JAN with Supplementals Only, Autodiscriminate UPC/EAN/JAN With Supplementals, or Enable 978/979 Supplemental Mode.



\*Bookland ISBN-10 (0)



Bookland ISBN-13 (1)

## ISSN EAN

### Parameter # 617 (SSI # F1h 69h)

This parameter enables ISSN EAN.

- Enabled - Sets ISSN EAN for use.
- \*Disabled - ISSN EAN is no longer in use.



Enable ISSN EAN (1)



\*Disable ISSN EAN (0)

## User-Programmable Supplementals

**Parameter # 579 (SSI # F4h F1h 43h)**

**Parameter # 580 (SSI # F4h F1h 44h)**

If you selected a Supplemental User-Programmable option, this parameter allows you to set two 3-digit prefixes.

- User-Programmable Supplemental 1 - Sets the first 3-digit prefix. See [Numeric Barcodes](#).
- User-Programmable Supplemental 2 - Sets a 2nd 3-digit prefix, if necessary. See [Numeric Barcodes](#).



User-Programmable Supplemental 1



User-Programmable Supplemental 2

## UPC/EAN/JAN Supplemental Redundancy

**Parameter # 80 (SSI # 50h)**

If you selected Autodiscriminate UPC/EAN/JAN with Supplementals, this option sets the number of times to decode a symbol without supplementals before transmission. You can enable audio feedback during a reconnect attempt.

The range is from 2-30. Five or above is recommended when decoding a mix of UPC/EAN/JAN symbols with and without supplementals. The default is ten.

To set a redundancy value, scan the following barcode, and then scan two barcodes from [Numeric Barcodes](#). Enter a leading zero for single digit numbers. To correct an error or change a selection, scan [Cancel](#).



UPC/EAN/JAN Supplemental Redundancy

## UPC/EAN/JAN Supplemental AIM ID Format

### Parameter # 672 (SSI # F1h A0h)

If Transmit Code ID Character is set to **AIM Code ID Character**, select an output format when reporting UPC/EAN/JAN barcodes with supplementals.

- Separate - Transmit UPC/EAN/JAN with supplementals with separate AIM IDs but one transmission, for example,

```
]E<0 or 4><data>]E<1 or 2>[supplemental data]
```

- Combined - Transmit UPC/EAN/JAN with supplementals with one AIM ID and one transmission. For example, see below.

```
]E3<data+supplemental data>
```

- Separate Transmissions - Transmit UPC/EAN/JAN with supplementals with separate AIM IDs and separate transmissions, for example,

```
]E<0 or 4><data>  
]E<1 or 2>[supplemental data]
```



Separate (0)



\*Combined (1)



Separate Transmissions (2)

## Linear UPC/EAN

### Parameter # 68 (SSI # 44h)

When enabled, a UPC/EAN barcode is only decoded and transmitted when both the left and right blocks are successfully decoded within one image.

When disabled, the left and right blocks can be decoded in different images and transmitted together.

This parameter applies to code types containing two adjacent blocks (such as UPC-A, EAN-8, and EAN-13).

- Enabled - Requires both the left and right blocks to be decoded successfully in one image.
- Disabled - The left and right blocks can be decoded in different images.



**NOTE:** This is recommended when barcodes are in proximity to each other.



Enable Linear UPC/EAN (1)



\*Disable Linear UPC/EAN (0)

## Transmit UPC-A Check Digit

### Parameter # 40 (SSI # 28h)

This parameter transmits data with or without the UPC-A check digit.

The check digit is the last character of the symbol used to verify the integrity of the data. It is always verified to guarantee the integrity of the data.

- \*Transmit UPC-A Check Digit - Transmits the data with the UPC-A check digit.
- Do Not Transmit UPC-A Check Digit - Transmits the data without the UPC-A check digit.



\*Transmit UPC-A Check Digit (1)



Do Not Transmit UPC-A Check Digit (0)

## Transmit UPC-E Check Digit

### Parameter # 41 (SSI # 29h)

This parameter transmits data with or without the UPC-E check digit.

The check digit is the last character of the symbol used to verify the integrity of the data. It is always verified to guarantee the integrity of the data.

- \*Transmit UPC-E Check Digit - transmits the data with the UPC-E check digit.
- Do Not Transmit UPC-E Check Digit - transmits the data without the UPC-E check digit.



\*Transmit UPC-E Check Digit (1)



Do Not Transmit UPC-E Check Digit (0)

## Transmit UPC-E1 Check Digit

### Parameter # 42 (SSI # 2Ah)

This parameter transmits data with or without the UPC-E1 check digit.

The check digit is the last character of the symbol used to verify the integrity of the data. It is always verified to guarantee the integrity of the data.

- \*Transmit UPC-E1 Check Digit - Transmits the data with the UPC-E1 check digit.
- Do Not Transmit UPC-E1 Check Digit - Transmits the data without the UPC-E1 check digit.



\*Transmit UPC-E1 Check Digit (1)



Do Not Transmit UPC-E1 Check Digit (0)

## UPC-A Preamble

### Parameter # 34 (SSI # 22h)

Preamble characters are part of the UPC symbol, and include Country Code and System Character.

Select the appropriate option for transmitting a UPC-A preamble to match the host system:

- Transmit System Character only
- Transmit System Character and Country Code ("0" for USA)
- Transmit no preamble.



No Preamble (<DATA>) (0)



\*System Character (<SYSTEM CHARACTER>  
<DATA>) (1)



System Character & Country Code (< COUNTRY  
CODE> <SYSTEM CHARACTER> <DATA>) (2)

## UPC-E Preamble

### Parameter # 35 (SSI # 23h)

Preamble characters are part of the UPC symbol, and include Country Code and System Character.

Select the appropriate option for transmitting a UPC-E preamble to match the host system:

- Transmit System Character only
- Transmit System Character and Country Code ("0" for USA)
- Transmit no preamble.



No Preamble (<DATA>) (0)

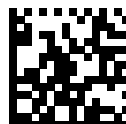

\*System Character (<SYSTEM CHARACTER>  
<DATA>) (1)



System Character & Country Code (< COUNTRY CODE> <SYSTEM CHARACTER> <DATA>) (2)

## UPC-E1 Preamble

### Parameter # 36 (SSI # 24h)

Preamble characters are part of the UPC symbol, and include Country Code and System Character.

Select the appropriate option for transmitting a UPC-E1 preamble to match the host system:

- Transmit System Character only
- Transmit System Character and Country Code (“0” for USA)
- Transmit no preamble.



No Preamble (<DATA>) (0)



\*System Character (<SYSTEM CHARACTER> <DATA>) (1)



System Character & Country Code (< COUNTRY CODE> <SYSTEM CHARACTER> <DATA>) (2)

## Convert UPC-E to UPC-A

### Parameter # 37 (SSI # 25h)

This parameter converts UPC-E (zero suppressed) decoded data to UPC-A format before transmission.

After conversion, the data follows UPC-A format and is affected by UPC-A programming selections (such as, Preamble, Check Digit).

- \*Enabled - Converts UPC-E decoded data to UPC-A format.
- Disabled - Transmits UPC-E decoded data without conversion to UPC-A.



Convert UPC-E to UPC-A (Enable) (1)



\*Do Not Convert UPC-E to UPC-A (Disable) (0)

## Convert UPC-E1 to UPC-A

### Parameter # 38 (SSI # 26h)

This parameter converts UPC-E1 (zero suppressed) decoded data to UPC-A format before transmission.

After conversion, the data follows UPC-A format and is affected by UPC-A programming selections (for example, Preamble, Check Digit).

- Enabled - converts UPC-E1 decoded data to UPC-A format.
- Disabled - transmits UPC-E1 decoded data without conversion to UPC-A.



Convert UPC-E1 to UPC-A (Enable) (1)



Do Not Convert UPC-E1 to UPC-A (Disable) (0)

## EAN/JAN Zero Extend

### Parameter # 39 (SSI # 27h)

This parameter enables or disables decoded EAN-8 symbols to be compatible in length with EAN-13 symbols.

- Enabled - Adds five leading zeros to decoded EAN-8 symbols to make them compatible in length to EAN-13 symbols
- Disabled - Transmits EAN-8 symbols as-is, without adding zeroes.



Enable EAN/JAN Zero Extend (1)



\*Disable EAN/JAN Zero Extend (0)

## Coupon Report

### Parameter # 730 (SSI # F1h DAh)

This parameter selects the type of coupon format to support.

- Old Coupon Format - Support UPC-A/GS1-128 and EAN-13/GS1-128.
- New Coupon Format - An interim format to support UPC-A/GS1-DataBar and EAN-13/GS1-DataBar.
- Autodiscriminate Format - Support both Old Coupon Format and New Coupon Format.



Old Coupon Format (0)



\*New Coupon Format (1)



Autodiscriminate Coupon Format (2)

## UPC Reduced Quiet Zone

### Parameter # 1289 (SSI # F8h 05h 09h)

This parameter enables or disables decoding UPC barcodes with reduced quiet zones (the margins on either side of the barcode).

- Enabled - Enables decoding UPC barcodes with reduced quiet zones.
- \*Disabled - Disables decoding UPC barcodes with reduced quiet zones.



**NOTE:** If you select Enable, select a [1D Quiet Zone Level](#).

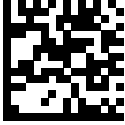

Enable UPC Reduced Quiet Zone (1)



\*Disable UPC Reduced Quiet Zone (0)

## Set Lengths for Code 128

### Parameter # 209 (SSI #D1h)

### Parameter # 210 (SSI #D2h)

This parameter sets lengths for Code 128 to any length, one or two discrete lengths, or lengths within a specific range.

The length of a code refers to the number of characters (for example, human-readable characters), including check digit(s) the code contains. The default is All Lengths.



**NOTE:** When setting lengths, enter a leading zero for single digit numbers.

- One Discrete Length - Decode only Code 128 symbols containing a selected length.
- Two Discrete Lengths - Decode only Code 128 symbols containing either of two lengths.
- Length Within Range - Decode Code 128 symbols with a length between 0 - 80
- Any Length - Decode Code 128 symbols containing any number of characters within the scanner's capability.

Select lengths using barcodes in [Numeric Barcodes](#). To correct an error or change the selection, scan [Cancel](#).

For example:

- To decode only Code 128 symbols with 14 characters, scan Code 128 - One Discrete Length, and then scan 1, 4.
- To decode only Code 128 symbols containing either 2 or 14 characters, scan Code 128 - Two Discrete Lengths, and then scan 0, 2, 1, 4.
- To decode Code 128 symbols containing between 4 and 12 characters, scan Code 128 - Length Within Range, and then scan 0, 4, 1, 2.



Code 128 - One Discrete Length



Code 128 - Two Discrete Lengths



Code 128 - Length Within Range (Default: 0 - 80 )

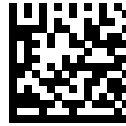

\*Code 128 - All Lengths

## Decode UPC/EAN/JAN Supplementals

### Parameter # 16 (SSI # 10h)

Supplementals are barcodes appended according to specific format conventions (for example, UPC A+2, UPC E+2, EAN 13+2).

The following options are available:

- Decode UPC/EAN/JAN with Supplementals Only - The scanner only decodes UPC/EAN/JAN symbols with supplemental characters, and ignores symbols without supplementals.
- Ignore UPC/EAN/JAN Supplementals - When presented with a UPC/EAN/JAN plus supplemental symbol, the scanner decodes UPC/EAN/JAN and ignores the supplemental characters.
- Autodiscriminate UPC/EAN/JAN with Supplementals - The scanner decodes UPC/EAN/JAN symbols with supplemental characters immediately. If the symbol does not have a supplemental, the scanner must decode the barcode the number of times set via [UPC/EAN/JAN Supplemental Redundancy](#) on page 140 before transmitting its data to confirm that there is no supplemental.
- Select one of the following Supplemental Mode options to immediately transmit EAN-13 barcodes starting with that prefix that have supplemental characters. If the symbol does not have a supplemental, the scanner must decode the barcode the number of times set via [UPC/EAN/JAN Supplemental](#)

[Redundancy](#) on page 140 before transmitting the data to confirm that there is no supplemental. The scanner transmits UPC/EAN/JAN barcodes that do not have that prefix immediately

- Enable 378/379 Supplemental Mode
- Enable 978/979 Supplemental Mode



**NOTE:** If you select 978/979 Supplemental Mode and are scanning Bookland EAN barcodes, see [Bookland EAN](#) on page 138 to enable Bookland EAN, and select a format using [Bookland ISBN Format](#) on page 139.

- Enable 977 Supplemental Mode
- Enable 414/419/434/439 Supplemental Mode
- Enable 491 Supplemental Mode
- Enable Smart Supplemental Mode - This applies to EAN-13 barcodes starting with any prefix listed previously.
- Supplemental User-Programmable Type 1 - This applies to EAN-13 barcodes starting with a 3-digit user-defined prefix. Set this using [User-Programmable Supplementals](#).
- Supplemental User-Programmable Type 1 and 2 - This applies to EAN-13 barcodes starting with either of two 3-digit user-defined prefixes. Set the prefixes using [User-Programmable Supplementals](#).
- Smart Supplemental Plus User-Programmable 1 - This applies to EAN-13 barcodes starting with any prefix listed previously or the prefix set using [User-Programmable Supplementals](#).
- Smart Supplemental Plus User-Programmable 1 and 2 - This applies to EAN-13 barcodes starting with any prefix listed previously or one of the two user-defined prefixes set using [User-Programmable Supplementals](#).



**NOTE:** To minimize the risk of invalid data transmission, select either to decode or ignore supplemental characters.



Decode UPC/EAN/JAN With Supplementals Only  
(1)



\*Ignore UPC/EAN/JAN Supplementals (0)



Autodiscriminate UPC/EAN/JAN with  
Supplementals (2)

## Symbologies



Enable 378/379 Supplemental Mode (4)



Enable 978/979 Supplemental Mode (5)

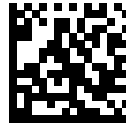

Enable 977 Supplemental Mode (7)



Enable 414/419/434/439 Supplemental Mode (6)



Enable 491 Supplemental Mode (8)



Enable Smart Supplemental Mode (3)

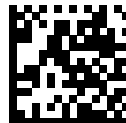

Supplemental User-Programmable Type 1 (9)



Supplemental User-Programmable Type 1 and 2 (10)



Smart Supplemental Plus User-Programmable 1 (11)



Smart Supplemental Plus User-Programmable 1 and 2 (12)

## Code 128

### Parameter # 8 (SSI #08h)

You can enable or disable Code 128.

- \*Enabled - Enables Code 128.
- Disabled - Disables Code 128.



\*Enable Code 128 (1)



Disable Code 128 (0)

## GS1-128 (formerly UCC/EAN-128)

### Parameter # 14 (SSI #0Eh)

You can enable or disable GS1-128.

- \*Enabled - Enables GS1-128.
- Disabled - Disables GS1-128.



\*Enable GS1-128 (1)



Disable GS1-128 (0)

## ISBT 128

### Parameter # 84 (SSI #54h)

You can enable or disable ISBT 128.

- \*Enabled - enables ISBT 128.
- Disabled - disables ISBT 128.

ISBT 128 is a variant of Code 128 used in the blood bank industry.



\*Enable ISBT 128 (1)

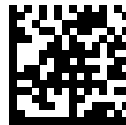

Disable ISBT 128 (0)

## ISBT Concatenation

### Parameter # 577 (SSI #F1h 41h)

This parameter enables and disables ISBT concatenation.

Select an option for concatenating pairs of ISBT code types:

- Enable ISBT Concatenation - There must be two ISBT codes in order for the scanner to decode and perform concatenation. The scanner does not decode single ISBT symbols.
- Disable ISBT Concatenation - The scanner does not concatenate pairs of ISBT codes it encounters.
- Autodiscriminate ISBT Concatenation - The scanner decodes and concatenates pairs of ISBT codes immediately. If only a single ISBT symbol is present, the scanner must decode the symbol the number of times set via [ISBT Concatenation Redundancy](#) before transmitting its data to confirm that there is no additional ISBT symbol.



**NOTE:** For ISBT AutoDetect to operate as expected, both barcodes must be in the field of view simultaneously. This may be difficult to achieve in presentation mode.



**NOTE:** When enabling ISBT Concatenation or Autodiscriminate ISBT Concatenation set Code 128 Security Level to Level 2.



Enable ISBT Concatenation (1)



Disable ISBT Concatenation (0)



Autodiscriminate ISBT Concatenation (2)

## Check ISBT Table

### Parameter # 578 (SSI #F1h 42h)

This parameter enables or disables the Check ISBT Table to concatenate only those pairs found in this table. Other types of ISBT codes are not concatenated.

- \*Enabled - enables the Check ISBT Table to concatenate only those pairs found in this table.
- Disabled - disables the Check ISBT Table to concatenate only those pairs found in this table.

The ISBT specification includes a table that lists several types of ISBT barcodes that are commonly used in pairs.



\*Enable Check ISBT Table (1)



Disable Check ISBT Table (0)

## ISBT Concatenation Redundancy

### Parameter # 223 (SSI #DFh)

This parameter sets the number of times the scanner must decode an ISBT symbol before determining that there is no additional symbol.

This parameter applies if you set ISBT Concatenation to Autodiscriminate.

Scan the following barcode, and then scan barcodes in [Numeric Barcodes](#) to set a value between 2 and 20. Enter a leading zero for single-digit numbers. To correct an error or change a selection, scan [Cancel](#). The default is 10.



ISBT Concatenation Redundancy

## Code 128 <FNC4>

### Parameter # 1254 (SSI #F8h 04h E6h)

This parameter processes the Code 128 <FNC4> character, and either ignores (removes) the character or honors (does not remove) the character.

- \*Honor Code 128 <FNC4> - The <FNC4> character is processed normally, per Code 128 standard.
- Ignore Code 128 <FNC4> - Strips the <FNC4> character from the decode data. The remaining characters are sent to the host unchanged.



\*Honor Code 128 <FNC4> (0)



Ignore Code 128 <FNC4> (1)

## Code 128 Reduced Quiet Zone

### Parameter # 1208 (SSI #F8h 04h B8h)

This parameter enables or disables decoding Code 128 with reduced quiet zones (the margins on either side of the barcode).

If you select Enable, select a [1D Quiet Zone Level](#).

- Enabled - enables Code 128 with reduced Quiet Zones.
- \*Disabled - disables Code 128 with reduced Quiet Zones.



Enable Code 128 Reduced Quiet Zone (1)



\*Disable Code 128 Reduced Quiet Zone (0)

## Code 39

### Parameter # 0 (SSI #00h)

This parameter enables or disables the scanner to decode Code 39 barcodes.

- \*Enabled - Enables Code 39.
- Disabled - Disables Code 39.



\*Enable Code 39 (1)



Disable Code 39 (0)

## Convert Code 39 to Code 32

### Parameter # 86 (SSI #5h)

This parameter enables or disables converting Code 39 to Code 32.

Code 32 is a variant of Code 39 used by the Italian pharmaceutical industry.



**NOTE:** Code 39 must be enabled for this parameter to function.

- Enabled - enables Convert Code 39 to Code 32.
- \*Disabled - disables Convert Code 39 to Code 32.



Enable Convert Code 39 to Code 32 (1)



\*Disable Convert Code 39 to Code 32 (0)

## Code 32 Prefix

### Parameter # 231 (SSI #E7h)

This parameter enables or disables adding the prefix character “A” to all Code 32 barcodes.

- Enabled - enables Code 32 Prefix.
- \*Disabled - disables Code 32 Prefix.



**NOTE:** [Convert Code 39 to 32](#) must be enabled for this parameter to function.



Enable Code 32 Prefix (1)



\*Disable Code 32 Prefix (0)

## Set Lengths for Code 39

### L1 Parameter # 18 (SSI #12h)

### L2 Parameter # 19 (SSI #13h)

This parameter sets the lengths for Code 39.

The length of a code refers to the number of characters (for example, human readable characters), including check digit(s) the code contains.

The options are:

- Any length
- One or two discrete lengths
- Lengths within a specific range

If Code 39 Full ASCII is enabled, Length Within Range or Any Length are the preferred options. The default behavior is Length Within Range, with a default value of 1 - 55.



**NOTE:** When setting the lengths, enter a leading zero for single digit numbers.

- One Discrete Length - Decode only Code 39 symbols containing a selected length.
- Two Discrete Lengths - Decode only Code 39 symbols containing either of two lengths.
- Length Within Range - Decode Code 39 symbols with a specific length range.
- Any Length - Decode Code 39 symbols containing any number of characters within the scanner’s capability.

Select lengths using barcodes in [Numeric Barcodes](#). To correct an error or change the selection, scan [Cancel](#).

For example:

- To decode only Code 39 symbols with 14 characters, scan Code 39 - One Discrete Length, and then scan 1, 4.
- To decode only Code 39 symbols containing either 2 or 14 characters, scan Code 39 - Two Discrete Lengths, and then scan 0, 2, 1, 4.
- To decode Code 39 symbols containing between 4 and 12 characters, scan Code 39 - Length Within Range, and then scan 0, 4, 1, 2.



Code 39 - One Discrete Length



Code 39 - Two Discrete Lengths



\*Code 39 - Length Within Range (Default: Length Within Range)



Code 39 - Any Length

## Code 39 Check Digit Verification

### Parameter # 48 (SSI #30h)

This parameter checks the integrity of all Code 39 symbols to verify that the data complies with specified check digit algorithm.

Only Code 39 symbols which include a modulo 43 check digit are decoded. Enable this feature if the Code 39 symbols contain a Modulo 43 check digit.

- Enabled - enables Code 39 Check Digit.
- \*Disabled - disables Code 39 Check Digit.



Enable Code 39 Check Digit (1)



\*Disable Code 39 Check Digit (0)

## Transmit Code 39 Check Digit

### Parameter # 43 (SSI #2Bh)

This parameter transmits Code 39 data with or without the check digit.

- Enabled - enables Transmit Code 39 Check Digit.
- \*Disabled - disables Transmit Code 39 Check Digit.



**NOTE:** [Code 39 Check Digit Verification](#) must be enabled for this parameter to function.



Transmit Code 39 Check Digit (Enable) (1)

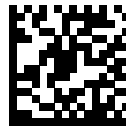

\*Do Not Transmit Code 39 Check Digit (Disable) (0)

## Code 39 Full ASCII Conversion

### Parameter # 17 (SSI #11h)

This parameter enables or disables Code 39 Full ASCII.

Code 39 Full ASCII is a variant of Code 39 which pairs characters to encode the full ASCII character set.

- Enabled - enables Code 39 Full ASCII.
- \*Disabled - disables Code 39 Full ASCII.



**NOTE:** Code 39 Full ASCII to Full ASCII Correlation is host-dependent, and is therefore described in the ASCII character set table for the appropriate interface. See [ASCII Character Sets](#).



Enable Code 39 Full ASCII (1)



\*Disable Code 39 Full ASCII (0)

## Set Lengths for Code 93

### Parameter # 26 (SSI #1Ah)

### Parameter # 27 (SSI #1Bh)

This parameter sets the lengths for Code 93 to any length, one or two discrete lengths, or lengths within a specific range.

The length of a code refers to the number of characters (for example, human-readable characters), including check digit(s) the code contains.

The options are:

- Any length
- One or two discrete lengths
- Lengths within a specific range

The default behavior is 1 to 55, with a default value of 0 to 80 digits.



**NOTE:** When setting the lengths, enter a leading zero for single-digit numbers.

- One Discrete Length - Decode only Code 93 symbols containing a selected length.
- Two Discrete Lengths - Decode only Code 93 symbols containing either of two lengths.
- Length Within Range - Decode Code 93 symbols with a specific length range.
- Any Length - Decode Code 93 symbols containing any number of characters within the scanner's capability.

Select lengths using barcodes in [Numeric Barcodes](#). To correct an error or change the selection, scan [Cancel](#).

For example:

- To decode only Code 93 symbols with 14 characters, scan Code 93 - One Discrete Length, and then scan 1, 4.
- To decode only Code 93 symbols containing either 2 or 14 characters, scan Code 93 - Two Discrete Lengths, and then scan 0, 2, 1, 4.
- To decode Code 93 symbols containing between 4 and 12 characters, scan Code 93 - Length Within Range, and then scan 0, 4, 1, 2.



Code 93 - One Discrete Length



Code 93 - Two Discrete Lengths



\*Code 93 - Length Within Range (Default: 1 to 55 )



Code 93 - Any Length

## Code 39 Reduced Quiet Zone

### Parameter # 1209 (SSI #F8h 04h B9h)

This parameter enables or disables decoding Code 39 with reduced quiet zones. Quiet zones are the margins on either side of the barcode.

If you select Enable, select a [1D Quiet Zone Level](#).

- Enabled - enables Code 39 with reduced Quiet Zones.
- \*Disabled - disables Code 39 with reduced Quiet Zones.



Enable Code 39 Reduced Quiet Zone (1)



\*Disable Code 39 Reduced Quiet Zone (0)

## Transmit Code 39 Start/Stop Characters

### Parameter # 1900 (SSI # F8 07 6Ch)

This parameter selects whether to transmit Code 39 start/stop characters.



\*Disable Transmit Code 39 Start/Stop Characters  
(0)



Enable Transmit Code 39 Start/Stop Characters (1)

## Code 93

### Parameter # 9 (SSI #09h)

This parameter enables or disables the scanner to decode Code 93 barcodes.

- \*Enabled - enables Code 93 decoding.
- Disabled - disables Code 93 decoding.



\*Enable Code 93 (1)

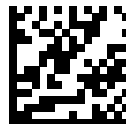

Disable Code 93 (0)

## Set Lengths for Interleaved 2 of 5 (I 2 of 5)

### L1 Parameter # 22 (SSI #16h)

### L2 Parameter # 23 (SSI #17h)

This parameter sets the length for I 2 of 5.

The length of a code refers to the number of characters (for example, human-readable characters), including check digit(s) the code contains.

The options are:

- Any length
- One or two discrete lengths
- Lengths within a specific range

The default behavior is Length Within Range, with a default value of 6 to 55 .



**NOTE:** When setting the lengths, enter a leading zero for single digit numbers.

- One Discrete Length - Decode only 1 2 of 5 symbols containing a selected length.
- Two Discrete Lengths - Decode only 1 2 of 5 symbols containing either of two lengths.
- Length Within Range - Decode 1 2 of 5 symbols with a specific length range.
- Any Length - Decode 1 2 of 5 symbols containing any number of characters within the scanner's capability.



**NOTE:** Due to the construction of the 1 2 of 5 symbology, it is possible for a scan line covering only a portion of the code to transmit as a complete scan, yielding less data than is encoded in the barcode. To prevent this, select specific lengths (1 2 of 5 - One Discrete Length, Two Discrete Lengths) for 1 2 of 5 applications, or increase the [Security Level](#).

Select barcode length in [Numeric Barcodes](#). To correct an error or change the selection, scan [Cancel](#).

For example:

- To decode only 1 2 of 5 symbols with 14 characters, scan 1 2 of 5 - One Discrete Length, and then scan 1, 4.
- To decode only 1 2 of 5 symbols containing either 2 or 14 characters, scan 1 2 of 5 - Two Discrete Lengths, and then scan 0, 2, 1, 4.
- To decode 1 2 of 5 symbols containing between 4 and 12 characters, scan 1 2 of 5 - Length Within Range, and then scan 0, 4, 1, 2.



1 2 of 5 - One Discrete Length



1 2 of 5 - Two Discrete Lengths



\*1 2 of 5 - Length Within Range



1 2 of 5 - Any Length

## Interleaved 2 of 5 (I 2 of 5)

Parameter # 6 (SSI #06h)

This parameter enables or disables the scanner to decode I 2 of 5 barcodes.

- Enabled - enables I 2 of 5 decoding.
- Disabled - disables I 2 of 5 decoding.



\*Enable Interleaved 2 of 5 (1)



Disable Interleaved 2 of 5 (0)

## Interleaved 2 of 5 (I 2 of 5) Check Digit Verification

### Parameter # 49 (SSI #31h)

This parameter enables or disables checking the integrity of all I 2 of 5 symbols to verify the data complies with either the specified Uniform Symbology Specification (USS) or the Optical Product Code Council (OPCC) check digit algorithm.

- \*Disable - disables checking the integrity of all I 2 of 5 symbols to verify the data complies.
- USS Check Digit - enables checking the integrity of USS.
- OPCC Check Digit - enables checking the integrity of OPCC.



\*Disable (0)

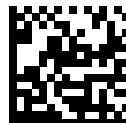

USS Check Digit (1)



OPCC Check Digit (2)

## Transmit I 2 of 5 Check Digit

### Parameter # 44 (SSI #2Ch)

This parameter enables or disables transmission of I 2 of 5 data with or without the check digit.

- Enabled - enables transmission of check digit.
- \*Disabled - disables transmission of check digit.



Transmit I 2 of 5 Check Digit (Enable) (1)



\*Do Not Transmit I 2 of 5 Check Digit (Disable) (0)

## Convert Interleaved 2 of 5 (I 2 of 5) to EAN-13

### Parameter # 82 (SSI #52h)

This parameter enables or disables converting 14-character I 2 of 5 codes to EAN-13, and then transmitting to the host as EAN-13.

- Enabled - enables converting 14-character I 2 of 5 codes to EAN-13.
- \*Disabled - disables converting 14-character I 2 of 5 codes to EAN-13.



**NOTE:** The I 2 of 5 code must be enabled, and the code must have a leading zero and a valid EAN-13 check digit.



Convert I 2 of 5 to EAN-13 (Enable) (1)

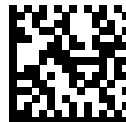

\*Do Not Convert I 2 of 5 to EAN-13 (Disable) (0)

## Febraban

### Parameter # 1750 (SSI #F8h 06h D6h)

This parameter enables or disables the I 2 of 5 internal check digit calculation and transmission.

Febraban is an Interleaved 2 of 5 (I 2 of 5) length 44 that requires inserting special check characters in the transmitted data stream.

- Enabled - enables internal check of digit calculation and transmission.
- \*Disabled - disables internal check of digit calculation and transmission.



**NOTE:** Recommendations for length settings:

- I 2 of 5 Length 1: Larger of the fixed length and the Febraban length (==44).
- I 2 of 5 Length 2: Smaller of the fixed length and the Febraban length (==44).

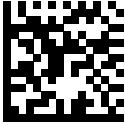

Enable Febraban (1)



\*Disable Febraban (0)

## Interleaved 2 of 5 (I 2 of 5) Security Level

### Parameter # 1121 (SSI #F8h 04h 61h)

This parameter sets the security level for I 2 of 5.

I 2 of 5 barcodes are vulnerable to misdecodes, particularly when I 2 of 5 Lengths is set to Any Length. The scanner offers four levels of decode security for I 2 of 5 barcodes. There is an inverse relationship between security and scanner aggressiveness. Increasing the level of security can reduce scanning aggressiveness, so select only the level of security necessary.

- I 2 of 5 Security Level 0: The scanner operates in its most aggressive state, while providing sufficient security in decoding most in-spec barcodes.
- I 2 of 5 Security Level 1: A barcode must be successfully read twice, and satisfy certain safety requirements before being decoded. This default setting eliminates most misdecodes.
- I 2 of 5 Security Level 2: This option applies greater barcode security requirements if Security Level 1 fails to eliminate misdecodes.
- I 2 of 5 Security Level 3: If you selected Security Level 2, and misdecodes still occur, select this security level. The highest safety requirements are applied. A barcode must be successfully read three times before being decoded.



**NOTE:** Selecting this option is an extreme measure against mis-decoding severely out-of-spec barcodes, and significantly impairs the decoding ability of the scanner. If this level of security is required, try to improve the quality of the barcodes.



I 2 of 5 Security Level 0 (0)



\*I 2 of 5 Security Level 1 (1)



I 2 of 5 Security Level 2 (2)



I 2 of 5 Security Level 3 (3)

## Set Lengths for Discrete 2 of 5 (D 2 of 5)

L1 Parameter # 20 (SSI #14h)

L2 Parameter # 21 (SSI #15h)

This parameter sets the lengths for D 2 of 5.

The length of a code refers to the number of characters (for example, human-readable characters), including check digit(s) the code contains.

The options are:

- Any length
- One or Two discrete lengths
- Lengths within a specific range

The default behavior is lengths within a specific range .



**NOTE:** When setting the lengths, enter a leading zero for single digit numbers.

Scan one of the following barcodes to select a length option:

- One Discrete Length - Decode only D 2 of 5 symbols containing a selected length.
- Two Discrete Lengths - Decode only D 2 of 5 symbols containing either of two lengths.
- \*Length Within Range - Decode D 2 of 5 symbols with a specific length range.
- Any Length - Decode D 2 of 5 symbols containing any number of characters within the scanner's capability.



**NOTE:** Due to the construction of the D 2 of 5 symbology, it is possible for a scan line covering only a portion of the code to transmit as a complete scan, yielding less data than is encoded in the barcode. To prevent this, select specific lengths (D 2 of 5 - One Discrete Length, Two Discrete Lengths) for D 2 of 5 applications.

Select lengths using barcodes in [Numeric Barcodes](#). To correct an error or change the selection, scan [Cancel](#).

For example:

- To decode only D 2 of 5 symbols with 14 characters, scan D 2 of 5 - One Discrete Length, and then scan 1, 4.
- To decode only D 2 of 5 symbols containing either 2 or 14 characters, scan D 2 of 5 - Two Discrete Lengths, and then scan 0, 2, 1, 4.
- To decode D 2 of 5 symbols containing between 4 and 12 characters, scan D 2 of 5 - Length Within Range, and then scan 0, 4, 1, 2.



D 2 of 5 - One Discrete Length

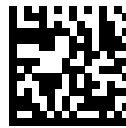

D 2 of 5 - Two Discrete Lengths

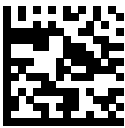

\*D 2 of 5 - Length Within Range

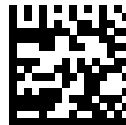

D 2 of 5 - Any Length

## Interleaved 2 of 5 (I 2 of 5) Reduced Quiet Zone

### Parameter # 1210 (SSI #F8h 04h B9h)

This parameter enables or disables decoding I 2 of 5 with reduced quiet zones (the margins on either side of the barcode).

If you select Enable, select a [1D Quiet Zone Level](#).

- Enabled - enables I 2 of 5 with reduced Quiet Zones.
- \*Disabled - disables I 2 of 5 with reduced Quiet Zones.

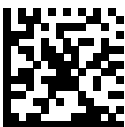

Enable I 2 of 5 Reduced Quiet Zone (1)



\*Disable I 2 of 5 Reduced Quiet Zone (0)

## Set Lengths for Codabar

L1 Parameter # 24 (SSI #18h)

L2 Parameter # 25 (SSI #19h)

This parameter sets lengths for Codabar.

The length of a code refers to the number of characters (for example, human-readable characters), including check digit(s) the code contains. Set lengths for Codabar to any length, one or two discrete lengths, or lengths within a specific range. The default behavior is 4 to 55, and the range is 0 to 60



**NOTE:** When setting lengths, enter a leading zero for single-digit numbers.

- One Discrete Length - Decode only Codabar symbols containing a selected length.
- Two Discrete Lengths - Decode only Codabar symbols containing either of two lengths.
- Length Within Range - Decode Codabar symbols with a specific length range.
- Any Length - Decode Codabar symbols containing any number of characters within the scanner's capability.

Select lengths using barcodes in [Numeric Barcodes](#). To correct an error or change the selection, scan [Cancel](#).

For example:

- To decode only Codabar symbols with 14 characters, scan Codabar - One Discrete Length, and then scan 1, 4.
- To decode only Codabar symbols containing either 2 or 14 characters, scan Codabar - Two Discrete Lengths, and then scan 0, 2, 1, 4.
- To decode Codabar symbols containing between 4 and 12 characters, scan Codabar - Length Within Range, and then scan 0, 4, 1, 2.



Codabar - One Discrete Length



Codabar - Two Discrete Lengths



\*Codabar - Length Within Range (Default: 4 to 55 )



Codabar - Any Length

## Discrete 2 of 5 (D 2 of 5)

### Parameter # 5 (SSI #05h)

This parameter enables or disables D 2 of 5.

- Enabled - enables D 2 of 5.
- \*Disabled - disables D 2 of 5.



Enable Discrete 2 of 5 (1)



\*Disable Discrete 2 of 5 (0)

## Codabar (NW - 7)

### Parameter # 7 (SSI #07h)

This parameter enables or disables the scanner to decode Codabar barcodes.

- \*Enabled - enables Codabar decoding.
- Disabled - disables Codabar decoding.



\*Enable Codabar (1)



Disable Codabar (0)

## CLSI Editing

### Parameter # 54 (SSI #36h)

This parameter enables or disables CLSI editing.

Select Enable CLSI Editing to strip the start and stop characters and insert a space after the first, fifth, and tenth characters of a 14-character Codabar symbol if the host system requires this data format.

- Enabled - enables CLSI editing.
- \*Disabled - disables CLSI editing.



**NOTE:** Symbol length does not include start and stop characters.



Enable CLSI Editing (1)

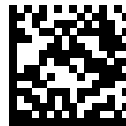

\*Disable CLSI Editing (0)

## NOTIS Editing

### Parameter # 55 (SSI #37h)

This parameter enables or disables NOTIS editing which strips the start and stop characters from a decoded Codabar symbol if the host system requires this data format.

- Enabled - enables NOTIS editing.
- \*Disabled - disables NOTIS editing.



Enable NOTIS Editing (1)



\*Disable NOTIS Editing (0)

## Codabar Security Level

### Parameter # 1776 (SSI #F8h 06h F0h)

This parameter sets the security level for Codabar 39.

The scanner offers four levels of decode security for Codabar barcodes. There is an inverse relationship between security and scanner aggressiveness. Increasing the level of security can reduce scanning aggressiveness, so select only the level of security necessary.

- Codabar Security Level 0: This setting allows the scanner to operate in its most aggressive state, while providing sufficient security in decoding most in-spec barcodes.
- Codabar Security Level 1: This default setting eliminates most misdecodes.
- Codabar Security Level 2: Select this option with greater barcode security requirements if Security Level 1 fails to eliminate misdecodes.
- Codabar Security Level 3: If you selected Security Level 2, and misdecodes still occur, select this security level to apply the highest safety requirements.



**NOTE:** Selecting this option is an extreme measure against mis-decoding severely out-of-spec barcodes, and significantly impairs the decoding ability of the scanner. If this level of security is required, try to improve the quality of the barcodes.



Codabar Security Level 0 (0)



\*Codabar Security Level 1 (1)



Codabar Security Level 2 (2)



Codabar Security Level 3 (3)

## Codabar Upper or Lower Case Start/Stop Characters

### Parameter # 855 (SSI #F2h 57h)

This parameter selects whether to transmit upper case or lower case Codabar start/stop characters.

- Lower Case (1) - enables lowercase start/stop characters.
- \*Upper Case (0) - enables upper case start/stop characters.



Lower Case (1)



\*Upper Case (0)

## Codabar Mod 16 Check Digit Verification

### Parameter # 1784 (SSI #F8h 06h F8h)

This parameter checks the Codabar Mod 16 check digit to verify that the data complies with the specified check digit algorithm.

- Enabled - enables check digit.
- \*Disabled - disables check digit.

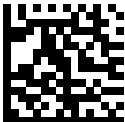

Enable Codabar Mod 16 Check digit (1)



\*Disable Codabar Mod 16 Check digit (0)

## Transmit Codabar Check Digit

### Parameter # 704 (SSI #F1h C0h)

This parameter selects whether or not to transmit the Codabar check digit(s).

- Enabled - enables check digit transmission.
- \*Disabled - disables check digit transmission.



Enable Codabar Check Digit Transmission (1)

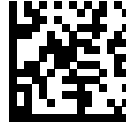

\*Disable Codabar Check Digit Transmission (0)

## MSI

### Parameter # 11 (SSI #0Bh)

This parameter enables or disables MSI.

- Enabled - enables MSI.
- \*Disabled - disables MSI.



Enable MSI (1)



\*Disable MSI (0)

## Set Lengths for MSI

### L1 Parameter # 30 (SSI #1Eh)

### L2 Parameter # 31 (SSI #1Fh)

This parameter sets the lengths for MSI.

The length of a code refers to the number of characters (for example, human-readable characters), including check digit(s) the code contains.

The options are:

- Any length
- One or two discrete lengths
- Lengths within a specific range

The default behavior is 4 to 55, with a default value of 0 to 55 .



**NOTE:** When setting the lengths, enter a leading zero for single-digit numbers.

Scan one of the following barcodes to select a length option:

- One Discrete Length - Decode only MSI symbols containing a selected length.
- Two Discrete Lengths - Decode only MSI symbols containing either of two lengths.
- Length Within Range - Decode MSI symbols with a specific length range.
- Any Length - Decode MSI symbols containing any number of characters within the scanner's capability.



**NOTE:** Due to the construction of the MSI symbology, it is possible for a scan line covering only a portion of the code to transmit as a complete scan, yielding less data than is encoded in the barcode. To prevent this, select specific lengths (MSI - One Discrete Length, Two Discrete Lengths) for MSI applications.

Select lengths using barcodes in [Numeric Barcodes](#). To correct an error or change the selection, scan [Cancel](#).

For example:

- To decode only MSI symbols with 14 characters, scan MSI - One Discrete Length, and then scan 1, 4.
- To decode only MSI symbols containing either 2 or 14 characters, scan MSI - Two Discrete Lengths, and then scan 0, 2, 1, 4.
- To decode MSI symbols containing between 4 and 12 characters, scan MSI - Length Within Range, and then scan 0, 4, 1, 2.



MSI - One Discrete Length

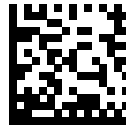

MSI - Two Discrete Lengths



\*MSI - Length Within Range (Default: 4 to 55)



MSI - Any Length

## MSI Check Digits

Parameter # 50 (SSI #32h)

This parameter checks the MSI check digit to verify that the data complies with the specified check digit algorithm.

With MSI symbols, one check digit is mandatory and always verified by the reader. The second check digit is optional. If the MSI codes include two check digits, select the Two MSI Check Digits option to enable verification of the second check digit.

- 0 - Does not check the MSI check digit; decodes MSI with no check digit.
- 1 - This is for MSI barcodes with one check digit. This is the default.
- 2 - This is for MSI barcodes with two check digits.

[MSI Check Digit Algorithm](#) to select second digit algorithms.



No MSI Check Digit (0)



\*One MSI Check Digits (1)



Two MSI Check Digit (2)

## Transmit MSI Check Digit(s)

### Parameter # 46 (SSI #2Eh)

This parameter transmits MSI data with or without the check digit.

- Enabled - transmits MSI data with check digit.
- \*Disabled - does not transmit MSI data check digit.



Transmit MSI Check Digit(s) (Enable) (1)



\*Do Not Transmit MSI Check Digit(s) (Disable) (0)

## MSI Check Digit Algorithm

### Parameter # 51 (SSI #33h)

This parameter selects the algorithm used to encode the check digit.

Two algorithms are available for verifying the second MSI check digit. Select one of the following options to select the algorithm used to encode the check digit.



MOD 11/MOD 10 (0)



\*MOD 10/MOD 10 (1)

## MSI Reduced Quiet Zone

### Parameter # 1392 (SSI #F8h 05h 70h)

This parameter enables or disables decoding MSI with reduced quiet zones (the margins on either side of the barcode).

If you select Enable, select a [1D Quiet Zone Level](#).

- \*Disabled - disables MSI with reduced Quiet Zones.
- Enabled - enables MSI with reduced Quiet Zones.



\*Disable MSI Reduced Quiet Zone (0)



Enable MSI Reduced Quiet Zone (1)

## Chinese 2 of 5

### Parameter # 408 (SSI #98h)

This parameter enables or disables Chinese 2 of 5.

- Enabled - enables Chinese 2 of 5.
- \*Disabled - disables Chinese 2 of 5.



Enable Chinese 2 of 5 (1)



\*Disable Chinese 2 of 5 (0)

## Korean 3 of 5

### Parameter # 581 (SSI #F1h 45h)

This parameter enables or disables Korean 3 of 5.

- Enabled - enables Korean 3 of 5.
- \*Disabled - disables Korean 3 of 5.



**NOTE:** The length for Korean 3 of 5 is fixed at 6.



Enable Korean 3 of 5 (1)



\*Disable Korean 3 of 5 (0)

## Inverse 1D

### Parameter # 586 (SSI #F1h 4Ah)

This parameter sets the 1D inverse decoder setting.

- Regular Only - The scanner decodes regular 1D barcodes only.
- Inverse Only - The scanner decodes inverse 1D barcodes only.
- Inverse Autodetect - The scanner decodes both regular and inverse 1D barcodes.



**NOTE:** This parameter does not apply to GS1 DataBarcode types.



**NOTE:** The Inverse 1D setting may impact Composite or Inverse Composite decoding.



\*Regular Only (0)

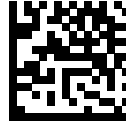

Inverse Only (1)



Inverse Autodetect (2)

## GS1 DataBar Omnidirectional (formerly GS1 DataBar-14)

The variants of GS1 DataBar are DataBar Omnidirectional, DataBar Limited, and DataBar Expanded. The limited and expanded versions have stacked variants. Scan the appropriate barcodes to enable or disable each variant of GS1 DataBar.

### Parameter # 338 (SSI #F0h 52h)

This parameter enables or disables the scanner to decode GS1 DataBar Omnidirectional barcodes.

- \*Enabled - enables GS1 DataBar Omnidirectional decoding.
- Disabled - disables GS1 DataBar Omnidirectional decoding.



\*Enable GS1 DataBar Omnidirectional (1)



Disable GS1 DataBar Omnidirectional (0)

## GS1 DataBar Limited

### Parameter # 339 (SSI #F0h 53h)

This parameter enables or disables the scanner to decode GS1 DataBar Limited barcodes.

- Enabled - enables GS1 DataBar Limited decoding.
- Disabled - disables GS1 DataBar Limited decoding.



Enable GS1 DataBar Limited (1)



Disable GS1 DataBar Limited (0)

## GS1 DataBar Expanded

### Parameter # 340 (SSI #F0h 54h)

This parameter enables or disables the scanner to decode GS1 DataBar Expanded barcodes.

- \*Enabled - enables GS1 DataBar Expanded decoding.
- Disabled - disables GS1 DataBar Expanded decoding.



\*Enable GS1 DataBar Expanded (1)

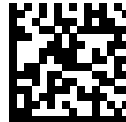

Disable GS1 DataBar Expanded (0)

## Convert GS1 DataBar to UPC/EAN/JAN

### Parameter # 397 (SSI #F0h, 8Dh)

This parameter enables or disables Convert GS1 DataBar to UPC/EAN/JAN.

- Enabled - enables Convert GS1 DataBar to UPC/EAN/JAN.
- \*Disabled - disables Convert GS1 DataBar to UPC/EAN/JAN.

This parameter only applies to GS1 DataBar Omnidirectional and GS1 DataBar Limited symbols not decoded as part of a Composite symbol. Enable Convert GS1 DataBar to UPC/EAN/JAN strips the leading '010' from DataBar Omnidirectional and DataBar Limited symbols encoding a single zero as the first digit, and then reports as EAN-13.

For barcodes beginning with between two and five zeros, this strips the leading '0100' and reports the barcode as UPC-A. The [UPC-A Preamble](#) option that transmits the system character and country code applies to converted barcodes. Note that neither the system character nor the check digit can be stripped.



Enable Convert GS1 DataBar to UPC/EAN/JAN (1)

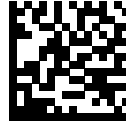

\*Disable Convert GS1 DataBar to UPC/EAN/JAN (0)

## GS1 DataBar Security Level

### Parameter # 1706 (SSI #F8h 06h AAh)

This parameter sets the security level for GS1 DataBar.

The scanner offers four levels of decode security for GS1 DataBar (GS1 DataBar Omnidirectional, GS1 DataBar Limited, GS1 DataBar Expanded) barcodes.

- Security Level 0 - The scanner operates in its most aggressive state, while providing sufficient security decoding most in-spec barcodes.
- \*Security Level 1 - This setting eliminates most misdecodes while maintaining reasonable aggressiveness.
- Security Level 2 - Select this option with greater barcode security requirements if Security Level 1 fails to eliminate misdecodes.
- Security Level 3 - If you selected Security Level 2 and misdecodes still occur, select this security level to apply the highest safety requirements.



GS1 DataBar Security Level 0 (0)



\*GS1 DataBar Security Level 1 (1)



GS1 DataBar Security Level 2 (2)



GS1 DataBar Security Level 3 (3)

## GS1 DataBar Limited Margin Check

### Parameter # 728 (SSI #F1h D8h)

This parameter sets the margin level for GS1 DataBar.

The scanner offers four levels of decode security for GS1 DataBar Limited barcodes. There is an inverse relationship between the level of margin check and scanner aggressiveness. Increasing the level of margin check can reduce scanning aggressiveness, so select only the level of margin check necessary.

- Margin Check Level 1 – No clear margin required. This complies with the original GS1 standard, yet can result in erroneous decoding of a DataBar Limited barcode when scanning some UPC symbols that start with digits 9 and 7.
- Margin Check Level 2 – Automatic risk detection. This level of margin check can result in erroneous decoding of DataBar Limited barcodes when scanning some UPC symbols. If a misdecode is detected, the scanner operates in Level 3 or Level 1.
- \*Margin Check Level 3 – Margin check level reflects the newly proposed GS1 standard that requires a five times trailing clear margin.
- Margin Check Level 4 – Margin check level extends beyond the standard required by GS1. This level of margin check requires a five times leading and trailing clear margin.



GS1 DataBar Limited Margin Check Level 1 (1)



GS1 DataBar Limited Margin Check Level 2 (2)



\*GS1 DataBar Limited Margin Check Level 3 (3)



GS1 DataBar Limited Margin Check Level 4 (4)

## GS1 Digital Link

### Parameter #2373 (SSI #F8h 09h 45h)

This parameter enables or disables GS1 Digital Link.



Enable (1)



\*Disable (0)

## GS1 Digital Link Mode

### Parameter #2374 (SSI #F8h 09h 46h )

This parameter selects the GS1 Digital Link Mode when the GS1 Digital Link is enabled.

- Mode 1 GTIN only: This mode sends either the 1D GTIN or 2D GTIN, whichever is decoded first.
- Mode 2 Prioritize 2D: This mode prioritizes the 2D GS1 Digital Link over 1D barcodes. If it sees the 2D within the GS1 Digital Link Prioritization Timeout, it reports the 2D barcode only. If it does not decode a 2D GS1 Digital Link barcode within the GS1 Digital Link Prioritization Timeout, it will report the 1D barcode, assuming the 1D was in the field of view and decoded.
- Mode 3 Corroborate 1D and 2D GTINs Match: The 1D barcode is reported if it is decoded before the 2D barcode. If a matching GTIN 2D barcode is seen within the GS1 Digital Link Prioritization Timeout, the 2D is also reported. The matching 1D and 2D barcodes have the same unique 8-digit prefix to indicate they have the same data. If the 2D is decoded first before the 1D, only the 2D is reported.



\*Mode 1: GTIN only (1)



Mode 2: Prioritize 2D (2)



Mode 3: Corroborate 1D and 2D GTINs Match (3)

## GS1 Digital Link Prioritization Timeout

### Parameter #2491 (SSI #F8h 09h BBh )

This parameter defines the maximum amount of time the scanner attempts to decode a 2D GS1 Digital Link barcode.

To set the GS1 Digital Link Prioritization Timeout, scan the barcode below. Then, scan four numeric barcodes from the [Numeric Barcodes](#) corresponding to the desired prioritization time. Enter leading zeroes for times of less than 4 values. For example, to enter 250 msec, scan **0 2 5 0**. To correct an error or change the selection, scan [Cancel](#).

- When the Digital Link Mode is set to Mode 2, this is the amount of time the scanner looks for the 2D GS1 Digital Link barcode. If the timer expires before finding the 2D GS1 barcode, the 1D barcode is sent.
- When the Digital Link Mode is set to Mode 3, if the 1D barcode is decoded first, this is the amount of time the scanner continues to look for the 2D barcode.



**NOTE:** This parameter is set in 1 msec increments.



Set Timeout

## Redundancy Level

### Parameter # 78 (SSI #4Eh)

This parameter selects the redundancy level appropriate for the barcode quality.

Select higher redundancy levels for decreasing levels of barcode quality. As redundancy levels increase, the scanner's aggressiveness decreases.

- \*Redundancy Level 1 - The scanner must read the following code types twice before decoding:
  - Codabar (8 characters or less)
  - MSI (4 characters or less)
  - D 2 of 5 (8 characters or less)
  - I 2 of 5 (8 characters or less)
- Redundancy Level 2 - The scanner must read all code types twice before decoding.
- Redundancy Level 3 - The scanner must read code types other than the following twice before decoding, but must read the following codes three times:
  - Codabar (8 characters or less)
  - MSI (4 characters or less)
  - D 2 of 5 (8 characters or less)
  - I 2 of 5 (8 characters or less)
- Redundancy Level 4 - The scanner must read all code types three times before decoding.



\*Redundancy Level 1 (1)

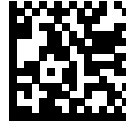

Redundancy Level 2 (2)



Redundancy Level 3 (3)



Redundancy Level 4 (4)

## Security Level

### Parameter # 77 (SSI #4Dh)

This parameter sets the security level.

The scanner offers four levels of decode security, which include the Code 128 family, UPC/EAN/JAN, and Code 93. Select increasing levels of security for decreasing levels of scanning quality. There is an inverse relationship between security and scanner aggressiveness, so choose only that level of security necessary for the application.

- Security Level 0 - The scanner operates in its most aggressive state, while providing sufficient security decoding most in-spec barcodes.
- Security Level 1 - This default setting eliminates most mis-decodes.
- Security Level 2 - Select this option if Security Level 1 fails to eliminate mis-decodes.
- Security Level 3 - If you selected Security Level 2 and mis-decodes still occur, select this security level.



**NOTE:** Selecting this option is an extreme measure against mis-decoding severely out-of-spec barcodes, and significantly impairs the decoding ability of the scanner. If this level of security is required, try to improve the quality of the barcodes.



Security Level 0 (0)



\*Security Level 1 (1)



Security Level 2 (2)



Security Level 3 (3)

## 1D Quiet Zone Level

### Parameter # 1288 (SSI #F8h 05h 08h)

This parameter sets the level of aggressiveness when setting a reduced quiet zone (the margin on either side of a barcode), and applies to symbologies enabled by a Reduced Quiet Zone parameter.

Because higher levels increase the decoding time and risk of mis-decodes, Zebra strongly recommends enabling only the symbologies which require higher quiet zone levels, and leaving Reduced Quiet Zone disabled for all other symbologies. Options are:

- 1D Quiet Zone Level 0 - The scanner performs normally in terms of quiet zone.
- \*1D Quiet Zone Level 1 - The scanner performs more aggressively in terms of quiet zone.
- 1D Quiet Zone Level 2 - The scanner only requires a quiet zone at the end of barcode for decoding.
- 1D Quiet Zone Level 3 - The scanner decodes anything in terms of quiet zone or end of barcode.



1D Quiet Zone Level 0 (0)



\*1D Quiet Zone Level 1 (1)

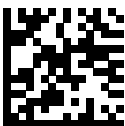

1D Quiet Zone Level 2 (2)



1D Quiet Zone Level 3 (3)

## Intercharacter Gap Size

### Parameter # 381 (SSI #F0h 7Dh)

This parameter enables a device to tolerate large intercharacter gap sizes.

The Code 39 and Codabar symbologies have an intercharacter gap that is typically quite small. Due to various barcode printing technologies, this gap can grow larger than the maximum size allowed, preventing the scanner from decoding the symbol. If this problem occurs, scan the Large Intercharacter Gaps parameter to tolerate these out-of-specification barcodes.



\*Normal Intercharacter Gaps (6)



Large Intercharacter Gaps (10)

## GS1-128 Emulation Mode for UCC/EAN Composite Codes

### Parameter # 427 (SSI #F0h ABh)

This parameter enables or disables GS1-128 Emulation Mode for UCC/EAN Composite Codes.

- Enabled - enables GS1-128 Emulation Mode for UCC/EAN Composite Codes.
- \*Disabled - disables GS1-128 Emulation Mode for UCC/EAN Composite Codes.



Enable GS1-128 Emulation Mode for UCC/EAN Composite Codes (1)



\*Disable GS1-128 Emulation Mode for UCC/EAN Composite Codes (0)

## PDF417

### Parameter # 15 (SSI 0Fh)

This parameter enables or disables the scanner to decode PDF417 barcodes.

- Enabled - enables PDF417 decoding.
- Disabled - disables PDF417 decoding.



Enable PDF417 (1)



Disable PDF417 (0)

## MicroPDF417

### Parameter # 227 (SSI #E3h)

This parameter enables or disables MicroPDF417.

- Enabled - enables MicroPDF417.
- \*Disabled - disables MicroPDF417.



Enable MicroPDF417 (1)



\*Disable MicroPDF417 (0)

## Code 128 Emulation

### Parameter # 123 (SSI #7Bh)

This parameter transmits data from certain MicroPDF417 symbols as Code 128.

You must enable [AIM Code Characters](#) for this parameter to work.

Enable Code 128 Emulation to transmit these MicroPDF417 symbols with one of the following prefixes:

```
]C1    if the first codeword is 903-905
```

]C2 if the first codeword is 908 or 909

]C0 if the first codeword is 910 or 911

Disable Code 128 Emulation to transmit these MicroPDF417 symbols with one of the following prefixes:

]L3 if the first codeword is 903-905

]L4 if the first codeword is 908 or 909

]L5 if the first codeword is 910 or 911



**NOTE:** Linked MicroPDF codewords 906, 907, 912, 914, and 915 are not supported. Use GS1 Composites instead.



Enable Code 128 Emulation (1)



\*Disable Code 128 Emulation (0)

## Data Matrix

### Parameter # 292 (SSI #F0h 24h)

This parameter enables or disables the scanner to decode Data Matrix barcodes.

- \*Enabled - enables Data Matrix decoding.
- Disabled - disables Data Matrix decoding.



\*Enable Data Matrix (1)

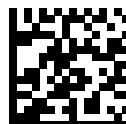

Disable Data Matrix (0)

## GS1 Data Matrix

### Parameter # 1336 (SSI #F8h 05h 38h)

This parameter enables or disables GS1 Data Matrix.

- Enabled - enables GS1 Data Matrix.
- \*Disabled - disables GS1 Data Matrix.



Enable GS1 Data Matrix (1)



\*Disable GS1 Data Matrix (0)

## Data Matrix Inverse

### Parameter # 588 (SSI #F1h 4Ch)

This parameter selects the Data Matrix inverse decoder setting.

- Regular Only - The scanner decodes regular Data Matrix barcodes only.
- Inverse Only - The scanner decodes inverse Data Matrix barcodes only.
- Inverse Autodetect - The scanner decodes both regular and inverse Data Matrix barcodes.



Regular Only (0)



Inverse Only (1)



Inverse Autodetect (2)

## Decode Data Matrix Mirror Images

### Parameter # 537 (SSI #F1h 19h)

This parameter selects an option for decoding Data Matrix mirror images.

- Never - Do not decode Data Matrix barcodes that are mirror images.
- Always - Decode only Data Matrix barcodes that are mirror images.
- \*Auto - Decode both mirrored and unmirrored Data Matrix barcodes.



Never (0)



Always (1)



\*Auto (2)

## QR Code

### Parameter # 293 (SSI #F0h 25h)

This parameter enables or disables the scanner to decode QR Code barcodes.

- \*Enabled - enables QR Code decoding.
- Disabled - disables QR Code decoding.



**NOTE:** Enabling this parameter also enables QR Mirrored and Linked QR.



\*Enable QR Code (1)



Disable QR Code (0)

## Weblink QR

### Parameter # 1947 (SSI #F8 07 9Bh)

This parameter enables or disables the scanner to decode Weblink QR barcodes.

- Disable Weblink QR Codes - prevents the scanner from decoding Weblink QR codes.
- Enable Weblink QR Codes - enables the scanner to decode Weblink QR codes.



\*Enable Weblink QR (1)



Disable Weblink QR (0)

## GS1 QR

### Parameter # 1343 (SSI #F8h 05h 3Fh)

This parameter enables or disables the scanner to decode GS1 QR barcodes.

- \*Enabled - enables GS1 QR decoding.
- Disabled - disables GS1 QR decoding.



\*Enable GS1 QR (1)



Disable GS1 QR (0)

## MicroQR

### Parameter # 573 (SSI #F1h 3Dh)

This parameter enables or disables the scanner to decode MicroQR barcodes.

- \*Enabled - enables MicroQR decoding.
- Disabled - disables MicroQR decoding.



\*Enable MicroQR (1)



Disable MicroQR (0)

## Linked QR Mode

### Parameter # 1847 (SSI #737h)

This parameter selects a linked QR mode.

- \*Linked QR Only - The scanner does not decode individual QR symbols from a set of linked QR codes.
- Individual QR With Headers - The scanner decodes individual QR symbols from a set of linked QR codes and retains the header information and data.
- Individual QR No Headers - The scanner decodes individual QR symbols from a set of linked QR codes and transmits the data without header information.



\*Linked QR Only (0)



Individual QR With Headers (1)



Individual QR No Headers (2)

## Aztec

### Parameter # 574 (SSI #F1h 3Eh)

This parameter enables or disables the scanner to decode Aztec barcodes.

- \*Enabled - enables Aztec decoding.
- Disabled - disables Aztec decoding.



**NOTE:** Enabling this parameter also enables Linked Aztec.



\*Enable Aztec (1)



Disable Aztec (0)

## Aztec Inverse

### Parameter # 589 (SSI #F1h 4Dh)

This parameter selects the Aztec inverse decoder setting.

- Regular Only - The scanner decodes regular Aztec barcodes only.
- Inverse Only - The scanner decodes inverse Aztec barcodes only.
- \*Inverse Autodetect - The scanner decodes both regular and inverse Aztec barcodes.



Regular Only (0)



Inverse Only (1)



\*Inverse Autodetect (2)

## Han Xin

### Parameter # 1167 (SSI #F8h 04h 8Fh)

This parameter enables or disables Han Xin.

- Enabled - enables Han Xin.
- \*Disabled - disables Han Xin.



Enable Han Xin (1)



\*Disable Han Xin (0)

## Han Xin Inverse

### Parameter # 1168 (SSI #F8h 04h 90h)

This parameter selects a Han Xin inverse decoder setting.

- \*Regular Only - The scanner decodes Han Xin barcodes with normal reflectance only.
- Inverse Only - The scanner decodes Han Xin barcodes with inverse reflectance only.
- Inverse Autodetect - The scanner decodes both regular and inverse Han Xin barcodes.



\*Regular Only (0)



Inverse Only (1)



Inverse Autodetect (2)

## Grid Matrix

### Parameter # 1718 (SSI #F8 06h B6h)

This parameter enables or disables Grid Matrix.

- Enabled - enables Grid Matrix.
- \*Disabled - disables Grid Matrix.

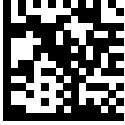

Enable Grid Matrix (1)

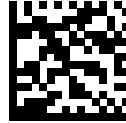

\*Disable Grid Matrix (0)

## Grid Matrix Inverse

### Parameter # 1719 (SSI #F8h 06h B7h)

This parameter selects a Grid Matrix inverse decoder setting.

- \*Regular Only - the imager decodes Grid Matrix barcodes with normal reflectance only.
- Inverse Only - the imager decodes Grid Matrix barcodes with inverse reflectance only.
- Inverse Autodetect - the imager decodes both regular and inverse Grid Matrix barcodes.



\*Regular (0)



Inverse Only (1)



Inverse Autodetect (2)

## Grid Matrix Mirrored

### Parameter # 1736 (SSI #F8h 06h C8h)

This parameter selects a mirror image Grid Matrix setting.

- \*Never Mirror - the imager decodes non-mirrored Grid Matrix barcodes only.
- Always Mirrored - the imager decodes mirrored Grid Matrix barcodes only.
- Autodetect - the imager decodes both mirrored and non-mirrored Grid Matrix barcodes.



\*Never Mirrored Only (0)



Always Mirrored Only (1)



Mirrored Autodetect (2)

## DotCode

### Parameter # 1906 (SSI #F8 07 72h)

You can enable or disable DotCode.

- Enabled - enables DotCode.
- \*Disabled - disables DotCode.



\*Disable DotCode (0)



Enable DotCode (1)

## DotCode Prioritize

### Parameter # 1937 (SSI #F8 07 91h)

This parameter enables or disables giving priority to DotCode decoding versus other symbologies.

- Disabled - disables DotCode as a priority.
- \*Enabled - enables DotCode as a priority.



\*Disable DotCode Prioritize (0)



\*Enable DotCode Prioritize (1)

## DotCode Inverse

### Parameter # 1907 (SSI #F8 07 73h)

This parameter selects the DotCode Inverse decoder setting.

- Regular Only - the device decodes DotCode Inverse codes with normal reflectance only.
- Inverse Only - the device decodes DotCode Inverse codes with inverse reflectance only.
- Inverse Autodetect - the device decodes DotCode Inverse codes with both normal and inverse reflectance.



Regular (0)



Inverse Only (1)



\*Inverse Autodetect (2)

## DotCode Mirrored

### Parameter # 1908 (SSI #F8 07 74h)

This parameter sets a DotCode Mirror decoder setting.

- Never - decodes non-mirrored DotCode codes only.
- Always - decodes mirrored DotCode codes only.
- \*Autodetect - decodes both mirrored and non-mirrored DotCode codes.



Never (0)



Always (1)



\*Autodetect (2)

## DotCode Erasure Limit

### Parameter # 2063 (SSI # F8 08 0F)

This parameter sets the maximum number of erasures in DotCode codewords before passing the codewords for error correction.

The value range is from 4 to 20. The default value is 10. A bigger value means that DotCode barcodes are easier to decode, but the chance of getting a decode error is higher.

To set a DotCode Erasure Limit value, scan the following barcode, and then scan two barcodes from [Numeric Barcodes](#) that correspond to the desired value. Enter a leading zero for single digit numbers. For example, to set an erasure value of 4, scan this barcode, and then scan the 0 and 4 barcodes. To correct an error or change the selection, scan Cancel.



DotCode Erasure Limit

# Numeric Barcodes

For parameters requiring specific numeric values, scan the appropriately numbered barcode(s).



0



1



2



3



4



5

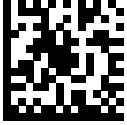

6



7



8



9

## Cancel

To correct an error or change a selection, scan the barcode below.



Cancel

# Alphanumeric Barcodes

For parameters requiring specific alphanumeric values, scan the appropriately numbered barcode(s).

## Cancel

To correct an error or change a selection, scan the barcode below.

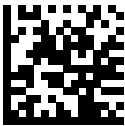

Cancel

## Alphanumeric Barcodes



Space



#



\$

# Alphanumeric Barcodes



\*



-



/



"



%



+



·

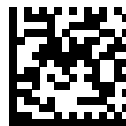

!



'



)



;



=



&



(

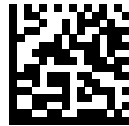

:



<

# Alphanumeric Barcodes



?



[



]



-



>

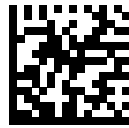

@



\



^



'



**NOTE:** Do not confuse the following barcodes with those on the numeric keypad.



0



1



2

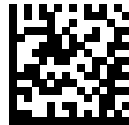

3



4

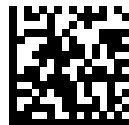

5

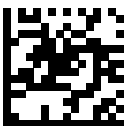

6



7



8



9



End of Message



Cancel

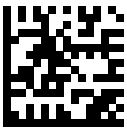

A



B

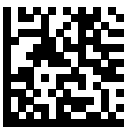

C



E



G



I



K



D



F



H



J

# Alphanumeric Barcodes



M



O



Q



S



L

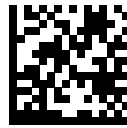

N



P

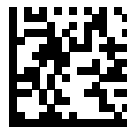

R

# Alphanumeric Barcodes



U



W

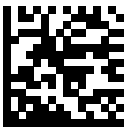

Y



a



T



V



X



Z



c



e



g



i



b



d



f



h



k



m



o



q



j



l

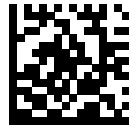

n



p

# Alphanumeric Barcodes



s



u



w



y



r



t



v

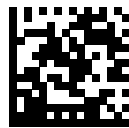

x



{



}



z



|

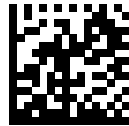

~

# ASCII Character Sets

Use this table to identify ASCII codes and their corresponding keyboard keystroke.



**NOTE:** For the Keyboard Wedge Interface, Code 39 Full ASCII interprets the barcode special character (\$ + % /) preceding a Code 39 character and assigns an ASCII character value to the pair. For example, if you enable Code 39 Full ASCII and scan +B, it transmits as b, %J as ?, and %V as @. Scanning ABC%l outputs the keystroke equivalent of ABC >.

**Table 17** ASCII Character Sets

ASCII Value (Prefix/ Suffix Value)	Full ASCII Code 39 Encode Char	Keystroke	ASCII Character (Applies to RS-232 Only)
1000	%U	CTRL 2	NUL
1001	\$A	CTRL A	SOH
1002	\$B	CTRL B	STX
1003	\$C	CTRL C	ETX
1004	\$D	CTRL D	EOT
1005	\$E	CTRL E	ENQ
1006	\$F	CTRL F	ACK
1007	\$G	CTRL G	BELL
1008	\$H	CTRL H/ <b>BACKSPACE</b> <sup>a</sup>	BCKSPC
1009	\$I	CTRL I/ <b>HORIZONTAL TAB</b> <sup>b</sup>	HORIZ TAB
1010	\$J	CTRL J	LF/NW LN
1011	\$K	CTRL K	VT
1012	\$L	CTRL L	FF
1013	\$M	CTRL M/ <b>ENTER</b> <sup>c</sup>	CR/ENTER
1014	\$N	CTRL N	SO
1015	\$O	CTRL O	SI
1016	\$P	CTRL P	DLE
1017	\$Q	CTRL Q	DC1/XON
1018	\$R	CTRL R	DC2

## ASCII Character Sets

**Table 17** ASCII Character Sets (Continued)

ASCII Value (Prefix/ Suffix Value)	Full ASCII Code 39 Encode Char	Keystroke	ASCII Character (Applies to RS-232 Only)
1019	\$S	CTRL S	DC3/XOFF
1020	\$T	CTRL T	DC4
1021	\$U	CTRL U	NAK
1022	\$V	CTRL V	SYN
1023	\$W	CTRL W	ETB
1024	\$X	CTRL X	CAN
1025	\$Y	CTRL Y	EM
1026	\$Z	CTRL Z	SUB
1027	%A	CTRL [	ESC
1028	%B	CTRL \	FS
1029	%C	CTRL ]	GS
1030	%D	CTRL 6	RS
1031	%E	CTRL -	US
1032	Space	Space	Space
1033	/A	!	!
1034	/B	"	"
1035	/C	#	#
1036	/D	\$	\$
1037	/E	%	%
1038	/F	&	&
1039	/G	'	'
1040	/H	(	(
1041	/I	)	)
1042	/J	*	*
1043	/K	+	+
1044	/L	,	,
1045	-	-	-
1046	.	.	.
1047	/o	/	/
1048	0	0	0
1049	1	1	1
1050	2	2	2
1051	3	3	3

**Table 17** ASCII Character Sets (Continued)

ASCII Value (Prefix/ Suffix Value)	Full ASCII Code 39 Encode Char	Keystroke	ASCII Character (Applies to RS-232 Only)
1052	4	4	4
1053	5	5	5
1054	6	6	6
1055	7	7	7
1056	8	8	8
1057	9	9	9
1058	/Z	:	:
1059	%F	;	;
1060	%G	<	<
1061	%H	=	=
1062	%I	>	>
1063	%J	?	?
1064	%V	@	@
1065	A	A	A
1066	B	B	B
1067	C	C	C
1068	D	D	D
1069	E	E	E
1070	F	F	F
1071	G	G	G
1072	H	H	H
1073	I	I	I
1074	J	J	J
1075	K	K	K
1076	L	L	L
1077	M	M	M
1078	N	N	N
1079	O	O	O
1080	P	P	P
1081	Q	Q	Q
1082	R	R	R
1083	S	S	S
1084	T	T	T

**Table 17** ASCII Character Sets (Continued)

ASCII Value (Prefix/ Suffix Value)	Full ASCII Code 39 Encode Char	Keystroke	ASCII Character (Applies to RS-232 Only)
1085	U	U	U
1086	V	V	V
1087	W	W	W
1088	X	X	X
1089	Y	Y	Y
1090	Z	Z	Z
1091	%K	[	[
1092	%L	\	\
1093	%M	]	]
1094	%N	^	^
1095	%O	_	_
1096	%W	`	`
1097	+A	a	a
1098	+B	b	b
1099	+C	c	c
1100	+D	d	d
1101	+E	e	e
1102	+F	f	f
1103	+G	g	g
1104	+H	h	h
1105	+I	i	i
1106	+J	j	j
1107	+K	k	k
1108	+L	l	l
1109	+M	m	m
1110	+N	n	n
1111	+O	o	o
1112	+P	p	p
1113	+Q	q	q
1114	+R	r	r
1115	+S	s	s
1116	+T	t	t
1117	+U	u	u

**Table 17** ASCII Character Sets (Continued)

ASCII Value (Prefix/ Suffix Value)	Full ASCII Code 39 Encode Char	Keystroke	ASCII Character (Applies to RS-232 Only)
1118	+V	v	v
1119	+W	w	w
1120	+X	x	x
1121	+Y	y	y
1122	+Z	z	z
1123	%P	{	{
1124	%Q		
1125	%R	}	}
1126	%S	~	~
1127			Undefined
7013			ENTER

- <sup>a</sup> The keystroke in bold transmits only if you enabled Function Key Mapping. Otherwise, the unbold keystroke transmits.
- <sup>b</sup> The keystroke in bold transmits only if you enabled Function Key Mapping. Otherwise, the unbold keystroke transmits.
- <sup>c</sup> The keystroke in bold transmits only if you enabled Function Key Mapping. Otherwise, the unbold keystroke transmits.

**Table 18** ALT Key Character Set

ALT Keys	Keystroke
2045	ALT -
2050	ALT 2
2054	ALT 6
2064	ALT @
2065	ALT A
2066	ALT B
2067	ALT C
2068	ALT D
2069	ALT E
2070	ALT F
2071	ALT G
2072	ALT H
2073	ALT I
2074	ALT J

**Table 18** ALT Key Character Set (Continued)

ALT Keys	Keystroke
2075	ALT K
2076	ALT L
2077	ALT M
2078	ALT N
2079	ALT O
2080	ALT P
2081	ALT Q
2082	ALT R
2083	ALT S
2084	ALT T
2085	ALT U
2086	ALT V
2087	ALT W
2088	ALT X
2089	ALT Y
2090	ALT Z
2091	ALT [
2092	ALT \
2093	ALT ]



**NOTE:** GUI Shift Keys - The Apple™ iMac keyboard has an apple key on either side of the space bar. Windows-based systems have a GUI key to the left of the left ALT key, and to the right of the right ALT key.

**Table 19** GUI Key Character Set

GUI Key	Keystroke
3000	Right Control Key
3048	GUI 0
3049	GUI 1
3050	GUI 2
3051	GUI 3
3052	GUI 4
3053	GUI 5
3054	GUI 6

**Table 19** GUI Key Character Set (Continued)

GUI Key	Keystroke
3055	GUI 7
3056	GUI 8
3057	GUI 9
3065	GUI A
3066	GUI B
3067	GUI C
3068	GUI D
3069	GUI E
3070	GUI F
3071	GUI G
3072	GUI H
3073	GUI I
3074	GUI J
3075	GUI K
3076	GUI L
3077	GUI M
3078	GUI N
3079	GUI O
3080	GUI P
3081	GUI Q
3082	GUI R
3083	GUI S
3084	GUI T
3085	GUI U
3086	GUI V
3087	GUI W
3088	GUI X
3089	GUI Y
3090	GUI Z

**Table 20** F Key Character Set

F Keys	Keystroke
5001	F 1

**Table 20** F Key Character Set (Continued)

F Keys	Keystroke
5002	F 2
5003	F 3
5004	F 4
5005	F 5
5006	F 6
5007	F 7
5008	F 8
5009	F 9
5010	F 10
5011	F 11
5012	F 12
5013	F 13
5014	F 14
5015	F 15
5016	F 16
5017	F 17
5018	F 18
5019	F 19
5020	F 20
5021	F 21
5022	F 22
5023	F 23
5024	F 24

# Programming Reference

This section provides symbol and AIM code identifiers.

## Symbol Code Identifiers

Symbol code identifiers identify the symbology type of decode data. The identifier may be appended to data transmitted to the host, or used in other ways to help identify decode data.

**Table 21** Symbol Code Characters

Code Character	Code Type
A	UPC-A, UPC-E, UPC-E1, EAN-8, EAN-13
B	Code 39, Code 32
C	Codabar
D	Code 128, ISBT 128, ISBT 128 Concatenated
E	Code 93
F	Interleaved 2 of 5
G	Discrete 2 of 5, or Discrete 2 of 5 IATA
H	Code 11
J	MSI
K	GS1-128
L	Bookland EAN
M	Trioptic Code 39
N	Coupon Code
R	GS1 DataBar Family
S	Matrix 2 of 5
T	UCC Composite, TLC 39
U	Chinese 2 of 5
V	Korean 3 of 5
X	ISSN EAN, PDF417, Macro PDF417, Micro PDF417

**Table 21** Symbol Code Characters (Continued)

Code Character	Code Type
z	Aztec, Aztec Rune
P00	Data Matrix
P01	QR Code, MicroQR
P02	Maxicode
P08	Netherlands KIX Code
P0A	USPS 4CB/One Code/Intelligent Mail
POC	Mailmark
POD	Grid Matrix
POG	GS1 Data Matrix
POH	Han Xin
POQ	GS1 QR
POX	Signature Capture

## AIM Code Identifiers

An AIM code identifier identifies the symbology type of decode data. The identifier may be appended to data transmitted to the host, or used in other ways to help identify decode data.

Each AIM Code Identifier contains the three-character string ]cm where:

] = Flag Character (ASCII 93)

c = Code Character (see table below)

m = Modifier Character (see table below)

**Table 22** AIM Code Characters

Code Character	Code Type
A	Code 39, Code 39 Full ASCII, Code 32
C	Code 128, ISBT 128, ISBT 128 Concatenated, GS1-128, Coupon (Code 128 portion)
d	Data Matrix, GS1 Data Matrix
E	UPC/EAN, Coupon (UPC portion)
e	GS1 DataBar Family
F	Codabar
G	Code 93

**Table 22** AIM Code Characters (Continued)

Code Character	Code Type
g	Grid Matrix
H	Code 11
h	Han Xin
I	Interleaved 2 of 5
L	PDF417, Macro PDF417, Micro PDF417
L2	TLC 39
M	MSI
Q	QR Code, MicroQR, GS1 QR
S	Discrete 2 of 5, IATA 2 of 5
U	Maxicode
z	Aztec, Aztec Rune
X	Bookland EAN, ISSN EAN, Trioptic Code 39, Chinese 2 of 5, Matrix 2 of 5, Korean 3 of 5, US Postnet, US Planet, UK Postal, Japan Postal, Australia Post, Netherlands KIX Code, USPS 4CB/One Code/ Intelligent Mail, UPU FICS Postal, Mailmark, Signature Capture

The modifier character is the sum of the applicable option values based on the following table.

**Table 23** Modifier Characters

Code Type	Option Value	Option
Code 39	0	No check character or Full ASCII processing.
	1	Reader has checked one check character.
	3	Reader has checked and stripped check character.
	4	Reader has performed Full ASCII character conversion.
	5	Reader has performed Full ASCII character conversion and checked one check character.
	7	Reader has performed Full ASCII character conversion and checked and stripped check character.
Example: A Full ASCII barcode with check character W, A+I+MI+DW, is transmitted as JA7AIMID where 7 = (3+4).		
Trioptic Code 39	0	No option specified at this time. Always transmit 0.
	Example: A Trioptic barcode 412356 is transmitted as JX0412356	
Code 128	0	Standard data packet, no Function code 1 in first symbol position.
	1	Function code 1 in first symbol character position.
	2	Function code 1 in second symbol character position.
	Example: A Code (EAN) 128 barcode with Function 1 character FNC1 in the first position, AIMID is transmitted as JC1AIMID	

**Table 23** Modifier Characters (Continued)

Code Type	Option Value	Option
I 2 of 5	0	No check digit processing.
	1	Reader has validated check digit.
	3	Reader has validated and stripped check digit.
	Example: An I 2 of 5 barcode without check digit, 4123, is transmitted as ]I04123	
Codabar	0	No check digit processing.
	1	Reader has checked check digit.
	3	Reader has stripped check digit before transmission.
	Example: A Codabar barcode without check digit, 4123, is transmitted as ]F04123	
Code 93	0	No options specified at this time. Always transmit 0.
	Example: A Code 93 barcode 012345678905 is transmitted as ]G0012345678905	
MSI	0	Check digits are sent.
	1	No check digit is sent.
	Example: An MSI barcode 4123, with a single check digit checked, is transmitted as ]M14123	
D 2 of 5	0	No options specified at this time. Always transmit 0.
	Example: A D 2 of 5 barcode 4123, is transmitted as ]S04123	
UPC/EAN	0	Standard data packet in full EAN format, i.e., 13 digits for UPC-A, UPC-E, and EAN-13 (not including supplemental data).
	1	Two digit supplemental data only.
	2	Five digit supplemental data only.
	3	Combined data packet comprising 13 digits from EAN-13, UPC-A or UPC-E symbol and 2 or 5 digits from supplemental symbol.
	4	EAN-8 data packet.
	Example: A UPC-A barcode 012345678905 is transmitted as ]E0012345678905	
Bookland EAN	0	No options specified at this time. Always transmit 0.
	Example: A Bookland EAN barcode 123456789X is transmitted as ]X0123456789X	
ISSN EAN	0	No options specified at this time. Always transmit 0.
	Example: An ISSN EAN barcode 123456789X is transmitted as ]X0123456789X	
Code 11	0	Single check digit
	1	Two check digits
	3	Check characters validated but not transmitted.
GS1 DataBar Family		No option specified at this time. Always transmit 0. GS1 DataBar Omnidirectional and GS1 DataBar Limited transmit with an Application Identifier "01". Note: In GS1-128 emulation mode, GS1 DataBar is transmitted using Code 128 rules (i.e., ]C1).

**Table 23** Modifier Characters (Continued)

Code Type	Option Value	Option
		Example: A GS1 DataBar Omnidirectional barcode 0110012345678902 is transmitted as Je00110012345678902.
EAN.UCC Composites (GS1 DataBar, GS1-128, 2D portion of UPC composite)		Native mode transmission.  <b>NOTE:</b> UPC portion of composite is transmitted using UPC rules.
	0	Standard data packet.
	1	Data packet containing the data following an encoded symbol separator character.
	2	Data packet containing the data following an escape mechanism character. The data packet does not support the ECI protocol.
	3	Data packet containing the data following an escape mechanism character. The data packet supports the ECI protocol.
		GS1-128 emulationNote: UPC portion of composite is transmitted using UPC rules.
	1	Data packet is a GS1-128 symbol (i.e., data is preceded with JJC1).
PDF417, Micro PDF417	0	Reader set to conform to protocol defined in 1994 PDF417 symbology specifications. Note: When this option is transmitted, the receiver cannot reliably determine whether ECIs have been invoked or whether data byte 92DEC has been doubled in transmission.
	1	Reader set to follow the ECI protocol (Extended Channel Interpretation). All data characters 92DEC are doubled.
	2	Reader set for Basic Channel operation (no escape character transmission protocol). Data characters 92DEC are not doubled. Note: When decoders are set to this mode, unbuffered Macro symbols and symbols requiring the decoder to convey ECI escape sequences cannot be transmitted.
	3	The barcode contains a GS1-128 symbol, and the first codeword is 903-907, 912, 914, 915.
	4	The barcode contains a GS1-128 symbol, and the first codeword is in the range 908-909.
	5	The barcode contains a GS1-128 symbol, and the first codeword is in the range 910-911.
		Example: A PDF417 barcode ABCD, with no transmission protocol enabled, is transmitted as JL2ABCD.
Data Matrix	0	ECC 000-140, not supported.
	1	ECC 200.
	2	ECC 200, FNC1 in first or fifth position.
	3	ECC 200, FNC1 in second or sixth position.
	4	ECC 200, ECI protocol implemented.
	5	ECC 200, FNC1 in first or fifth position, ECI protocol implemented.

**Table 23** Modifier Characters (Continued)

Code Type	Option Value	Option
	6	ECC 200, FNC1 in second or sixth position, ECI protocol implemented.
GS1 Data Matrix	2	ECC 200, FNC1 in first or fifth position.
MaxiCode	0	Symbol in Mode 4 or 5.
	1	Symbol in Mode 2 or 3.
	2	Symbol in Mode 4 or 5, ECI protocol implemented.
	3	Symbol in Mode 2 or 3, ECI protocol implemented in secondary message.
QR Code	0	Model 1 symbol.
	1	Model 2 / MicroQR symbol, ECI protocol not implemented.
	2	Model 2 symbol, ECI protocol implemented.
	3	Model 2 symbol, ECI protocol not implemented, FNC1 implied in first position.
	4	Model 2 symbol, ECI protocol implemented, FNC1 implied in first position.
	5	Model 2 symbol, ECI protocol not implemented, FNC1 implied in second position.
	6	Model 2 symbol, ECI protocol implemented, FNC1 implied in second position.
GS1 QR	3	Model 2 symbol, ECI protocol not implemented, FNC1 implied in first position.
Aztec	0	Aztec symbol.
	C	Aztec Rune symbol.
Han Xin	0	Generic data, no special features are set. The transmitted data does not follow the AIM ECI protocol.
	1	ECI protocol enabled. There is at least one ECI mode encoded. Transmitted data must follow the AIM ECI protocol.
Mailmark	0	No option specified at this time. Always transmit 0.

# Communication Protocol Functionality

This section provides information about functionality supported via communication (cable) interface. The following table lists supported scanner functionality by communication protocol.

**Table 24** Communication Interface Functionality

Communication Interfaces	Functionality		
	Data Transmission	Remote Management	Image and Video Transmission
<b>USB</b>			
HID Keyboard Emulation	Supported	Not Available	Not Available
CDC COM Port Emulation	Supported	Not Available	Not Available
SSI over CDC COM Port Emulation	Supported	Supported	Supported
IBM Table-top USB	Supported	Supported	Not Available
IBM Hand-held USB	Supported	Supported	Not Available
USB OPOS Hand-held	Supported	Supported	Not Available
Symbol Native API (SNAPI) without Imaging Interface	Supported	Supported	Not Available
Symbol Native API (SNAPI) with Imaging Interface	Supported	Supported	Supported
<b>RS-232</b>			
Standard RS-232	Supported	Not Available	Not Available
ICL RS-232	Supported	Not Available	Not Available
Fujitsu RS-232	Supported	Not Available	Not Available
Wincor-Nixdorf RS-232 Mode A	Supported	Not Available	Not Available
Wincor-Nixdorf RS-232 Mode B	Supported	Not Available	Not Available
Olivetti ORS4500	Supported	Not Available	Not Available
Omron	Supported	Not Available	Not Available
CUTE	Supported	Not Available	Not Available
OPOS/JPOS	Supported	Not Available	Not Available
SSI	Supported	Supported	Supported

# Country Codes

This section provides instructions for programming the keyboard to interface with a USB or keyboard wedge host.

The host powers the scanner. For host setup information, see [USB Interface and Keyboard Wedge Interface](#).

To select a code page for the country keyboard type, see [Country Code Barcodes](#).

Throughout the programming barcode menus, default values are indicated with asterisks (\*).

## USB and Keyboard Wedge Country Keyboard Types (Country Codes)

Scan the barcode corresponding to the keyboard type. For a USB host, this setting applies only to the USB Keyboard (HID) device. If the keyboard type is not listed, see [Keypad Emulation](#) for the USB HID host. For a keyboard wedge host, see [Alternate Numeric Keypad Emulation](#).



**NOTE:** When changing USB country keyboard types, the scanner automatically resets and issues the standard startup beep sequences.

For best results when using international keyboards, enable [USB Keyboard Emulation](#).



**IMPORTANT:** Some country keyboard barcode types are specific to certain Windows operating systems (i.e., XP and Windows 7 and above). Barcodes requiring a specific Windows OS are noted in the barcode captions.

Use the French International barcode for Belgian French keyboards.

## Country Code Barcodes

### Parameter # 960

This chapter provides instructions for programming the keyboard to interface with a USB, BT HID, or keyboard wedge host. The host powers the scanner.



\*US English (North American)

## Country Codes



Albanian



Arabic (102)



Azeri (Latin)

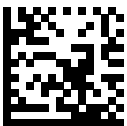

Belarusian

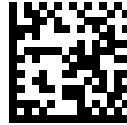

US English (Mac)



Arabic (101)



Arabic (102) AZERTY

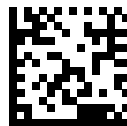

Azeri (Cyrillic)



Bosnian (Latin)



Bosnian (Cyrillic)



Bulgarian (Latin)



Bulgarian Cyrillic (Typewriter) (Bulgarian -Windows XP Typewriter - Windows 7 or higher)

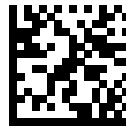

Canadian French Win7



Canadian French (Legacy)



Canadian Multilingual Standard

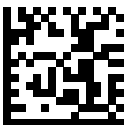

Chinese (ASCII)

## Country Codes



Chinese (Simplified)\*



Chinese (Traditional)\*

\*For CJK keyboard types, see [CJK Decode Control](#).



Croatian



Czech

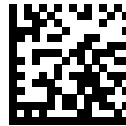

Czech (Programmer)

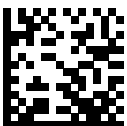

Czech (QWERTY)

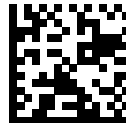

Danish



Dutch (Netherlands)

## Country Codes



Faeroese

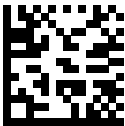

French (France)



Greek Latin

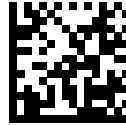

Estonian

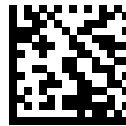

Finnish

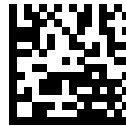

French International (Belgian French)



Galician



German

## Country Codes



Greek (220) Latin



Greek (319) Latin

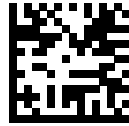

Greek



Greek (220)



Greek (319)



Greek Polytonic



Hebrew Israel

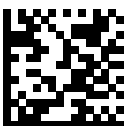

Hungarian

## Country Codes



Hungarian\_101KEY



Icelandic

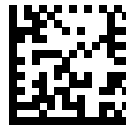

Irish

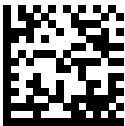

Italian



Italian (142)



Japanese (ASCII)



Japanese (SHIFT-JIS)\*

\*For CJK keyboard types, see [CJK Decode Control](#).



Kazakh

## Country Codes



Korean (ASCII)

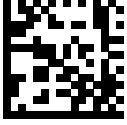

Korean (Hangul)\*

\*For CJK keyboard types, see [CJK Decode Control](#).

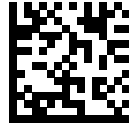

Kyrgyz



Latin American



Latvian



Latvian (QWERTY)



Lithuanian

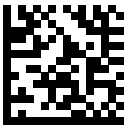

Lithuanian (IBM)

## Country Codes



Macedonian (FYROM)



Maltese\_47KEY



Mongolian



Norwegian

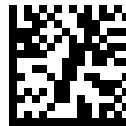

Polish (214)

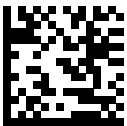

Polish (Programmer)



Portuguese (Portugal)

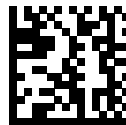

Russian

## Country Codes

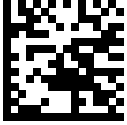

Russian (Typewriter)

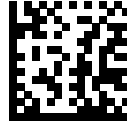

Serbian (Latin)



Serbian (Cyrillic)

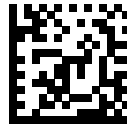

Slovak



Slovak (QWERTY)



Slovenian

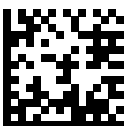

Spanish



Spanish (Variation)

## Country Codes



Swedish



Swiss French



Swiss German



Tatar



Thai (Kedmanee)

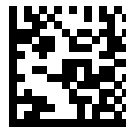

Turkish F



Turkish Q

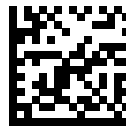

UK English

## Country Codes



Ukrainian



US Dvorak



US Dvorak Left



US Dvorak Right

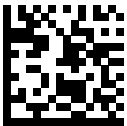

US International



Uzbek

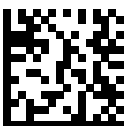

Vietnamese

# Country Code Pages

This section provides barcodes for selecting code pages for the country keyboard type selected in Country Codes.

If the default code page in [Country Code Pages](#) is appropriate for your selected country keyboard type, you do not need to scan a country code page barcode.



**NOTE:** ADF rules can also specify a code page based on the symbology and other ADF criteria. Refer to the Advanced Data Formatting Programmer Guide.

## Country Code Page Defaults

The table in this section lists the code page default for each country keyboard.

**Table 25** Country Code Page Defaults

Country Keyboard	Code Page Default
US English (North American)	Windows 1252
US English (Mac)	Mac CP10000
Albanian	Windows 1250
Arabic 101	Windows 1256
Arabic 102	Windows 1256
Arabic 102 AZERTY	Windows 1256
Azeri Latin	Windows 1254
Azeri Cyrillic	Windows 1251
Belarusian	Windows 1251
Bosnian Latin	Windows 1250
Bosnian Cyrillic	Windows 1251
Bulgarian Latin	Windows 1250
Bulgarian Cyrillic	Windows 1251
Canadian French Win7	Windows 1252
Canadian French (Legacy)	Windows 1252
Canadian Multilingual	Windows 1252

**Table 25** Country Code Page Defaults (Continued)

Country Keyboard	Code Page Default
Croatian	Windows 1250
Chinese ASCII	Windows 1252
Chinese (Simplified)	Windows 936, GBK
Chinese (Traditional)	Windows 950, Big5
Czech	Windows 1250
Czech Programmers	Windows 1250
Czech QWERTY	Windows 1250
Danish	Windows 1252
Dutch Netherland	Windows 1252
Estonian	Windows 1257
Faeroese	Windows 1252
Finnish	Windows 1252
French (France)	Windows 1252
French International (Belgian French)	Windows 1252
Galician	Windows 1252
German	Windows 1252
Greek Latin	Windows 1252
Greek220 Latin	Windows 1253
Greek319 Latin	Windows 1252
Greek	Windows 1253
Greek220	Windows 1253
Greek319	Windows 1253
Greek Polytonic	Windows 1253
Hebrew Israel	Windows 1255
Hungarian	Windows 1250
Hungarian_101KEY	Windows 1250
Icelandic	Windows 1252
Irish	Windows 1252
Italian	Windows 1252
Italian_142	Windows 1252
Japanese ASCII	Windows 1252
Japanese (Shift-JIS)	Windows 932, Shift-JIS
Kazakh	Windows 1251

**Table 25** Country Code Page Defaults (Continued)

Country Keyboard	Code Page Default
Korean ASCII	Windows 1252
Korean (Hangul)	Windows 949, Hangul
Kyrgyz Cyrillic	Windows 1251
Latin America	Windows 1252
Latvian	Windows 1257
Latvian QWERTY	Windows 1257
Lithuanian	Windows 1257
Lithuanian_IBM	Windows 1257
Macedonian -FYROM	Windows 1251
Maltese_47KEY	Windows 1252
Mongolian-Cyrillic	Windows 1251
Norwegian	Windows 1252
Polish_214	Windows 1250
Polish Programmer	Windows 1250
Portuguese Portugal	Windows 1252
Russian	Windows 1251
Russian Typewriter	Windows 1251
Serbian Latin	Windows 1250
Serbian Cyrillic	Windows 1251
Slovak	Windows 1250
Slovak QWERTY	Windows 1250
Slovenian	Windows 1250
Spanish	Windows 1252
Spanish Variation	Windows 1252
Swedish	Windows 1252
Swiss French	Windows 1252
Swiss German	Windows 1252
Tatar	Windows 1251
Thai-Kedmanee	Windows 874
Turkish F	Windows 1254
Turkish Q	Windows 1254
Ukrainian	Windows 1251
United Kingdom	Windows 1252

**Table 25** Country Code Page Defaults (Continued)

Country Keyboard	Code Page Default
United States	Windows 1252
US Dvorak	Windows 1252
US Dvorak Left Hand	Windows 1252
US Dvorak Right Hand	Windows 1252
US International	Windows 1252
Uzbek Cyrillic	Windows 1251
Vietnamese	Windows 1258

## Country Code Page Barcodes

### Parameter # 961

Scan the barcode corresponding to the country keyboard code page.

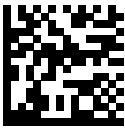

Windows 1250 Latin 2, Central European



Windows 1251 Cyrillic, Slavic



Windows 1252 Latin 1, Western European



Windows 1253 Greek



Windows 1254 Latin 5, Turkish



Windows 1255 Hebrew



Windows 1256 Arabic



Windows 1257 Baltic



Windows 1258 Vietnamese



Windows 874 Thai



Windows 20866 Cyrillic KOI8-R

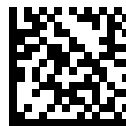

Windows 932 Japanese Shift-JIS

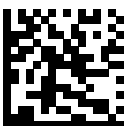

Windows 936 Simplified Chinese GBK



Windows 54936 Simplified Chinese GB18030



Windows 949 Korean Hangul

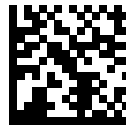

Windows 950 Traditional Chinese Big5



MS-DOS 437 Latin US

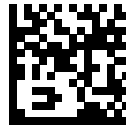

MS-DOS 737 Greek



MS-DOS 775 Baltic



MS-DOS 850 Latin 1



MS-DOS 852 Latin 2

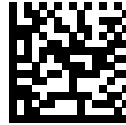

MS-DOS 855 Cyrillic



MS-DOS 857 Turkish



MS-DOS 860 Portuguese



MS-DOS 861 Icelandic

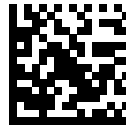

MS-DOS 862 Hebrew



MS-DOS 863 French Canada



MS-DOS 865 Nordic

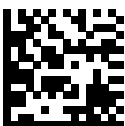

MS-DOS 866 Cyrillic



MS-DOS 869 Greek 2



ISO 8859-1 Latin 1, Western European



ISO 8859-2 Latin 2, Central European



ISO 8859-3 Latin 3, South European



ISO 8859-4 Latin 4, North European



ISO 8859-5 Cyrillic

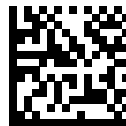

ISO 8859-6 Arabic



ISO 8859-7 Greek



ISO 8859-8 Hebrew



ISO 8859-9 Latin 5, Turkish

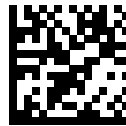

ISO 8859-10 Latin 6, Nordic



ISO 8859-11 Thai

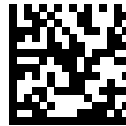

ISO 8859-13 Latin 7, Baltic



ISO 8859-14 Latin 8, Celtic



ISO 8859-15 Latin 9

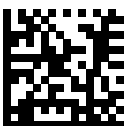

ISO 8859-16 Latin 10, South-Eastern European



UTF-8



UTF-16LE UTF-16 Little Endian



UTF-16BE UTF-16 Big Endian



Mac CP10000 Roman

# CJK Decode Control

This section describes control parameters for CJK (Chinese, Japanese, Korean) barcode decode through USB HID Keyboard Emulation mode.



**NOTE:** Because ADF does not support CJK character processing, there is no format manipulation for CJK output.

## CJK Control Parameters

### Unicode Output Control

#### Parameter # 973 (SSI # F2h CDh)

For a Unicode encoded CJK barcode, select one of the following options for Unicode output. Universal Output applies to Unicode and MBCS-expected applications, while Unicode Application Only is limited to Unicode-expected applications.

- **Universal Output to Unicode and MBCS Application:** This default method applies to Unicode and MBCS expected applications, such as MS Word and Notepad on a Windows host.



**NOTE:** To support Unicode universal output, set up the registry table for the Windows host. See [Unicode/CJD Decode Setup with Windows Host](#).

- **Output to Unicode Application Only** - This method applies only to Unicode expected applications, such as MS Word and WordPad, but not Notepad.



\*Universal Output (0)



Unicode Application Only (1)

## CJK Output Method to Windows Host

#### Parameter # 972

For a national standard encoded CJK barcode, select one of the following options for CJK output to a Windows host:

- **Universal CJK Output:** This is the default universal CJK output method for US English IME or Chinese/Japanese/Korean ASCII IME on a Windows host. This method converts CJK characters to Unicode and emulates the characters when transmitting to the host. Use the [Unicode Output Control](#) parameter to control Unicode output.



**NOTE:** To support universal CJK output, set up the registry table for the Windows host. See [Unicode/CJK Decode Setup Windows Host](#).

- **Other options for CJK output** - With the following methods, the scanner sends the CJK character hexadecimal internal code (Nei Ma) value to the host, or converts the CJK character to Unicode and sends the hexadecimal Unicode value to the host. When using these methods, the Windows host must select the corresponding IME to accept the CJK character. See [Unicode/CJK Decode Setup Windows Host](#).
- **Japanese Unicode Output**
- **Simplified Chinese GBK Code Output**
- **Simplified Chinese Unicode Output**
- **Korean Unicode Code Output**
- **Traditional Chinese Big5 Code Output** (Windows XP)
- **Traditional Chinese Big5 Code Output** (Windows 7)
- **Traditional Chinese Unicode Code Output** (Windows XP)
- **Traditional Chinese Unicode Code Output** (Windows 7)



**NOTE:** The Unicode emulate output method depends on the host system (Windows XP or Windows 7).



\*Universal CJK Output (0)



Japanese Unicode Output (34)



Chinese (Simplified) GBK Output (1)

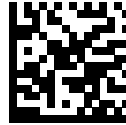

Chinese (Simplified) Unicode Output (2)



Korean Unicode Output (50)

(for Korean Unicode Output, select Simplified Chinese Unicode IME on the Windows host)



Chinese (Traditional) Big5 Output (Windows XP) (17)



Chinese (Traditional) Big5 Output (Windows 7) (19)



Chinese (Traditional) Unicode Output (Windows XP) (18)



Chinese (Traditional) Unicode Output (Windows 7) (20)

## Non-CJK UTF Barcode Output

### Parameter # 960

Some country keyboard type layouts contain characters that do not exist in the default code page (see below). Although the default code page can not encode these characters in a barcode, they can be encoded in the UTF-8 barcode.

Scan the following barcode to output the Unicode values by emulation mode.



**NOTE:** Use this special country keyboard type to decode the non-CJK UTF-8 barcode. After decoding, re-configure the scanner to use the original country keyboard type.

Use US English IME on Windows. See [Unicode Output Control](#).



Non-CJK UTF-8 Emulation Output

**Missing Characters for Country Keyboard Type: Tatar, Uzbek, Mongolian, Kyrgyz, Kazakh and Azeri**

Default code page: CP1251

Missing characters:

ƒ	ƒ
χ	χ
κ	κ
h	h
ə	ə
ә	ә
γ	γ
Ғ	Ғ
Ж	Ж
Ғ	
Ғ	Ғ
Ү	Ү
Қ	Қ
Ч	Ч
К	К

**Missing Characters for Country Keyboard Type: Romanian (Standard)**

Default code page: CP1250

Missing characters:

Ș	Ș
ț	Ț

**Missing Characters for Country Keyboard Type: Portuguese-Brazilian (ABNT), Portuguese-Brazilian (ABNT2)**

Default code page: CP1252

Missing character: Ğ

### Missing Characters for Country Keyboard Type: Azeri-Latin

Default code page: CP1254

Missing characters: ə, Ә

## Unicode/CJK Decode Setup with Windows Host

This section describes how to set up CJK decode with a Windows host.

### Setting Up the Windows Registry Table for Unicode Universal Output

Set up a Windows host registry table in order to support a universal output method for your data.

1. Select **Start > Run > regedt32** to start the registry editor.
2. Under **HKEY\_Current\_User\Control Panel\Input Method**, set **EnableHexNumpad** to **1** as follows:

```
[HKEY_CURRENT_USER\Control Panel\Input Method]
```

```
"EnableHexNumpad" = "1"
```

If this key does not exist, add it as type **REG\_SZ** (string value).

3. Reboot the computer to implement the registry change.

### Adding CJK IME on Windows

Modify your host device to display a Chinese, Japanese, or Korean keyboard.

1. Click **Start > Control Panel**.
2. If the Control Panel opens in category view, select **Switch to Classic View** in the top left corner.
3. Select **Regional and Language Options**.
4. Click the **Language** tab.
5. Under **Supplemental Language Support**, select the **Install Files for East Asian Languages** check box if not already selected, and click **Apply**. This may require a Windows installation CD to install the required files. This step ensures that the East Asian Languages (CJK) are available.
6. Under **Text Services and Input Language**, click **Details**.
7. Under **Installed Services**, click **Add**.
8. In the **Add Input Language** dialog box, choose the CJK input language and keyboard layout or Input Method Editor (IME) to add.
9. Click **OK** twice. The language indicator appears in the system tray (at bottom right corner of the desktop by default). To switch between input languages (keyboard languages) select the language indicator in the system tray.
10. Select the language indicator in the system tray to select the desired country keyboard type.

- 11. Verify that the characters displayed on each country's keyboard appear.

## Selecting the Simplified Chinese Input Method on the Host

You can display a Simplified Chinese keyboard as the input method from the SP20 to display on your Windows 7 / Windows XP host device.

- Select Unicode/GBK input on Windows XP: **Chinese (Simplified) - NeiMa**, then click the input bar to select **Unicode** or **GBK NeiMa** input.

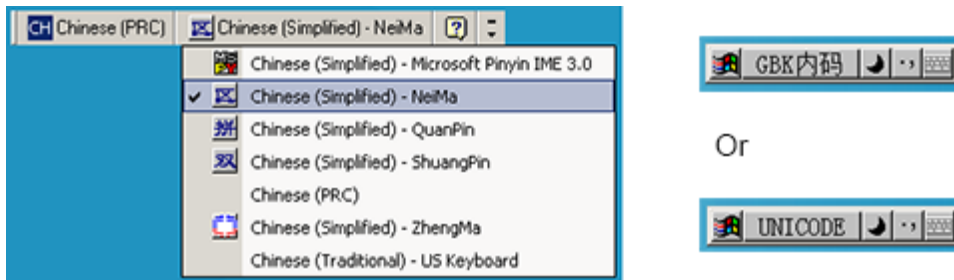

- Select Unicode/GBK input on Windows 7: **Chinese (Simplified) - Microsoft Pinyin New Experience Input Style**, then select **Tool Menu > Secondary Inputs > Unicode Input** or **GB Code Input**.

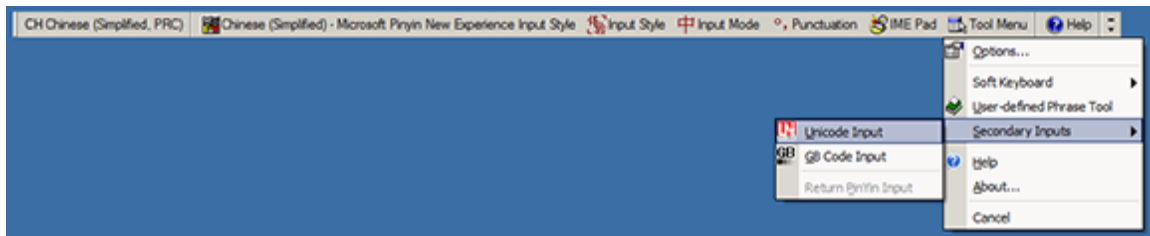

## Selecting the Traditional Chinese Input Method on the Host

To select the Traditional Chinese input method:

- Select Unicode input on Windows XP: **Chinese (Traditional) - Unicode**

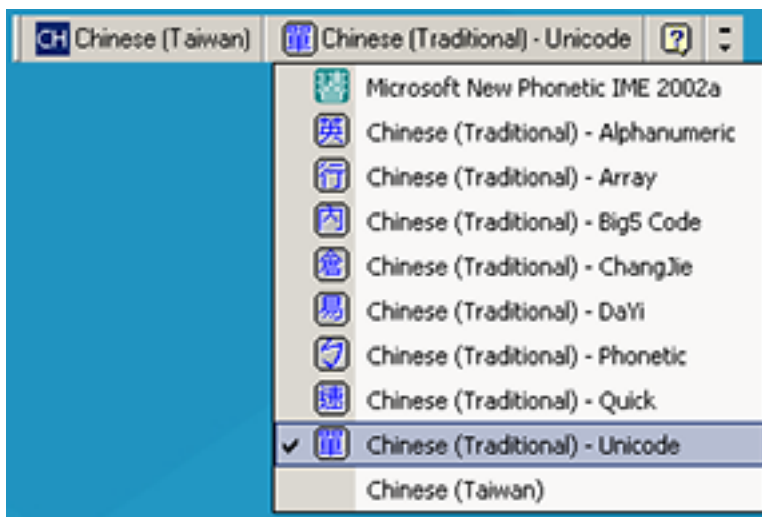

- Select Big5 input on Windows XP: **Chinese (Traditional) - Big5 Code**

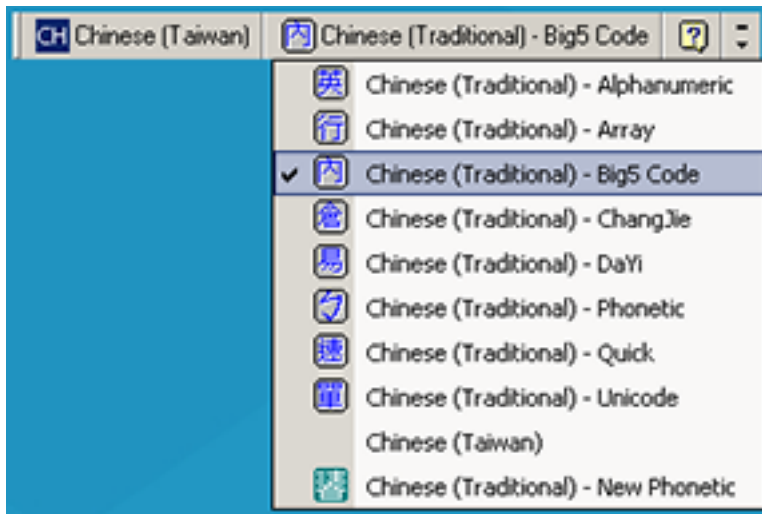

- Select Unicode/Big5 input on Windows 7: **Chinese (Traditional) - New Quick**. This option support both Unicode and Big5 input.

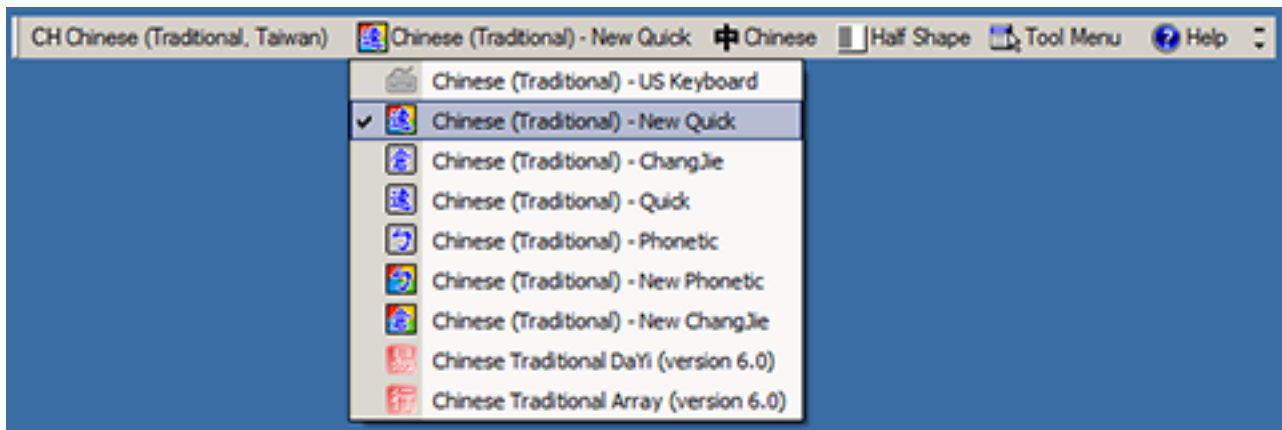

# Non-Parameter Attributes

This section defines the scanner's non-parameter attributes.

## Model Number

Attribute #533

The model number of the scanner. This electronic output matches the printout on the physical device label.

Type	S
Size (Bytes)	18
User Mode Access	R
Values	Variable

## Serial Number

Attribute #534

The unique serial number assigned in the manufacturing facility. This electronic output matches the printout on the physical device label, for example M1J26F45V.

Type	S
Size (Bytes)	16
User Mode Access	R
Values	Variable

## Date of Manufacture

Attribute #535 Date of device manufacture assigned in the manufacturing facility. This electronic output matches the printout on the physical device label, for example, 30APR14 (which reads the 30th of April 2014).

Attribute Property	Property Value
Type	S
Size (Bytes)	7
User Mode Access	R

Attribute Property	Property Value
Values	Variable

### Date of First Programming

Attribute #614

This attribute contains the date of first electronic programming represents the first time settings were electronically loaded to the scanner either by 123Scan or via SMS, for example 18MAY14 (which reads the 18th of May 2014).

Attribute Property	Property Value
Type	S
Size (Bytes)	7
User Mode Access	R
Values	Variable

### Configuration Filename

**Parameter # 616**

Scanning the Set Defaults barcode automatically changes the configuration filename to factory defaults. To indicate the configuration settings loaded to the device were changed, the configuration filename changes to Modified upon scanning any parameter barcode.

Attribute Property	Property Value
Type	S
Size (Bytes)	17
User Mode Access	RW
Values	Variable

## Beeper/LED

Attribute #6000

Activates the beeper and/or LED.

Attribute Property	Property Value
Type	X
Size (Bytes)	N/A
User Mode Access	W
Values	See <a href="#">Beeper/LED Values</a>

**Table 26** Beeper/LED Values

Beep / LED Action	Value	Beep / LED Action	Value
1 high short beep	0	1 low long beep	15
2 high short beeps	1	2 low long beeps	16
3 high short beeps	2	3 low long beeps	17
4 high short beeps	3	4 low long beeps	18
5 high short beeps	4	5 low long beeps	19
1 low short beep	5	Fast warble beep	20
2 low short beeps	6	Slow warble beep	21
3 low short beeps	7	High-low beep	22
4 low short beeps	8	Low-high beep	23
5 low short beeps	9	High-low-high beep	24
1 high long beep	10	Low-high-low beep	25
2 high long beeps	11	High-high-low-low beep	26
3 high long beeps	12	Green LED off	42
4 high long beeps	13	Green LED on	43
5 high long beeps	14	Red LED on	47
		Red LED off	48

## Parameter Defaults

Attribute #6001

This attribute restores all parameters to their factory defaults.

Attribute Property	Property Value
Type	X
Size (Bytes)	N/A
User Mode Access	W

Attribute Property	Property Value
Values	0 = Restore Defaults 1 = Restore Factory Defaults 2 = Write Custom Defaults

### Beep on Next Bootup

Attribute #6003

This attribute configures (enables or disables) beep on next boot up of scanner.

Attribute Property	Property Value
Type	X
Size (Bytes)	N/A
User Mode Access	W
Values	0 = Disable beep on next bootup 1 = Enable beep on next bootup

### Reboot

Attribute #6004

This attribute initiates a device reboot.

Attribute Property	Property Value
Type	X
Size (Bytes)	N/A
User Mode Access	W
Values	N/A

### Host Trigger Session

Attribute #6005

This attribute triggers a decode session.

Attribute Property	Property Value
Type	X
Size (Bytes)	N/A
User Mode Access	W
Values	1 = Start Host Trigger Session 0 = Stop Host Trigger Session

### Firmware Version

Parameter # 20004

## Non-Parameter Attributes

This parameter returns the scanner's operating system version. For example, NBRFMAAC or PAAAABS00-007-R03D0.

Attribute Property	Property Value
Type	S
Size (Bytes)	Variable
User Mode Access	R
Values	Variable

## Scankit Version

Attribute #20008

Identifies the 1D decode algorithms resident on the device, for example SKIT4.33T02.

Attribute Property	Property Value
Type	S
Size (Bytes)	Variable
User Mode Access	R
Values	Variable

# Sample Barcodes

This section provides sample barcodes.

## Sample Code 39



## Sample Code 93

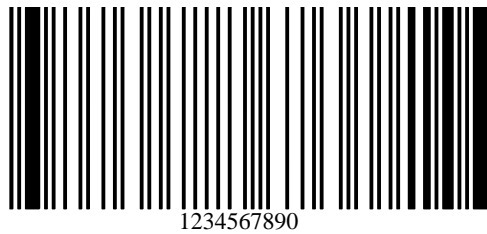

## Sample UPC/EAN

UPC-A, 100%



UPC-A Plus 2



# Sample Barcodes

**UPC-A Plus 5**



**UPC-E**

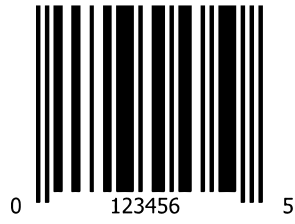

**UPC-E Plus 2**

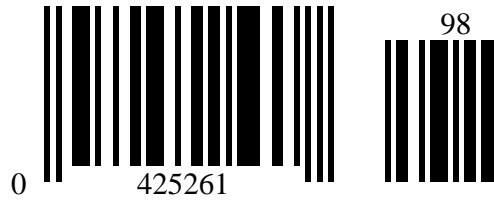

**UPC-E Plus 5**



**EAN-8**



**EAN-13, 100%**

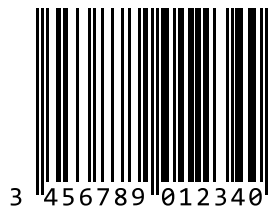

**EAN-13 Plus 2**



**EAN-13 Plus 5**



**Sample Code 128**



**Sample Interleaved 2 of 5**



**Sample Chinese 2 of 5**



## Sample Matrix 2 of 5



## Sample Korean 3 of 5



## Sample GS1 DataBar

### GS1 DataBar Omnidirectional



**NOTE:** GS1 DataBar Omnidirectional must be enabled to read the following barcode (see [GS1 DataBar Omnidirectional \(formerly GS1 DataBar-14\)](#)).

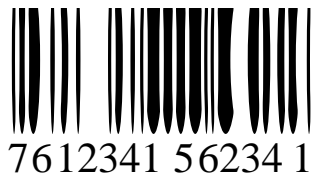

### GS1 DataBar Limited



**NOTE:** DataDataBar Limited must be enabled to read the following barcode (see [GS1 DataBar Limited](#)).



**GS1 DataBar Expanded**



**NOTE:** DataBar Expanded must be enabled to read the following barcode (see [GS1 DataBar Expanded](#)).

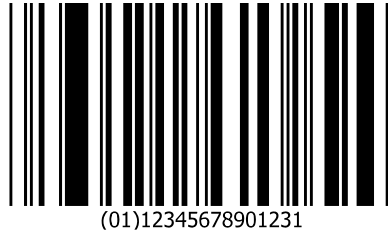

**Sample PDF417**

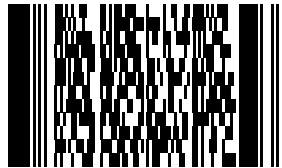

**Sample Data Matrix**



123456789abcdefghijklmnopqrstuvwxyz

**Sample Aztec**



0123456789ABCDEFGHIJKLMNOPQRSTUVWXYZ0123456789ABCDEFGHIJKLMNOPQRSTUVWXYZ  
WXYZ01234567890123456789ABCDEFGHIJKLMNOPQRSTUVWXYZ0123456789ABCDEFGHI  
JKLMNOPQRSTUVWXYZ0123456789

**Sample Grid Matrix**



**NOTE:** Grid Matrix must be enabled to read the following bar code (see [Grid Matrix](#)).

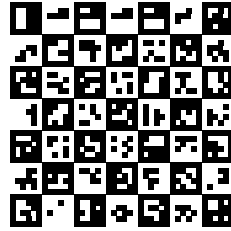

**Sample GS1 DataBar Truncated**

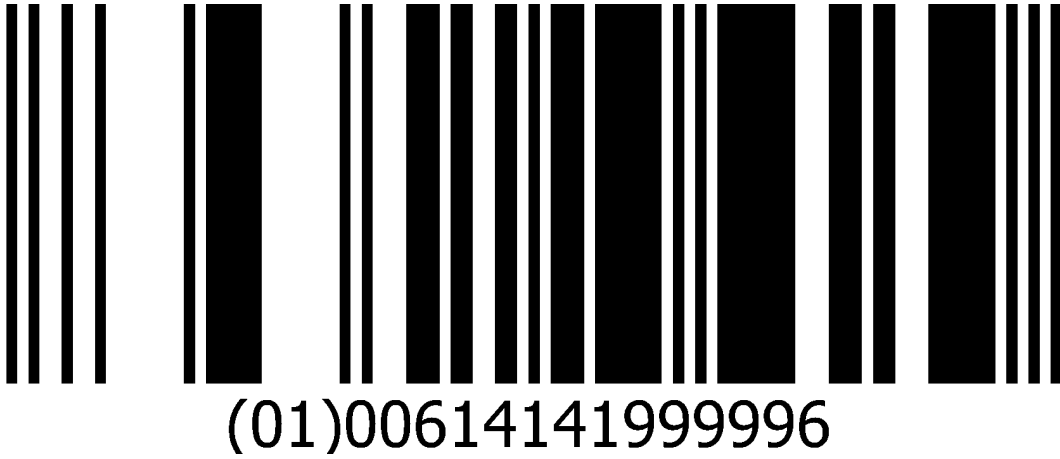

**Sample GS1 DataBar Stacked OmniDirectional**

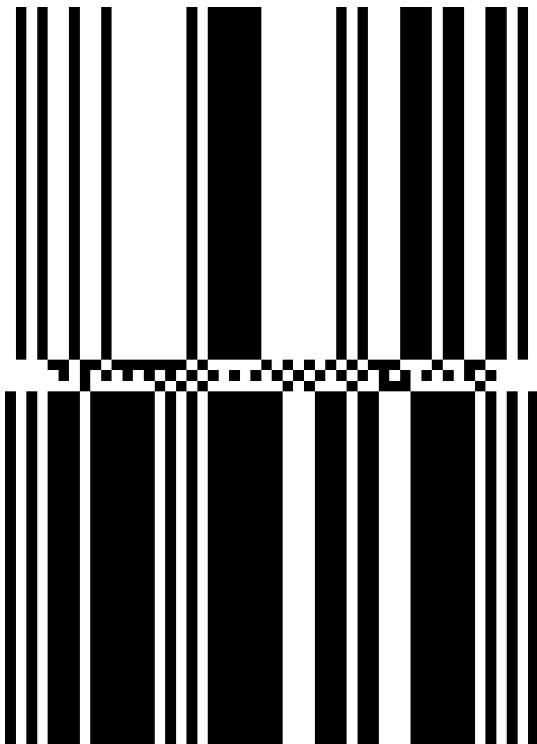

**Sample GS1 DataBar Expanded Stacked Barcode**



**Sample GS1 DataBar Expanded**



**MSI Two Check Digits**



**Sample Code 11 with 2 Check Digits**

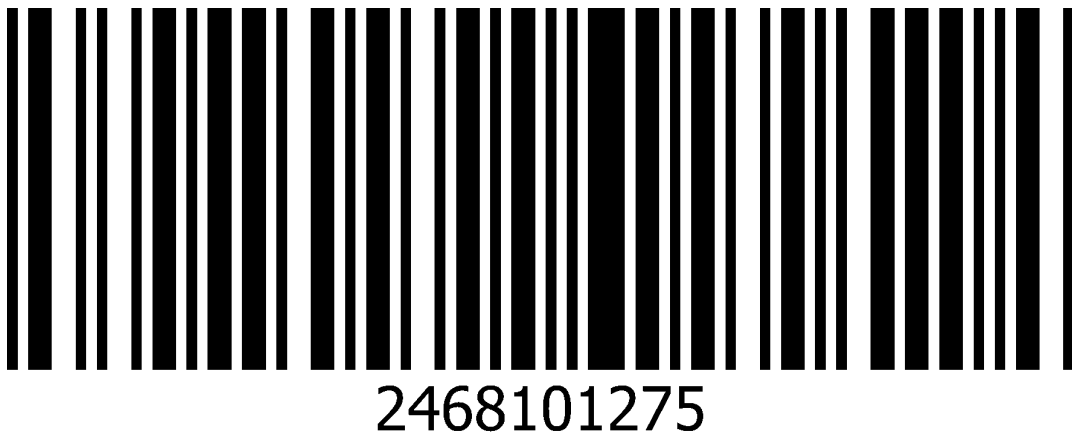

## Sample GS1-128



## 2D Symbologies

The following parameters are specific to 2D Symbologies.

### Sample GS1 Data Matrix

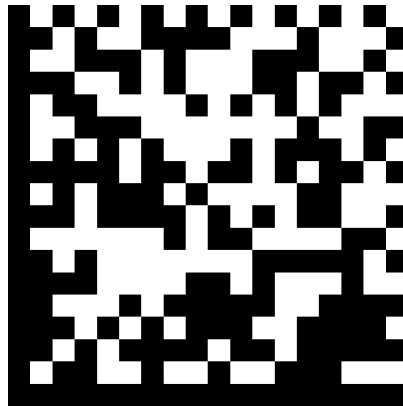

### Sample QR Code

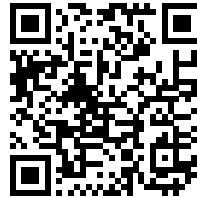

0123456789ABCDEFGHIJKLMNOPQRSTUVWXYZ0123456789ABCDEFGHIJKLMNOPQRSTUVWXYZ012345  
6789

**Sample GS1 QR**



**Sample MicroQR**

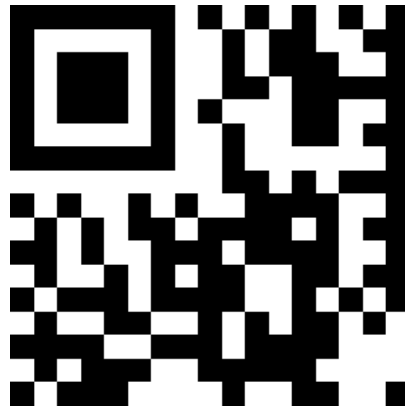

### Sample Han Xin

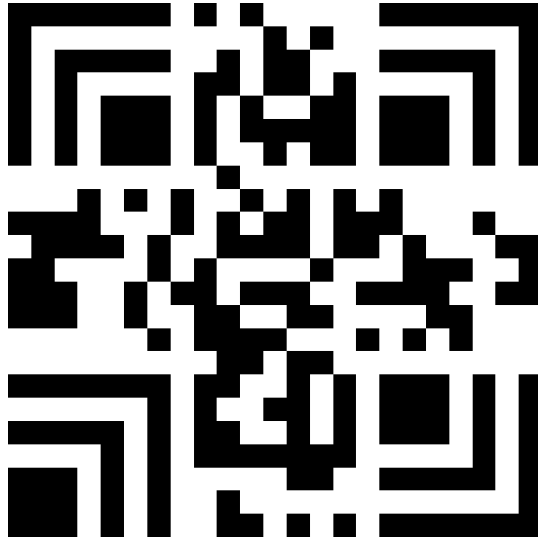

### Sample Grid Matrix



**NOTE:** Grid Matrix must be enabled to read the following bar code (see [Grid Matrix](#)).

