

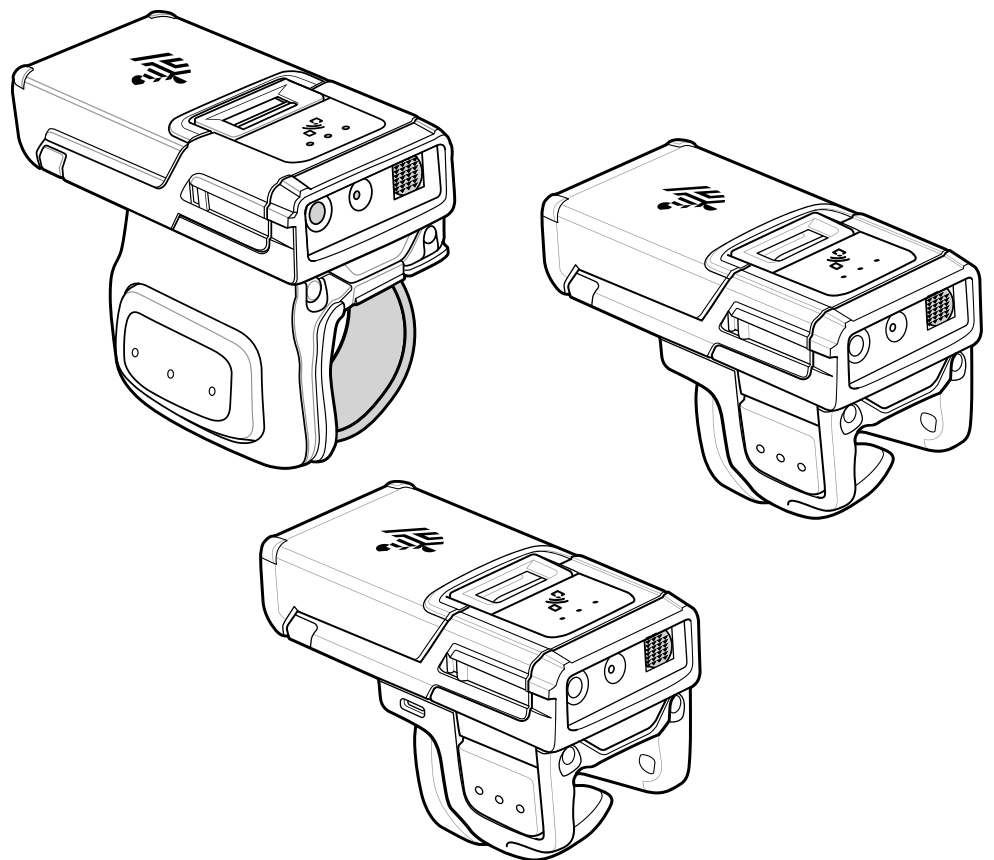


## Leitor Zebra RS5100

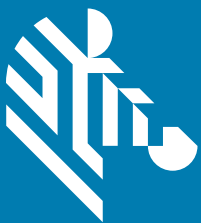
O Leitor Sem Fio Zebra RS5100 permite o escaneamento hands-free que você precisa para maximizar a produtividade. Além de ter um design moderno e compacto, intuitivo que praticamente não requer treinamento e simplicidade de apontar e disparar em qualquer código de barras.

# RS5100

## Bluetooth Ring Scanner



## Product Reference Guide



**ZEBRA**

---

## Copyright

ZEBRA and the stylized Zebra head are trademarks of Zebra Technologies Corporation, registered in many jurisdictions worldwide. . All other trademarks are the property of their respective owners.  
© 2022 Zebra Technologies Corporation and/or its affiliates. All rights reserved.

For further information regarding legal and proprietary statements, please go to:

COPYRIGHTS: [zebra.com/copyright](https://zebra.com/copyright)

WARRANTY: [zebra.com/warranty](https://zebra.com/warranty)

END USER LICENSE AGREEMENT: [zebra.com/eula](https://zebra.com/eula)

---

## Terms of Use

- Proprietary Statement

This manual contains proprietary information of Zebra Technologies Corporation and its subsidiaries (“Zebra Technologies”). It is intended solely for the information and use of parties operating and maintaining the equipment described herein. Such proprietary information may not be used, reproduced, or disclosed to any other parties for any other purpose without the express, written permission of Zebra Technologies.

- Product Improvements

Continuous improvement of products is a policy of Zebra Technologies. All specifications and designs are subject to change without notice.

- Liability Disclaimer

Zebra Technologies takes steps to ensure that its published Engineering specifications and manuals are correct; however, errors do occur. Zebra Technologies reserves the right to correct any such errors and disclaims liability resulting therefrom.

- Limitation of Liability

In no event shall Zebra Technologies or anyone else involved in the creation, production, or delivery of the accompanying product (including hardware and software) be liable for any damages whatsoever (including, without limitation, consequential damages including loss of business profits, business interruption, or loss of business information) arising out of the use of, the results of use of, or inability to use such product, even if Zebra Technologies has been advised of the possibility of such damages. Some jurisdictions do not allow the exclusion or limitation of incidental or consequential damages, so the above limitation or exclusion may not apply to you.

---

## Revision History

Changes to the original guide are listed below:

Change	Date	Description
-09	1/22	Add HID CAPS Lock Override parameter Revised Multipoint-to-Point communication description
-08	11/21	Add Hand Mount Glove
-07	02/21	Add note to battery indications
-06	12/20	Replaced Master/Slave references with Central/Peripheral

Change	Date	Description
-05	08/20	Enhance documentation for support with STB3678
-04	05/20	Add Double-Tigger:USB-C and Double-Trigger:Vibrator
-03	04/20	Add Double-Trigger: Standard and Extended Battery
-02	03/20	Add Auto Un-Pairing
-01	11/19	Initial Release

# Table of Contents

Copyright .....	2
Terms of Use .....	2
Revision History .....	2
<b>About This Guide</b>	
Introduction .....	13
Notational Conventions .....	13
Service Information .....	14
<b>Getting Started</b>	
Introduction .....	15
Unpacking .....	15
Configuration Features .....	16
Status Indications .....	17
RS5100 Activity Modes .....	19
Configurations .....	19
Single Trigger Assembly - Change Trigger Position .....	19
Double Trigger Assembly .....	21
Charge the Battery .....	21
Install the Battery .....	21
Remove the Battery .....	22
Mounting the RS5100 .....	22
Bluetooth Connection .....	24
Scanning .....	24
RS5100 Scanning with SE4710 .....	24
RS5100 Scanning with SE4770 .....	24
Aiming the RS5100 .....	24
Resetting the RS5100 .....	26
Warm Boot .....	26
Cold Boot .....	26
Clean Boot .....	26
<b>123Scan and Software Tools</b>	
Introduction .....	27
123Scan .....	27

## Table of Contents

Communication with 123Scan .....	28
123Scan Requirements .....	28
123Scan Information .....	28
Scanner SDK, Other Software Tools, and Videos .....	28
<b>Bluetooth Communications</b>	
Introduction .....	30
Scanning Sequence Examples .....	30
Errors While Scanning .....	30
Bluetooth Communications Parameter Defaults .....	30
Bluetooth Status Indications .....	32
Bluetooth Connection Modes .....	32
Keyboard Emulation .....	32
HID Bluetooth Classic .....	32
HID Bluetooth Low Energy (Discoverable) .....	32
HID Bluetooth Barcodes .....	33
HID Setup .....	33
HID Options .....	37
Simple Serial Interface (SSI) .....	46
SSI Setup .....	47
Serial Port Profile .....	51
SPP Setup .....	51
Special characters .....	58
General Bluetooth Options .....	65
Default Bluetooth Friendly Name .....	65
Discoverable Mode .....	65
Bluetooth Security .....	66
Wi-Fi Friendly Mode .....	68
Radio Output Power .....	70
Link Supervision Timeout .....	71
Reconnecting .....	72
Pairing Support .....	75
Batch Mode .....	78
Unique Identifier (SPP only) .....	80
Image Capture (SPP only) .....	81
<b>Accessories</b>	
Accessories .....	82
Charging .....	85
Battery Charging .....	86
4-Slot RS5100 Charge Only Cradle .....	88
8-Slot Battery Charger .....	89
20-Slot RS5100 Charge Only Cradle .....	90
40-Slot Battery Charger .....	92
Lanyard Mount .....	93
Back of Hand Mount .....	95
Hand Mount Glove .....	100
Install Glove: Right Hand User .....	100
Install Glove: Left Hand User .....	101

Position Glove on Hand .....	102
Install RS5100 .....	104
Correct Installation .....	105
Incorrect Installation .....	106
Detach RS5100 .....	106
Cleaning the Glove .....	107
<b>RS5100 Configuration and Update</b>	
Introduction .....	109
Configuring the RS5100 .....	109
Introduction .....	109
DataWedge .....	109
123Scan2 .....	110
Real Time Logger .....	110
Retrieving the RS5100 Log File .....	110
RS5100 Firmware Update .....	111
Bluetooth Using 123Scan2 .....	112
Bluetooth Connected Zebra Device .....	112
<b>Miscellaneous Imager Options</b>	
Introduction .....	113
Scanning Sequence Examples .....	114
Errors While Scanning .....	114
User Preferences/Miscellaneous Options Parameter Defaults .....	114
User Preferences .....	116
Default Parameters .....	116
Parameter Barcode Scanning .....	117
Beep After Good Decode .....	118
Beep on Insertion .....	118
Beeper Volume .....	119
Beeper Tone .....	120
Beeper Duration .....	121
Suppress Power Up Beeps .....	121
Low Battery Indication .....	122
Hand-Held Trigger Mode .....	123
Hand-Held Decode Aiming Pattern .....	124
Picklist Mode .....	125
Continuous Barcode Read .....	126
Unique Barcode Reporting .....	127
Decode Session Timeout .....	128
Timeout Between Decodes, Same Symbol .....	129
Timeout Between Decodes, Different Symbol .....	130
Fuzzy 1D Processing .....	130
Decode Mirror Images (Data Matrix Only) .....	131
Mobile Phone/Display Mode .....	132
PDF Prioritization .....	133
PDF Prioritization Timeout .....	134
Decoding Illumination .....	135
Motion Tolerance .....	136

# Table of Contents

Miscellaneous Scanner Parameters .....	136
Add an Enter Key .....	136
Transmit Code ID Character .....	136
Prefix/Suffix Values .....	137
Scan Data Transmission Format .....	138
FN1 Substitution Values .....	140
Transmit “No Read” Message .....	141
Trigger Buttons Enabled .....	141

## Symbologies

Introduction .....	144
Scanning Sequence Examples .....	144
Errors While Scanning .....	144
Symbology Parameter Defaults .....	145
Enable/Disable All Code Types .....	151
UPC/EAN .....	152
Enable/Disable UPC-A .....	152
Enable/Disable UPC-E .....	152
Enable/Disable UPC-E1 .....	153
Enable/Disable EAN-8/JAN-8 .....	153
Enable/Disable EAN-13/JAN-13 .....	154
Enable/Disable Bookland EAN .....	154
Decode UPC/EAN/JAN Supplementals .....	155
User-Programmable Supplementals .....	158
UPC/EAN/JAN Supplemental Redundancy .....	158
UPC/EAN/JAN Supplemental AIM ID Format .....	159
UPC Reduced Quiet Zone .....	160
Transmit UPC-A Check Digit .....	160
Transmit UPC-E Check Digit .....	161
Transmit UPC-E1 Check Digit .....	161
UPC-A Preamble .....	162
UPC-E Preamble .....	163
UPC-E1 Preamble .....	164
Convert UPC-E to UPC-A .....	165
Convert UPC-E1 to UPC-A .....	165
EAN-8/JAN-8 Extend .....	166
Bookland ISBN Format .....	167
UCC Coupon Extended Code .....	168
Coupon Report .....	169
ISSN EAN .....	170
Code 128 .....	171
Enable/Disable Code 128 .....	171
Set Lengths for Code 128 .....	172
Enable/Disable GS1-128 (formerly UCC/EAN-128) .....	174
Enable/Disable ISBT 128 .....	174
ISBT Concatenation .....	175
Check ISBT Table .....	176
ISBT Concatenation Redundancy .....	176
Code 128 Security Level .....	177
Code 128 Reduced Quiet Zone .....	178



## Table of Contents

Ignore Code 128 <FNC4> .....	178
Code 128 Exclusive .....	179
Code 39 .....	180
Enable/Disable Code 39 .....	180
Enable/Disable Trioptic Code 39 .....	180
Convert Code 39 to Code 32 .....	181
Code 32 Prefix .....	182
Set Lengths for Code 39 .....	183
Code 39 Check Digit Verification .....	184
Transmit Code 39 Check Digit .....	184
Code 39 Full ASCII Conversion .....	185
Code 39 Security Level .....	186
Code 39 Reduced Quiet Zone .....	187
Code 39 Buffering - Scan & Store .....	187
Code 93 .....	190
Enable/Disable Code 93 .....	190
Set Lengths for Code 93 .....	190
Code 11 .....	192
Code 11 .....	192
Set Lengths for Code 11 .....	192
Code 11 Check Digit Verification .....	194
Transmit Code 11 Check Digits .....	195
Interleaved 2 of 5 (ITF) .....	196
Enable/Disable Interleaved 2 of 5 .....	196
Set Lengths for Interleaved 2 of 5 .....	197
I 2 of 5 Check Digit Verification .....	199
Transmit I 2 of 5 Check Digit .....	200
Convert I 2 of 5 to EAN-13 .....	200
I 2 of 5 Security Level .....	201
I 2 of 5 Reduced Quiet Zone .....	202
Discrete 2 of 5 (DTF) .....	203
Enable/Disable Discrete 2 of 5 .....	203
Set Lengths for Discrete 2 of 5 .....	204
Codabar (NW - 7) .....	206
Enable/Disable Codabar .....	206
Set Lengths for Codabar .....	206
CLSI Editing .....	208
NOTIS Editing .....	208
Codabar Upper or Lower Case Start/Stop Characters Detection .....	209
Codabar Mod 16 Check Digit Verification .....	209
MSI .....	210
Enable/Disable MSI .....	210
Set Lengths for MSI .....	210
MSI Check Digits .....	212
Transmit MSI Check Digit(s) .....	212
MSI Check Digit Algorithm .....	214
Chinese 2 of 5 .....	215
Enable/Disable Chinese 2 of 5 .....	215
Matrix 2 of 5 .....	216
Enable/Disable Matrix 2 of 5 .....	216
Set Lengths for Matrix 2 of 5 .....	216

## Table of Contents

Matrix 2 of 5 Check Digit .....	218
Transmit Matrix 2 of 5 Check Digit .....	218
Korean 3 of 5 .....	219
Enable/Disable Korean 3 of 5 .....	219
Inverse 1D .....	220
GS1 DataBar .....	221
GS1 DataBar-14 .....	221
GS1 DataBar Limited .....	221
GS1 DataBar Expanded .....	222
Convert GS1 DataBar to UPC/EAN .....	222
GS1 DataBar Limited Security Level .....	223
Composite .....	224
Composite CC-C .....	224
Composite CC-A/B .....	224
Composite TLC-39 .....	225
UPC Composite Mode .....	226
Composite Beep Mode .....	227
GS1-128 Emulation Mode for UCC/EAN Composite Codes .....	227
2D Symbolologies .....	228
Enable/Disable PDF417 .....	228
Enable/Disable MicroPDF417 .....	228
Code 128 Emulation .....	229
Data Matrix .....	230
GS1 Data Matrix .....	230
Data Matrix Inverse .....	231
Maxicode .....	231
QR Code .....	232
GS1 QR .....	232
MicroQR .....	233
Aztec .....	233
Aztec Inverse .....	233
Han Xin .....	234
Han Xin Inverse .....	234
DotCode .....	236
DotCode Inverse .....	237
DotCode Mirrored .....	238
DotCode Prioritize .....	239
Postal Codes .....	240
US Postnet .....	240
US Planet .....	240
Transmit US Postal Check Digit .....	241
UK Postal .....	241
Transmit UK Postal Check Digit .....	242
Japan Postal .....	242
Australia Post .....	243
Australia Post Format .....	244
Netherlands KIX Code .....	245
USPS 4CB/One Code/Intelligent Mail .....	245
UPU FICS Postal .....	246
Mailmark .....	246
Canada Post .....	247

## Table of Contents

Posti LAPA 4-State Code .....	247
Symbology-Specific Security Levels .....	248
Redundancy Level .....	248
Security Level .....	250
1D Quiet Zone Level .....	251
Intercharacter Gap Size .....	252
Report Version .....	252
Macro PDF Features .....	253
Flush Macro Buffer .....	253
Abort Macro PDF Entry .....	253
<b>Digimarc Barcode</b>	
Introduction .....	254
Digimarc Symbology .....	254
Picklist .....	254
Digimarc Digital Watermarks .....	255
<b>Data Formatting: ADF, MDF, Preferred Symbol</b>	
Introduction .....	256
Advanced Data Formatting (ADF) .....	256
Multicode Data Formatting (Hand-held Mode Only) .....	256
Programming a Scanner .....	257
Preferred Symbol .....	257
<b>OCR Programming</b>	
Introduction .....	258
OCR Programming Parameters .....	260
Enable/Disable OCR-A .....	260
OCR-A Variant .....	261
Enable/Disable OCR-B .....	263
OCR-B Variant .....	264
Enable/Disable MICR E13B .....	268
Enable/Disable US Currency Serial Number .....	269
OCR Orientation .....	269
OCR Lines .....	271
OCR Minimum Characters .....	271
OCR Maximum Characters .....	272
OCR Subset .....	272
OCR Quiet Zone .....	273
OCR Template .....	274
OCR Check Digit Modulus .....	283
OCR Check Digit Multiplier .....	284
OCR Check Digit Validation .....	286
Inverse OCR .....	291
OCR Redundancy .....	292

**Maintenance and Troubleshooting**

Introduction .....	293
Maintenance .....	293
Battery Safety Guidelines .....	293
Long Term Storage .....	294
Cleaning Instructions .....	294
Approved Cleanser Active Ingredients .....	294
Harmful Ingredients .....	294
Cleaning Instructions .....	294
Special Cleaning Notes .....	294
Cleaning Materials Required .....	295
Cleaning Frequency .....	295
Cleaning the RS5100 .....	295
Cleaning Cradle Connectors .....	296
Cleaning the Finger Strap and Comfort Pad .....	296
Comfort Pad Replacement .....	297
Trigger Assembly Replacement .....	298
Finger Strap Replacement .....	299
Troubleshooting .....	301
RS5100 .....	301
Cradles .....	302

**Specifications**

RS5100 Technical Specifications .....	303
Cradle Technical Specifications .....	306
4-Slot Charge Only Cradle Technical Specifications .....	306
8-Slot Battery Charger Technical Specifications .....	306
Decode Distances .....	308

**Standard Default Parameters**

Standard Default Parameters Table .....	309
---	-----

**Programming Reference**

Symbol Code Identifiers .....	318
AIM Code Identifiers .....	319

**Alphanumeric and Numeric Barcodes**

Numeric Barcodes .....	324
Cancel .....	325

**Sample Barcodes**

Code 39 .....	343
UPC/EAN .....	343
UPC-A, 100% .....	343
EAN-13, 100% .....	344
Code 128 .....	344

## Table of Contents

Interleaved 2 of 5 .....	344
GS1 DataBar-14 .....	344
PDF417 .....	345
Data Matrix .....	345
Maxicode .....	345
QR Code .....	346
US Postnet .....	346
UK Postal .....	346
<b>Country Codes</b>	
Introduction .....	347
Country Keyboard Types (Country Codes) .....	348
<b>Country Code Pages</b>	
Introduction .....	363
Country Code Page Defaults .....	363
Country Code Page Barcodes .....	367
<b>CKJ Decode Control</b>	
Introduction .....	376
CJK Control Parameters .....	377
Unicode Output Control .....	377
CJK Output Method to Windows Host .....	378
Non-CJK UTF Barcode Output .....	380
Unicode/CJK Decode Setup with Windows Host .....	382
Setting Up the Windows Registry Table for Unicode Universal Output .....	382
Adding CJK IME on Windows .....	382
Selecting the Simplified Chinese Input Method on the Host .....	383
Selecting the Traditional Chinese Input Method on the Host .....	384
<b>ASCII Character Sets</b>	
<b>RSM Attributes</b>	
Attributes for Querying Scanner Information .....	395
<b>Index</b>	

# About This Guide

---

## Introduction

The RS5100 Ring Scanner, also referred to as the Bluetooth Ring Scanner, is a wearable barcode scan solution for both 1D and 2D barcode symbologies. The RS5100 is also compatible with a wide range of mobile computers communicating over Bluetooth.

The RS5100 Product Reference Guide provides additional information that is not covered by the Quick Start Guide and is helpful for application developers and customers alike.

This Product Reference Guide provides information on operating the RS5100 for the first time, using the RS5100, resetting and capturing data.

The guide also covers issues such as charging and testing the RS5100 battery, troubleshooting, maintenance, firmware update and configuration of the RS5100. Sample barcodes are provided for configuring and testing the RS5100.

---

## Notational Conventions

The following conventions are used in this document:

- **Bold** text is used to highlight the following:
  - Dialog box, window and screen names
  - Drop-down list and list box names
  - Check box and radio button names
  - Icons on a screen
  - Key names on a keypad
  - Button names on a screen.
- Bullets (•) indicate:
  - Action items
  - Lists of alternatives
  - Lists of required steps that are not necessarily sequential.
- Sequential lists (e.g., those that describe step-by-step procedures) appear as numbered lists.

---

## Service Information

If you have a problem with your equipment, contact Customer Support for your region. Contact information is available at: [zebra.com/support](http://zebra.com/support).

When contacting support, please have the following information available:

- Serial number of the unit (found on manufacturing label)
- Model number or product name (found on manufacturing label)
- Software type and version number

The following information should be available when reporting a problem:

- Customer name
- Application used
- Configuration
- RS5100 or Cradle version number
- See [Retrieving the RS5100 Log File on page 110](#) to retrieve and E-mail the RS5100 log to the support representative
- Occurrence (always, once out of 10 attempts, etc...)
- Suggested steps to reproduce the problem

Customer Support responds to calls by email or telephone within the time limits set forth in support agreements.

If the problem cannot be solved by Customer Support, you may need to return your equipment for servicing and will be given specific directions. We are not responsible for any damages incurred during shipment if the approved shipping container is not used. Shipping the units improperly can possibly void the warranty.

If the device was purchased from a business partner, contact that business partner for support.

# Getting Started

---

## Introduction

This chapter describes the features of the RS5100 Ring Scanner and explains how to install and charge the battery, capture data and reset the RS5100.

---

## Unpacking

Carefully remove all protective material from around the equipment and save the shipping container for later storage and shipping.

After opening the shipping box, inspect the contents. You should have received the following:

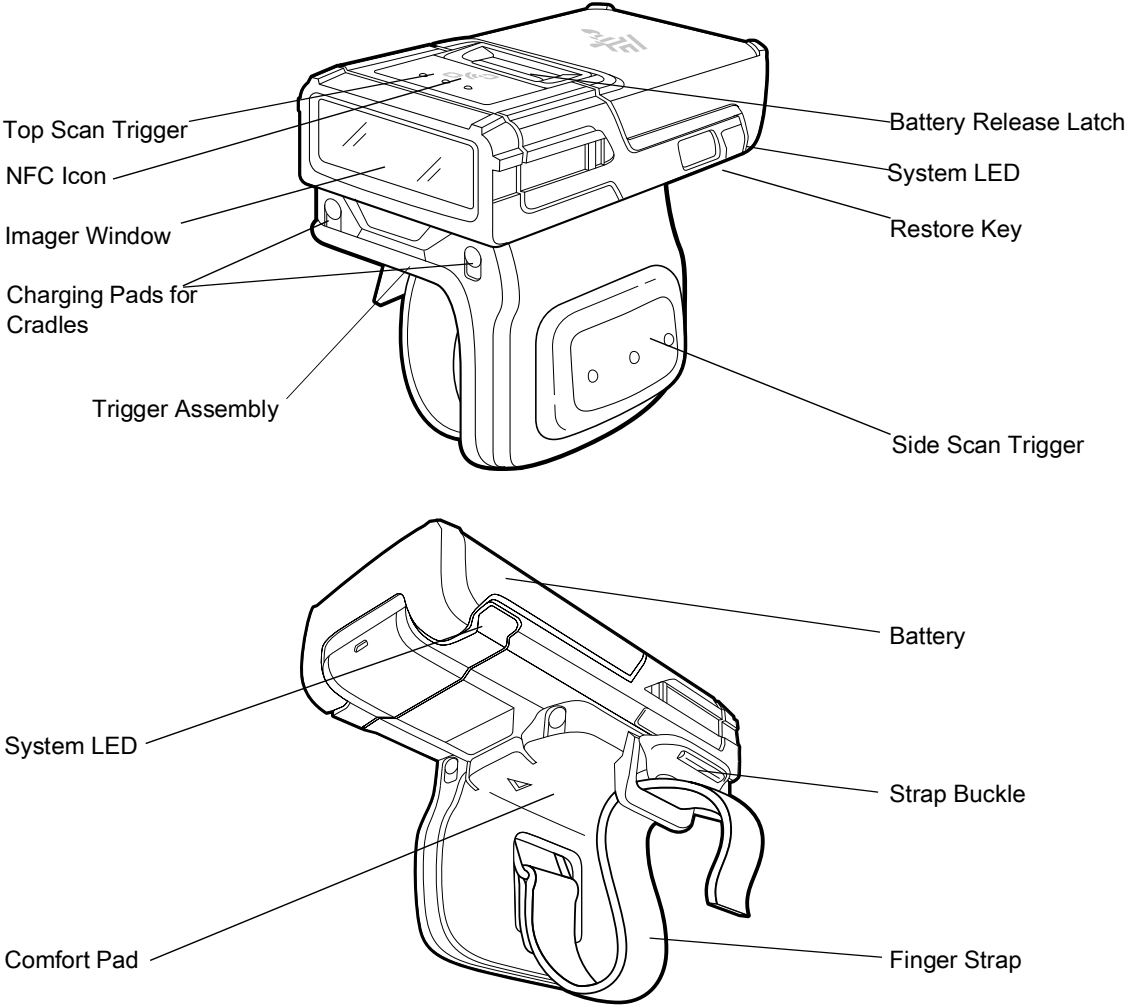
- RS5100
- Battery
- Regulatory Guide
- Optional Trigger Mount Screw in a separate bag.

Inspect the equipment for damage. If you are missing any equipment or if you find any damaged equipment, contact Support immediately. See [Service Information on page 14](#) for contact information.

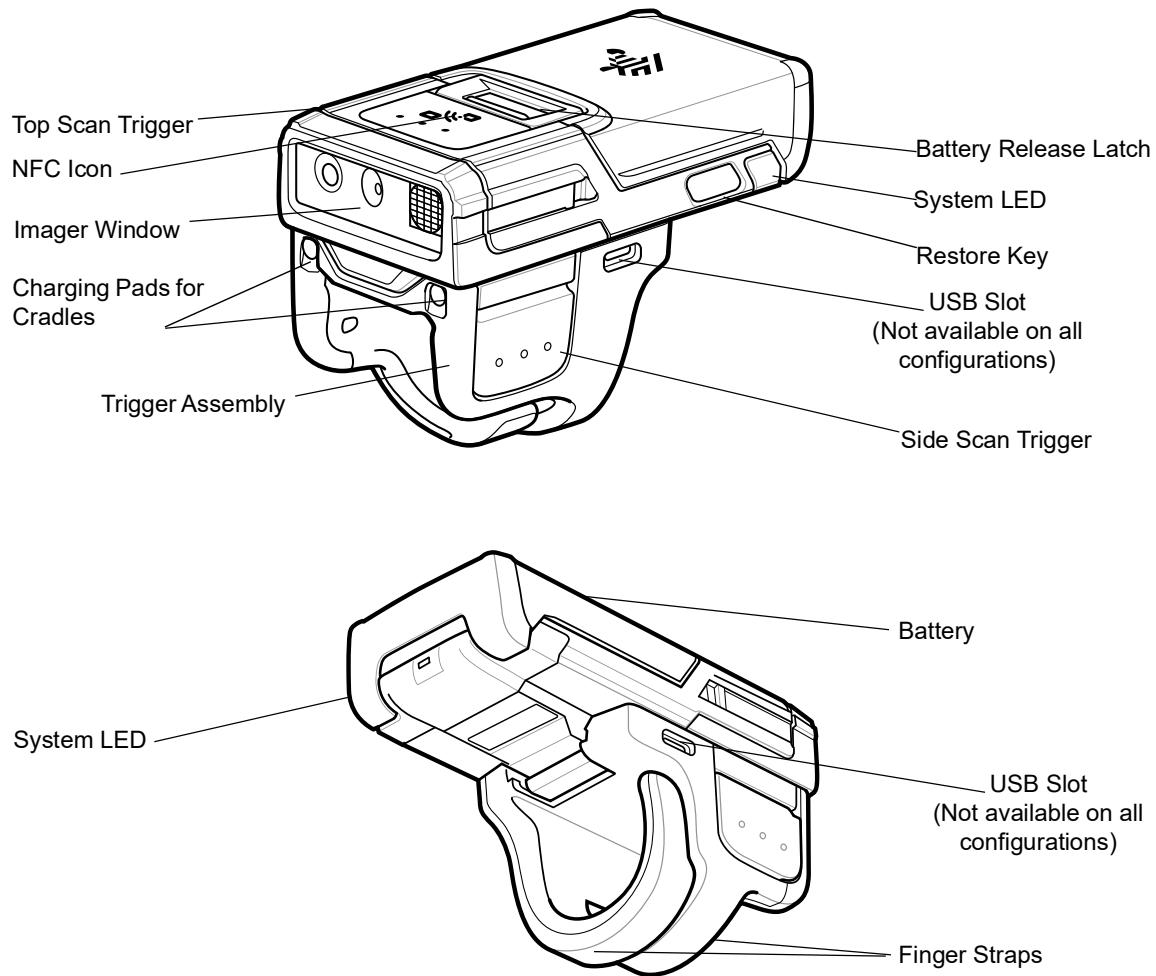


# Configuration Features

Figure 1 RS5100 Single Trigger Configuration Features



**Figure 2** RS5100 Double Trigger Configuration Features



## Status Indications

The RS5100 has System notification LEDs on the back of the device to display system and decode status and a System LED on the top of the device to display Bluetooth and battery status. The RS5100 is also equipped with a beeper that issues different beep sequences and patterns to indicate status. The System LEDs provide identical indications for ambidextrous usage.

[Table 1](#) defines the System LED and beep sequence indications that occur to indicate status.

**Table 1** System LED Indications

LED Type	LED Indication	Beep Indication	Description
<b>Standard Use</b>			
System	Green	Low/Medium/High	Device is powered on.
<b>Scanning Indications</b>			
System	Green single flash	High	A barcode has been decoded

**Table 1** System LED Indications (Continued)

LED Type	LED Indication	Beep Indication	Description
System	Red	4x Low	Transmission error.
System	Red	5x Low	Conversion or format error.
System	Red	Low/High/Low/High	Out of batch memory storage. Unable to store a new barcode.
<b>Radio Indications</b>			
System	Red/Green blinking	6x Short High	Device in paging state.
System	Blue double blink	High/low	Bluetooth communication is disconnected.
System	Blue slow blinking	None	Attempting to reconnect over Bluetooth.
System	None	Low/high	Bluetooth connection established.
System	None	Long low/ long high	Bluetooth connection attempt failed.
System	Blue during beep sequence	Long low/ long high/ Long low/ long high	Bluetooth connection attempt is rejected.
System	Blue slow blinking	5x High	Attempting to reconnect over Bluetooth (disabled by default).
System	Blue blinking	3x Short high	Bluetooth disconnect indication (disabled by default).
<b>Battery Indications</b>			
System	Red	4x Short high	Low battery indicator.
System	Green/Amber/Red	N/A	Battery charge level indication (hold trigger for three seconds to activate). Green is more than 50% Amber is between 20% and 49% Red is less than 20% <b>NOTE:</b> The LED lights up for 3 seconds on the first scan after rebooting the scanner to show battery charge level indication.
System	Red blinking	N/A	Over temperature or bad battery.
<b>Parameter Programming</b>			
System	Red	Long low/long high beeps	Input error, incorrect barcode or <b>Cancel</b> scanned, wrong entry, incorrect barcode programming sequence; remain in program mode.
System	Green	High/low beeps	Keyboard parameter selected. Enter value using barcode keypad.
System	Green	High/low/high/low beeps	Successful program exit with change in the parameter setting.

**Table 1** System LED Indications (Continued)

LED Type	LED Indication	Beep Indication	Description
<b>Maintenance Indications</b>			
System	Green slow blinking		Scanner connected to 123Scan2.
System	Red fast blinking		File being transferred to the scanner (new configuration parameters or firmware) via 123Scan2.
System	Red slow blinking		Firmware installation.
System	Green		Programing completed successfully (parameters change or firmware updated) via 123Scan2.

---

## RS5100 Activity Modes

The RS5100 is capable of three modes of activity:

- **Run Mode** – The RS5100 is scanning or transferring data using Bluetooth.
- **Low Power Mode** – The RS5100 enters Standby mode (Low Power Mode) when it is idle for more than one second. The RS5100 wakes-up and returns to busy (run) mode upon at least one of the following events:
  - Scan trigger
  - Bluetooth activity
  - NFC field detected
  - Press of the Restore key
  - Insert into charging slot
- **OFF Mode** – The RS5100 is not connected to a power source.

---

## Configurations

The RS5100 can be worn with a Single Trigger Assembly or Double Trigger Assembly.



**NOTE:** After installing a different type of trigger, reboot the RS5100 to recognize the new trigger.

### Single Trigger Assembly - Change Trigger Position

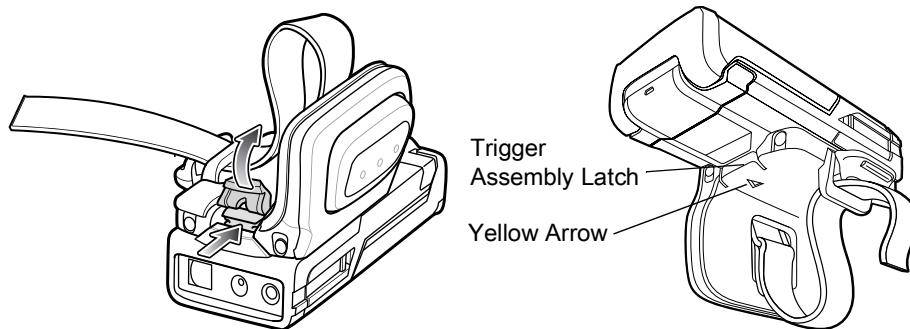
The RS5100 is worn on the index finger, and triggered with the thumb. The Trigger Assembly of the RS5100 is removable to provide left-hand or right-hand use.

To change the position of the trigger:

1. Determine whether the RS5100 is used on the right or left hand and rotate the trigger assembly accordingly, so that the Scan Trigger is positioned next to the thumb when the RS5100 is placed on the index finger.

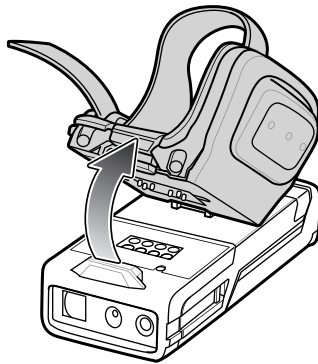
2. Push the Trigger Assembly latch in, while lifting the Trigger Assembly away from the RS5100. Find the side with the arrow on the comfort pad, noting where the yellow latch is.

**Figure 3** Push Trigger Assembly Latch In and Lift



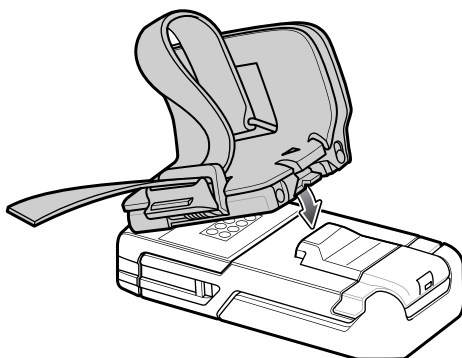
3. Lift the Trigger Assembly off of the RS5100.

**Figure 4** Lift Trigger Assembly Off RS5100



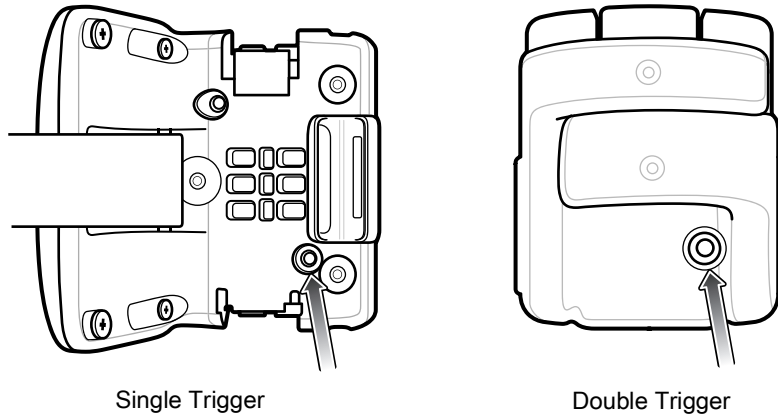
4. Rotate the Trigger Assembly so the Scan Trigger is positioned next to the thumb when the RS5100 is placed on the index finger.
5. Align one end of the Trigger Assembly on the RS5100 and push the other end down until it snaps into place.

**Figure 5** Align Trigger Assembly and Snap Into Place



**NOTE:** An optional Trigger Mount screw is included in the packaging and can be used with a Phillips screwdriver to secure the Trigger Mount when it does not need to be removed or rotated. On the single trigger, the hole for the Trigger Mount screw is under the comfort pad, while on the double trigger the hole is visible from the outside.

**Figure 6** Location of Trigger Mount Screw



## Double Trigger Assembly

The double trigger assembly comes in the following 3 configurations:

- Standard
- USB-C
- Vibrator

The USB-C port on the assembly allows the RS5100 to be charged via a USB cable and also allows for programming using 123Scan.

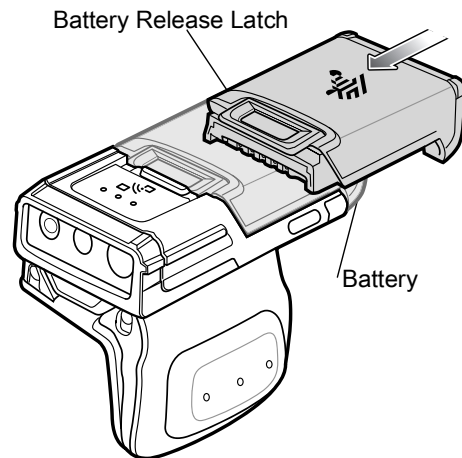
## Charge the Battery

Before using the RS5100, charge the battery. To charge the RS5100 battery, refer to [Accessories](#).

## Install the Battery

1. Align the battery on top of the RS5100 and insert into the battery compartment.

**Figure 7** Install the Battery



2. Slide the battery all the way into the locking slot of the RS5100.
3. Firmly press the battery into the RS5100 until a click is heard ensuring the battery release latch is fully engaged with the RS5100.

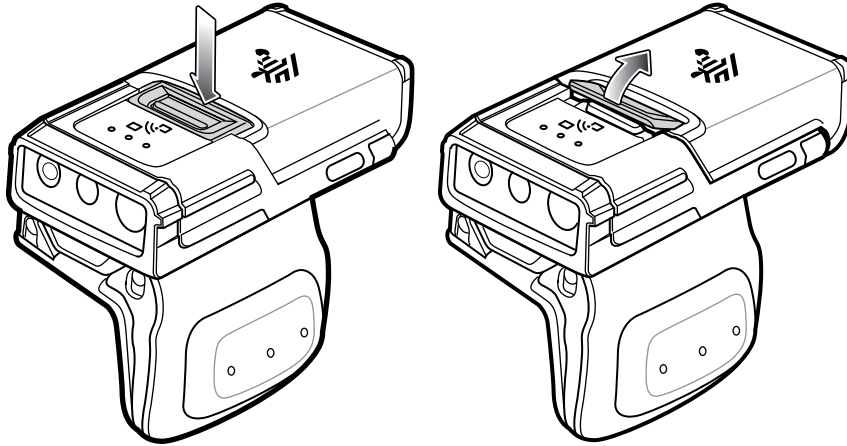


**NOTE:** Brand new batteries from the factory are shipped in Ship Mode for protection, and need to be plugged into a charger (cradle or battery toaster) to activate the battery.

## Remove the Battery

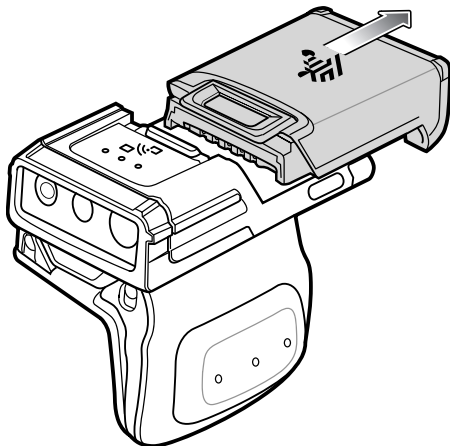
1. Push the battery release latch down until the latch pops up.

**Figure 8** Release Battery



2. Slide the battery out of the battery compartment.

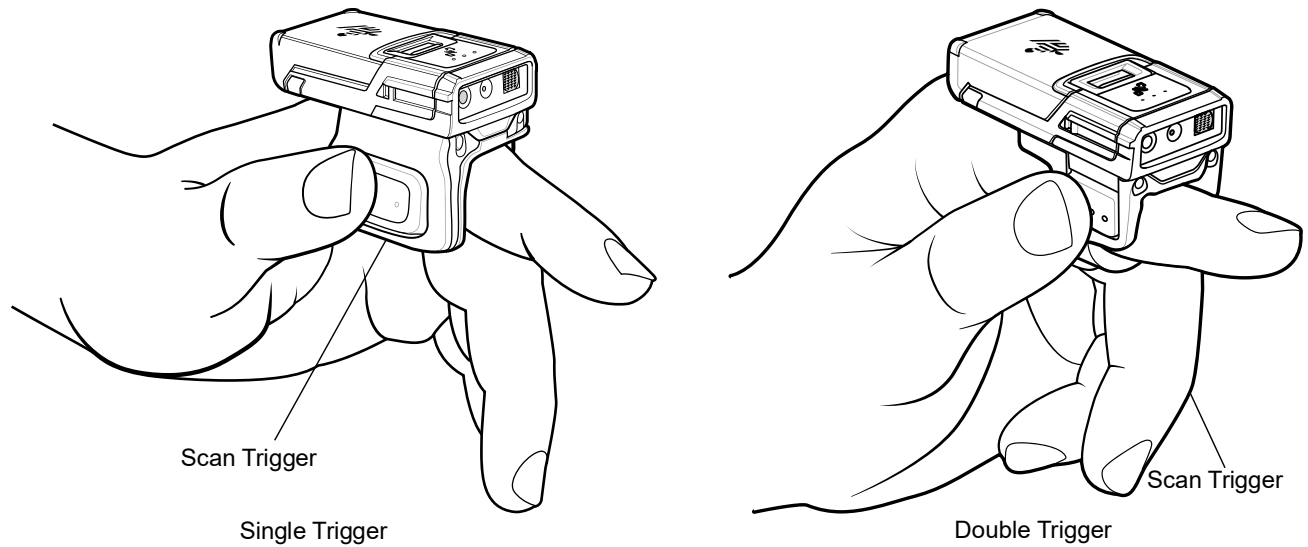
**Figure 9** Remove the Battery



## Mounting the RS5100

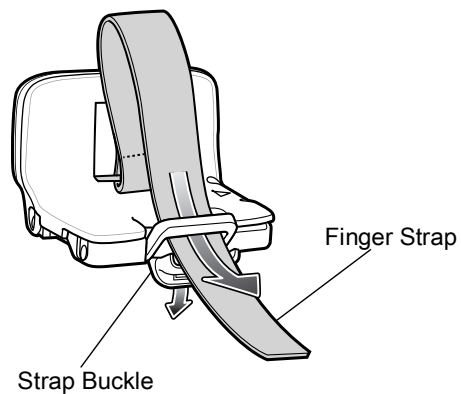
1. Slide the RS5100 onto the index finger with the Scan Trigger next to the thumb.

**Figure 10** Slide RS5100 onto Index Finger



2. To tighten the Finger Strap on the Single Trigger, pull the end of the strap through the Strap Buckle. To loosen the Finger Strap, lift the Strap Buckle away from the Finger Strap while pulling the strap through the Strap Buckle. Release the Strap Buckle to hold the Finger Strap in place.

**Figure 11** Adjust Finger Strap



---

## Powering On

To power on the device:

1. Install the battery (if not already installed).



**NOTE:** Brand new batteries from the factory are shipped in Ship Mode for protection, and need to be plugged into a charger (cradle or battery toaster) to activate the battery.

2. Press one of the following:
  - side scan trigger on the single trigger
  - left side scan trigger on the double trigger
  - scan trigger on the lanyard



- scan trigger on the back of hand mount.

---

## Bluetooth Connection

The RS5100 sends decoded barcode data to Zebra mobile computers and other devices using Bluetooth. Before using, connect the RS5100 to a device using Bluetooth. See [Bluetooth Communications](#) for configuration.

---

## Scanning

The RS5100 uses digital camera technology to take an image of a barcode and software decoding algorithms are executed to extract the barcode data from the image.

### RS5100 Scanning with SE4710

To scan a barcode:

1. Launch a scanning application.
2. Press the Scan Trigger and aim the device at a barcode.
3. Adjust the position of the device so that the orange aiming dot appears at the center of the barcode.

Ensure the barcode is within the area formed by the aiming pattern. The aiming dot is used for increased visibility in bright lighting conditions.

The Status LED illuminates red. Upon successful decode, the Status LED changes from red to green and an audible beep sounds.



**NOTE:** When the device is in Picklist Mode, the imager does not decode the barcode until the crosshair or aiming dot touches the barcode.

4. Release the Scan Trigger.  
The barcode data displays on the screen.

### RS5100 Scanning with SE4770

To scan a barcode:

1. Launch a scanning application.
2. Press the Scan Trigger and aim the device at the barcode.
3. Adjust the position of the device so that the red laser cross-hair appears at the center of the barcode.
4. The status LED illuminates red. Upon successful decode, the status LED changes from red to green and an audible beep sounds.

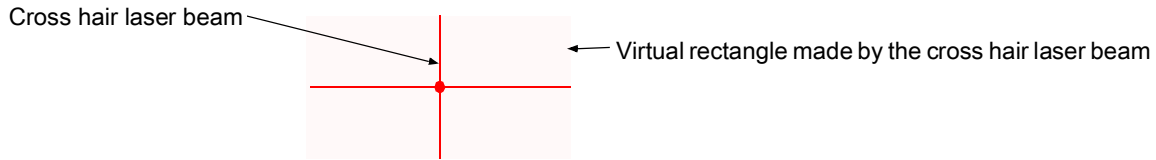


**NOTE:** In some configurations proper decoding of a barcode is indicated by the software application running on the mobile computer.

## Aiming the RS5100

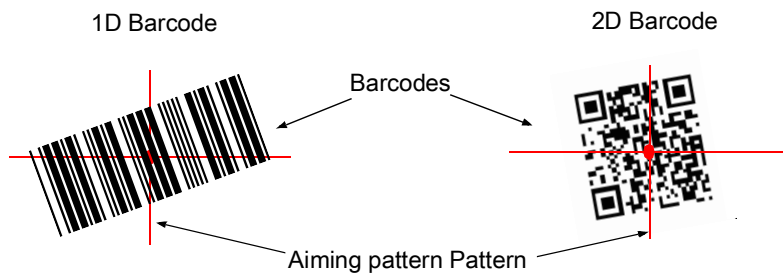
The aiming pattern of the RS5100 is a cross hair laser beam with bright center dot (see [Figure 12](#)). The virtual rectangle made by the cross hair reflects the field of view of the RS5100. The aiming pattern is used to position the barcode within the field of view.

**Figure 12** Cross Hair Laser Beam



Enter the symbol in any orientation within the virtual rectangle made by the cross hair laser beam, making use of its omnidirectional reading capability within the entire field of view.

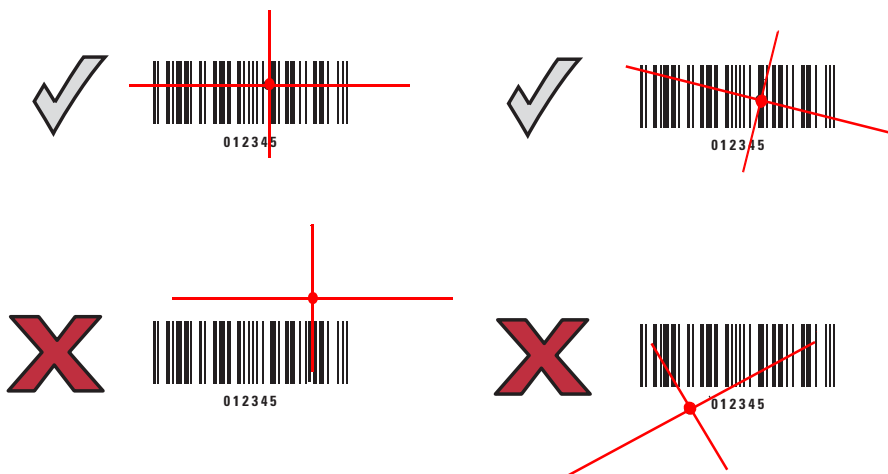
**Figure 13** Barcode Scan Orientation



The RS5100 can also read a barcode presented within the aiming pattern but not centered (see the top barcodes on [Figure 14](#)). The barcodes marked with X in [Figure 14](#), however, show barcode aiming that may result in no decode.

When using the application on your mobile computer in “Pick List” mode, the Bright Center Dot can be positioned anywhere on the symbol (see [Figure 12](#)). The top examples in [Figure 14](#) show acceptable aiming options, while the bottom examples can not be decoded.

**Figure 14** Acceptable Aiming Options



The aiming pattern is smaller when the RS5100 is closer to the symbol and larger when it is farther from the barcode. Scan barcodes with smaller bars or elements (mil size) closer to the RS5100 and those with larger bars or elements (mil size) farther from the RS5100.

1. Position the RS5100 between two and eleven inches from the barcode (depending on the barcode density).



**NOTE:** When a barcode is under transparent plastic or on a mobile computer screen, it is recommended to use a tilt (pitch) or skew scan angle to minimize reflection.

2. Aim the cross hair laser beam to cover the barcode. The RS5100 takes a digital picture (image) of the barcode and stores it in memory for decoding.

The Scan LED flashes green and a high beep sounds indicating that the barcode was properly decoded.

---

## Resetting the RS5100

If the RS5100 stops responding to input, reset it. There are three reset functions, warm boot, cold boot and clean boot. Perform a warm boot first. If the RS5100 still does not respond, perform a cold boot. Perform clean boot to restore the RS5100 to its factory default configuration.

### Warm Boot

To perform warm boot, press and hold the Restore Key for more than three seconds and then release. The RS5100 resets when the key is released.



**NOTE:** A warm boot should be performed to reset the RS5100 after scanning the configuration barcodes.

### Cold Boot

Cold boot restores the RS5100 operation by performing a power cycle of the device. To perform cold boot, remove and re-insert the battery into the RS5100.

### Clean Boot

Clean Boot restores the RS5100 to its factory default configuration.

To perform clean boot:

1. Make sure the battery is inserted and the scanner is turned on.
2. Press and hold the Restore Key until the System LED turns on white.
3. Release the Restore Key and immediately press and hold the Restore Key.
4. Continue to hold the Restore Key until two beeps indicating a Clean Boot are heard and the scanner boot beep sequence is heard. The RS5100 is now in its factory default configuration.

# 123Scan and Software Tools

---

## Introduction

This chapter briefly describes the Zebra software tools available for customizing scanner operation.

---

## 123Scan

123Scan is a software tool that simplifies scanner setup and more.

Intuitive enough for first time users, the 123Scan wizard guides users through a streamlined setup process. Settings are saved in a configuration file that can be printed as a single programming barcode for scanning, emailed to a smart phone for scanning from its screen, or downloaded to the scanner using a USB cable.

Through 123Scan a user can:

- Configure a scanner using a wizard.
  - Program the following scanner settings.
    - Speaker tone / volume settings.
    - Enable / disable symbologies.
    - Communication settings.
  - Modify data before transmission to a host using:
    - Advanced Data Formatting (ADF) - Scan one barcode per trigger pull.
    - Multicode Data Formatting (MDF) - Scan many barcodes in one trigger pull (select scanners).
    - Preferred Symbol - Single out one barcode on label of many (select scanners).
- Load parameter settings to a scanner via the following.
  - Barcode scanning.
    - Scan a paper barcode.
    - Scan a barcode from a PC screen.
    - Scan a barcode from a smart phone screen.
  - Download over a USB cable.
    - Load settings to one scanner.
- Validate scanner setup.
  - Review settings using the Parameter Report.
  - Clone settings from an already deployed scanner from the **Start** screen.

- Upgrade scanner firmware.
  - Load settings to one scanner.
- View statistics such as:
  - Asset tracking information.
  - Time and usage information.
  - Barcodes scanned by symbology.
  - Battery diagnostics (select scanners).
- Generate the following reports.
  - Barcode Report - Programming barcode, included parameter settings, and supported scanner models.
  - Parameter Report - Parameters programmed within a configuration file.
  - Inventory Report - Scanner asset tracking information.
  - Statistics Report - All statistics retrieved from the scanner.



**NOTE:** Data view is not supported.

For more information go to: [www.zebra.com/123Scan](http://www.zebra.com/123Scan).

## Communication with 123Scan

Use a USB cable to connect the scanner to a Windows host computer running 123Scan.

## 123Scan Requirements

- Host computer running Windows XP, 7, 8, and 10
- Scanner
- USB cable.

## 123Scan Information

For more information on 123Scan, go to: [www.zebra.com/123Scan](http://www.zebra.com/123Scan).

For a 1 minute tour of 123Scan, go to: [www.zebra.com/ScannerHowToVideos](http://www.zebra.com/ScannerHowToVideos).

To see a list of all of our software tools, go to: [www.zebra.com/scannersoftware](http://www.zebra.com/scannersoftware).

## Scanner SDK, Other Software Tools, and Videos

Tackle all your scanner programming needs with our diversified set of software tools. Whether you need to simply stage a device, or develop a fully featured application with data capture as well as asset management, these tools help you every step of the way.

To download any of the following free tools, go to: [www.zebra.com/scannersoftware](http://www.zebra.com/scannersoftware).

- 123Scan configuration utility

- SDKs
  - Scanner SDK for Windows
  - Scanner SDK for Android
  - Scanner SDK for iOS
- Drivers
  - OPOS driver (supported over Bluetooth only)
  - USB CDC driver



**NOTE:** Video and SMS are not supported.

- Mobile Apps
  - Scan-To-Connect Utility
    - Android
    - iOS
    - Windows
    - Zebra AppGallery
- How-To-Videos

# Bluetooth Communications

---

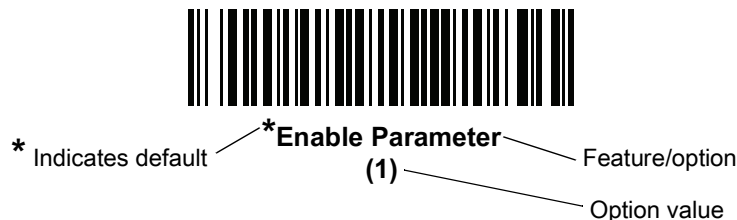
## Introduction

This chapter provides information about the modes of operation and features available for wireless communication between the RS5100 and hosts. The chapter also includes the parameters necessary to configure the RS5100.

The RS5100 ships with the settings shown in the [Bluetooth Communication Defaults on page 31](#) (also see [Standard Default Parameters](#) for all host device and miscellaneous RS5100 defaults). If the default values suit user requirements, programming is not necessary.

To set feature values, scan a single barcode or a short barcode sequence. The settings are stored in non-volatile memory and are preserved even when the RS5100 is powered down.

To return all features to default values, scan a default barcode in [Default Parameters on page 116](#). Throughout the programming barcode menus, default values are indicated with asterisks (\*).



## Scanning Sequence Examples

In most cases, scan one barcode to set a specific parameter value.

## Errors While Scanning

Unless otherwise specified, to correct an error during a scanning sequence, just re-scan the correct parameter.

---

## Bluetooth Communications Parameter Defaults

[Table 2](#) lists the defaults for Bluetooth radio communication parameters. If you wish to change any option, scan the appropriate barcode(s)



**NOTE:** See [Standard Default Parameters](#) for all user preferences, hosts, symbologies, and miscellaneous default parameters.

In this guide, the parameter numbers listed are the same as the attribute numbers for these parameters.

See [Country Codes](#) for Country Keyboard Types (Country Codes).

**Table 2** Bluetooth Communication Defaults

Parameter	Parameter Number	Default	Page Number
Bluetooth Communications Host Types		SSI Bluetooth Classic	
Default BT Friendly Name	1701	Disable	<a href="#">65</a>
Discoverable Mode	610	General	<a href="#">66</a>
Wi-Fi Friendly Mode		Disable	<a href="#">68</a>
Wi-Fi Friendly Channel Exclusion		Use All Channels	<a href="#">69</a>
Radio Output Power	1324	Class 2	<a href="#">70</a>
Link Supervision Timeout	1698	2 Seconds	<a href="#">71</a>
HID Features for Apple iOS	1114	Disable	<a href="#">37</a>
HID Keyboard Keystroke Delay		No Delay (0 msec)	<a href="#">37</a>
HID CAPS Lock Override		Disable	<a href="#">39</a>
HID Ignore Unknown Characters		Enable	<a href="#">40</a>
Emulate Keypad		Disable	<a href="#">40</a>
Fast HID Keyboard	1361	Enable	<a href="#">41</a>
Quick Keypad Emulation	1362	Enable	<a href="#">42</a>
Keyboard FN1 Substitution		Disable	<a href="#">42</a>
Function Key Mapping		Disable	<a href="#">43</a>
Simulated Caps Lock		Disable	<a href="#">43</a>
Convert Case		No Case Conversion	<a href="#">44</a>
Beep on Reconnect Attempt	559	Disable	<a href="#">73</a>
Reconnect Attempt Interval	558	30 sec	<a href="#">73</a>
Auto-reconnect	604	Auto-reconnect Immediately	<a href="#">75</a>
Beep on Insertion	288	Enable	<a href="#">118</a>
Beep on <BEL>	150	Enable	<a href="#">59</a>
Toggle Pairing	1322	Disable	<a href="#">75</a>
Force Pairing Save	795	Enable	<a href="#">76</a>



**Table 2** Bluetooth Communication Defaults (Continued)

Parameter	Parameter Number	Default	Page Number
Auto Un-Pairing	1708	Disable	76
Batch Mode	544	Normal (Do Not Batch Data)	78
Unique Identifier		Disable	80
PIN Code (Set and Store)	552	12345	66
Variable Pin Code	608	Static (Default PIN code is 12345)	67
Bluetooth Security Levels	1393	Low	67

---

## Bluetooth Status Indications

When the RS5100 is pairing or re-establishing a connection to a computer, it issues various beep sequences indicating successful or unsuccessful operations. See [Status Indications on page 17](#) for all beep sequences and LED displays including those which occur during pairing operations.

---

## Bluetooth Connection Modes

The RS5100 can connect to a host computer using the following Bluetooth modes:

- Human Interface Device (HID)
- Simple Serial Interface (SSI)
- Serial Port Profile (SPP).



**NOTE:** Once the RS5100 is paired to a Zebra host device, the scanning software will disable the ability to read the configuration barcodes.

---

## Keyboard Emulation

The Bluetooth Human Interface Device (HID) profile enables the RS5100 to emulate a Bluetooth keyboard input device and connect to a host computer. The RS5100 supports two versions of the Bluetooth HID profile.

### HID Bluetooth Classic

Enables the RS5100 to communicate using Bluetooth HID profile to a host computer through Bluetooth Classic radio. The RS5100 is capable of operating in Peripheral (discoverable) or Central mode.

### HID Bluetooth Low Energy (Discoverable)

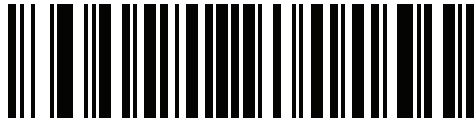
Enables the RS5100 to communicate using Bluetooth HID profile to a host computer through Bluetooth Low Energy radio. The RS5100 operates in Peripheral (discoverable) mode when BT HID Low Energy is enabled.

Low Energy (LE) Bluetooth has a smaller RF footprint (bandwidth) than Classic Bluetooth. The smaller RF footprint of LE Bluetooth significantly improves Wi-Fi co-existence. Due to its smaller RF bandwidth, LE Bluetooth is up to seven times slower than Classic Bluetooth (0.27 Mbps versus 0.7-2.1 Mbps). Data intensive activities such as firmware updates, can take significantly longer.

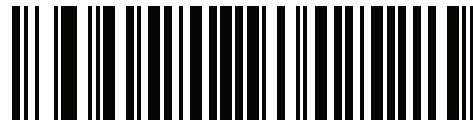


**NOTE:** Not all host devices support Bluetooth Low Energy. Verify that your device supports Bluetooth Low Energy mode before attempting to connect to the RS5100.

## HID Bluetooth Barcodes



**HID Bluetooth Classic**



**HID Bluetooth Low Energy**

## HID Setup

### HID Bluetooth Connection to iOS/iPad/iPhone

1. Perform clean boot. See [Clean Boot on page 26](#)
2. Scan the appropriate HID Bluetooth Barcode from [Table](#) .
3. Perform a Cold Boot by removing and re-installing the battery onto the RS5100. The RS5100 starts to operate and is discoverable as a keyboard.
4. Select **Settings > General > Bluetooth**.
5. Turn Bluetooth **ON**.
6. Select **Bluetooth Settings** and choose RS5100 from the list of discovered devices. The RS5100 displays as RS5100 - xxxxxx, where xxxxxx is the serial number.

### HID Bluetooth Connection to Android

1. Perform clean boot. See [Clean Boot on page 26](#)
2. Scan the appropriate HID Bluetooth Barcode from [Table](#) .
3. Perform a Cold Boot by removing and re-installing the battery onto the RS5100. The RS5100 starts to operate and is discoverable as a keyboard.
4. Select **Settings > Wireless & Networks > Bluetooth**
5. Turn Bluetooth **ON**.
6. Select **Bluetooth Settings** and choose RS5100 from the list of discovered devices. The RS5100 displays as RS5100 - xxxxxx, where xxxxxx is the serial number.



**IMPORTANT:** Some devices may require scanning a PIN to connect. If so, a PIN displays on the device. To enter the required PIN, scan the barcode, [Variable PIN Code on page 67](#) then re-attempt connection. When a beep sounds, indicating the RS5100 is waiting for PIN entry, scan the PIN using the [Alphanumeric and Numeric Barcodes on page 324](#). Incorrect scanned entries can be deleted by scanning [Cancel on page 325](#).

For more information, see [Variable PIN Code on page 67](#).

## HID Bluetooth Connection to Windows 7 or 8



**NOTE:** For best user experience, it is recommend using Secure Simple Pairing (SSP). Windows 7 SP1 supports Bluetooth 2.1 and as such, supports SSP.

SSP reduces the number of steps to minimal or none when compared to legacy Bluetooth pairing.

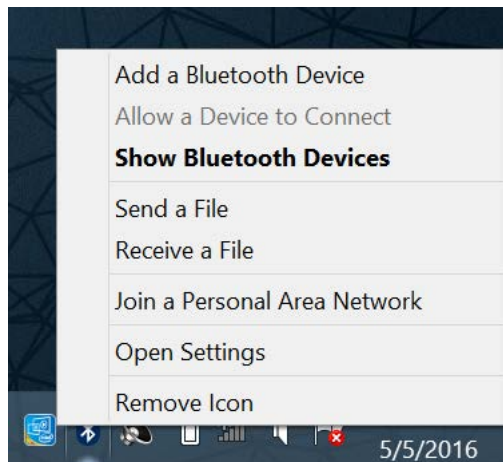
If the host computer does not include an integrated Bluetooth module, use a USB Bluetooth dongle.

Use off-the-shelf dongle that supports Bluetooth v2.1 for effortless pairing in SSP.

To pair and connect the RS5100:

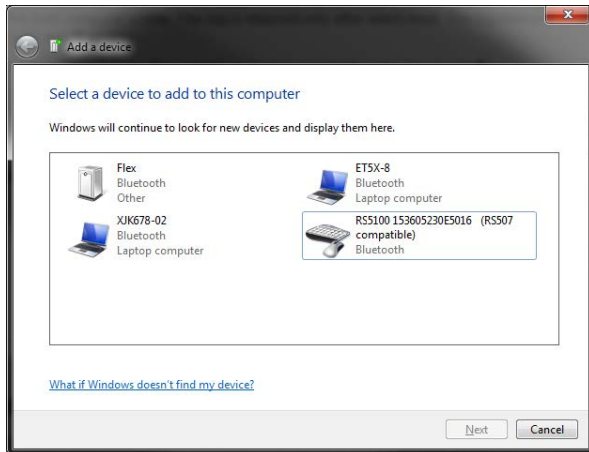
1. Perform clean boot. See [Clean Boot on page 26](#)
2. Scan the HID Bluetooth Classic barcode from page [Table](#) .
3. Perform a Cold Boot by removing and re-installing the battery onto the RS5100. The RS5100 starts to operate and is discoverable as a keyboard.
4. Right click on Bluetooth icon and select **Add a Device** (Windows 7) or **Add a Bluetooth Device** (Windows 8).

**Figure 15** HID - Adding a Device - Windows

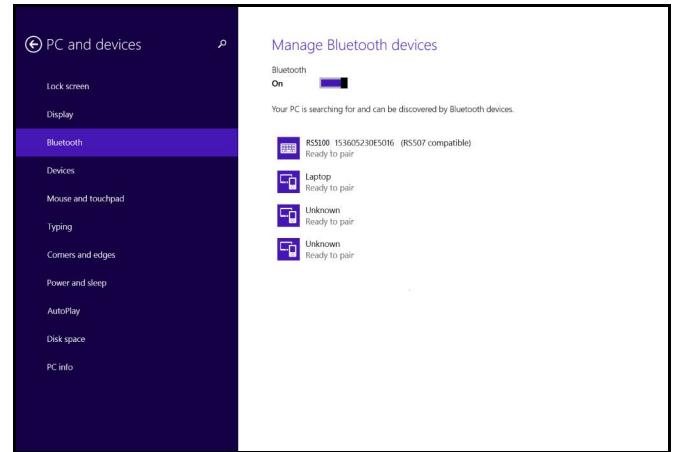


5. From the **Add a device** screen, select the RS5100 (shown as Bluetooth Keyboard) and click **Next**.

**Figure 16** HID - Add Device Screen - Windows



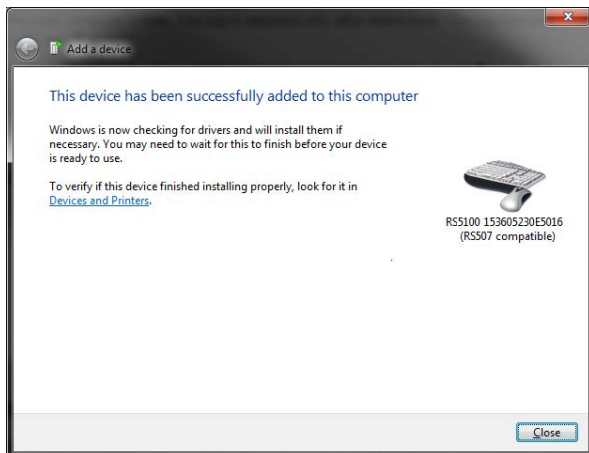
Windows 7



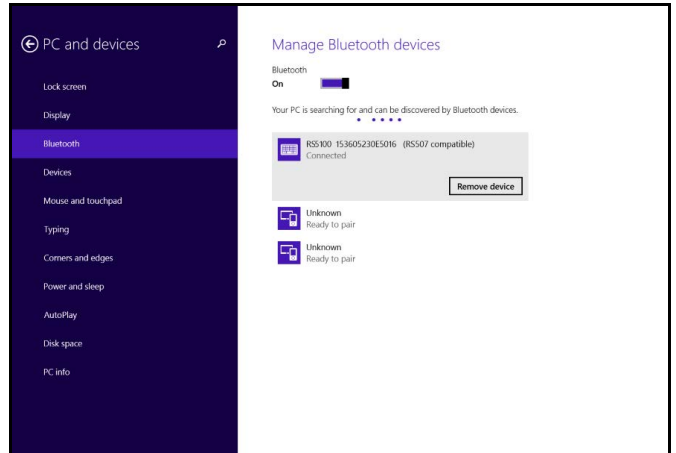
Windows 8

The computer connects to the RS5100 and the following screen displays.

**Figure 17** HID - Device Successfully Added Screen - Windows



Windows 7



Windows 8

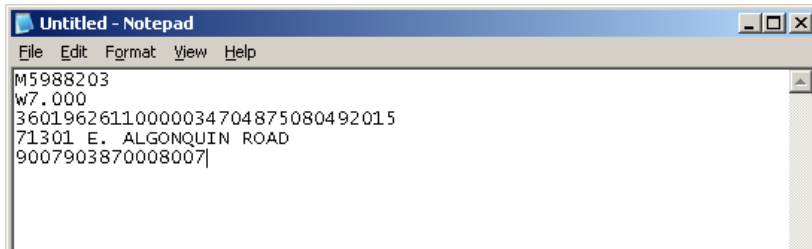
## Demonstrating HID Connection

Following a successful connection, data can be scanned into any Windows, iOS or Android application field that accepts keyboard data; for example, in Windows, the Notepad application.

To scan a barcode:

1. Open the Notepad application.
2. Click in the text area.
3. Scan a barcode. The scanned barcode information displays on the Notepad window.

**Figure 18** HID - Scanned Barcode Information On Notepad Window



## HID Options

The RS5100 supports virtual keyboard emulation for the Apple iOS, and keyboard emulation over the Bluetooth HID profile. In this mode the RS5100 can interact with Bluetooth enabled hosts supporting the HID profile as a Bluetooth keyboard. Scanned data is transmitted to the host as keystrokes.

### HID Features for Apple iOS

#### Parameter # 1114

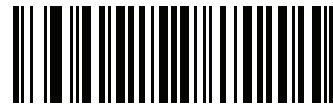
This option works with Apple iOS devices to enable the opening and closing of the iOS virtual keyboard by pressing the Restore key.



**NOTE:** When this feature is enabled, the RS5100 may be incompatible with non-Apple iOS devices.



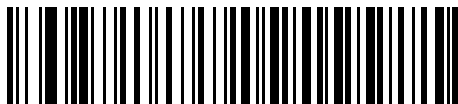
**\*Disable  
(0)**



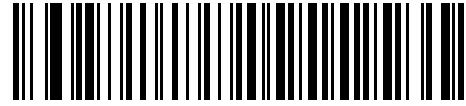
**Enable  
(1)**

### HID Keyboard Keystroke Delay

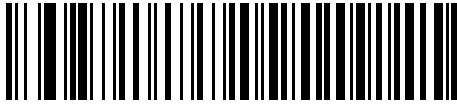
This parameter sets the delay, in milliseconds, between emulated keystrokes. Scan a barcode below to increase the delay when the HID host requires a slower transmission of data.



**\*No Delay (0 msec)**



**Medium Delay (20 msec)**



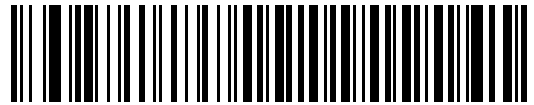
**Long Delay (40 msec)**

## HID CAPS Lock Override

When enabled, the case of the data is preserved regardless of the state of the caps lock key. This setting is always enabled for the “Japanese, Windows (ASCII)” keyboard type and can not be disabled.



**\*Do Not Override Caps Lock Key  
(Disable)**



**Override Caps Lock Key  
(Enable)**



## HID Ignore Unknown Characters

This option applies only to the HID Keyboard Emulation device and IBM device. Unknown characters are characters the host does not recognize. When **Send Barcodes With Unknown Characters** is selected, all barcode data is sent except for unknown characters, and no error beeps sound. When **Do Not Send Barcodes With Unknown Characters** is selected, barcode data is sent up to the first unknown character, then the RS5100 issues an error beep.



**\*Send Barcodes With Unknown Characters  
(Enable)**



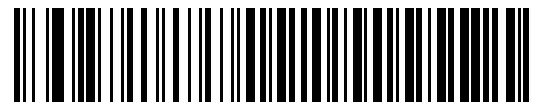
**Do Not Send Barcodes With Unknown Characters  
(Disable)**

## Emulate Keypad

When enabled, all characters are sent as ASCII sequences over the numeric keypad. For example, ASCII A is sent as "ALT make" 0 6 5 "ALT Break."



**\*Enable Numeric Keypad Emulation**



**Disable Numeric Keypad Emulation**

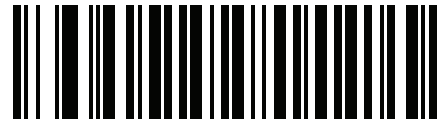
## Fast HID Keyboard

### Parameter # 1361

This option transmits Bluetooth HID keyboard data at a faster rate.



**Fast HID Disable**



**\*Fast HID Enable**

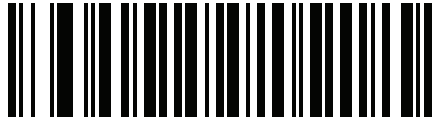
## Quick Keypad Emulation

Parameter # 1362

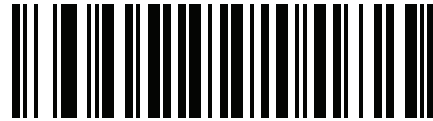


**NOTE:** This option applies only to a HID Keyboard Emulation Device which has **Emulate Keypad** enabled (see [Emulate Keypad on page 40](#)).

This parameter enables a quicker method of keypad emulation where ASCII sequences are only sent for ASCII characters not found on the keyboard.



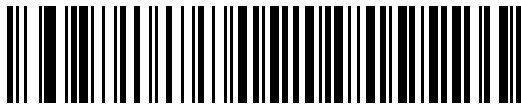
**Quick Keypad Emulation Disable**



**\*Quick Keypad Emulation Enable**

## HID Keyboard FN1 Substitution

When enabled, this parameter allows replacement of any FN1 character in an EAN128 barcode with a Key Category and value chosen by the user. See [FN1 Substitution Values on page 140](#) to set the Key Category and Key Value.



**\*Disable Keyboard FN1 Substitution**



**Enable Keyboard FN1 Substitution**

## HID Function Key Mapping

ASCII values under 32 are normally sent as control-key sequences. When this parameter is enabled, the keys in bold are sent in place of the standard key mapping (see [ASCII Character Sets](#)).

Table entries that do not have a bold entry remain the same whether or not this parameter is enabled.



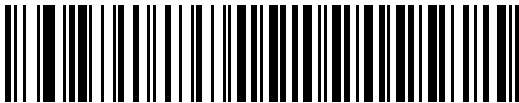
**\*Disable Function Key Mapping**



**Enable Function Key Mapping**

## Simulated Caps Lock

When enabled, the RS5100 inverts upper and lower case characters on the RS5100 barcode as if the Caps Lock state is enabled on the keyboard. This inversion is done regardless of the current state of the keyboard Caps Lock state.



**\*Disable Simulated Caps Lock**



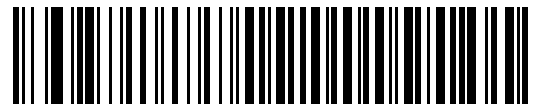
**Enable Simulated Caps Lock**

## Convert Case

When enabled, the RS5100 converts all barcode data to the selected case.



**\*No Case Conversion**



**Convert All to Upper Case**



**Convert All to LowerCase**

## Country Keyboard Type Change

While in HID mode, the RS5100 supports several keyboard layouts.

To change the North American Standard Keyboards layout to a different country code layout, scan the required barcode corresponding to the country keyboard type. See [Country Codes](#) for country keyboard types.

## Simple Serial Interface (SSI)

Select this host type when connecting to a Zebra mobile device or PC/tablet/phone running a Zebra scanner SDK app.

### SSI Bluetooth Classic (Non-discoverable)

This enables the scanner(s) to establish a connection with a Zebra mobile computer over a Bluetooth Classic radio. The scanner is NOT discoverable (Central mode).

To establish a connection (initial setup only), scan the **SSI BT Classic (Non-discoverable)** barcode, and then scan a pairing barcode with the host device's MAC address.



**NOTE:** Additional steps may be necessary depending on host's Bluetooth stack.

### SSI Bluetooth Classic (Discoverable)

This enables communication with Scanner SDK for Android generated apps, and allows the host to establish a connection with the scanner over Bluetooth Classic radio. The scanner is discoverable (Peripheral mode).

To establish a connection (initial setup only), scan the **SSI Bluetooth Classic (Discoverable)** barcode. From the host, discover Bluetooth devices and select the scanner from the discovered device list.

### SSI Bluetooth Low Energy

This enables communication with Scanner SDK for iOS generated apps, and allows the host to establish a connection with the scanner over Bluetooth Low Energy radio. The scanner is discoverable (Peripheral mode).

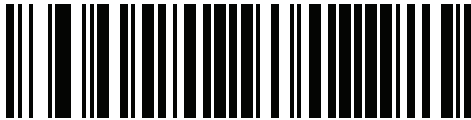
To establish a connection (initial setup only), scan the **SSI Bluetooth Low Energy** barcode. From the host application, select the scanner from the discovered device list.



**SSI Bluetooth Classic (Non-discoverable)**



**SSI Bluetooth Classic (Discoverable)**



**SSI Bluetooth Low Energy**

## SSI Setup

### SSI Bluetooth Connection using NFC

The RS5100 is NFC enabled and supports Bluetooth Tap-to-Pair.

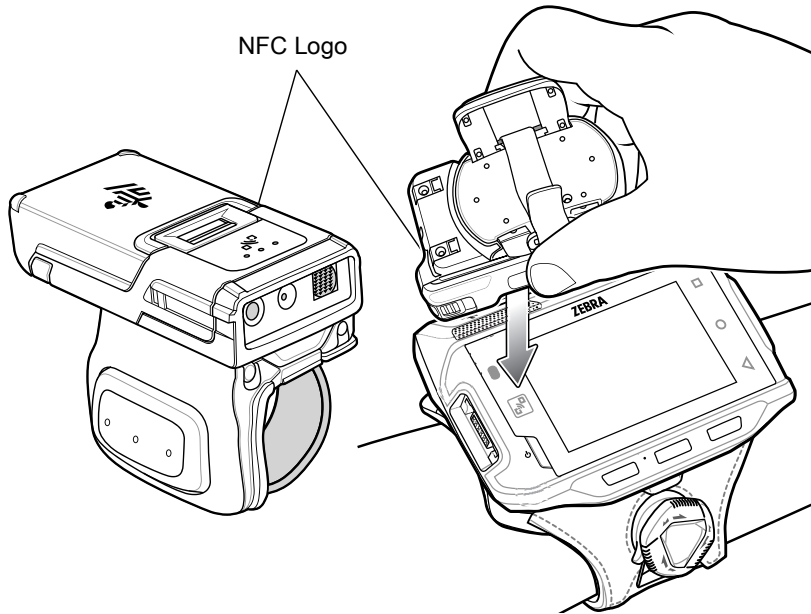
To connect with a WT6000:

1. Check that NFC is enabled on the WT6000.
2. Align the NFC icon of the RS5100 with the NFC icon on the WT6000.

The Status LED blinks blue, indicating that the RS5100 is attempting to establish connection with the WT6000. When connection is established, the Status LED turns off and the RS5100 emits a single string of low/high beeps.



**Figure 19** Touch NFC Antennas



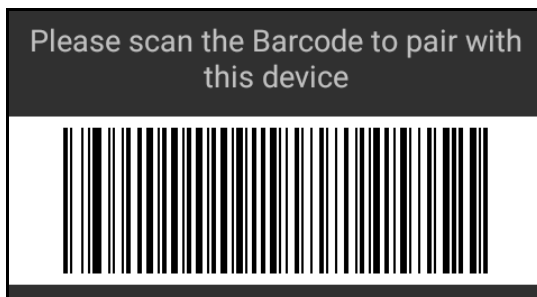
**NOTE:** Not all Zebra device support NFC readers and the Tap-to-Pair feature.

## SSI Bluetooth Connection using Scan2Pair

To pair the RS5100 with the WT6000 using SSI:

1. On the WT6000, touch > . The Bluetooth Pairing Utility opens.

**Figure 20** Bluetooth Pairing Utility



2. Using the RS5100, scan the barcode on the screen.  
The Status LED blinks blue indicating that the RS5100 is attempting to establish connection with the WT6000. When connection is established, the Status LED turns off and the RS5100 emits a single string of low/high beeps.
3. On the WT6000, touch the triangle button to return to the main screen.

## SSI Bluetooth Connection using STB3678 cradle

For information on STB3678 cradle configuration and usage refer to the DS36x8 user guide.

To pair the RS5100 with a STB3678 cradle:

1. Connect the STB3678 cradle to the host computer.
2. Using the RS5100, scan the pairing barcode on the STB3678 cradle.

The Status LED blinks blue indicating that the RS5100 is attempting to establish a connection with the STB3678. When the connection is established, the Status LED turns off and the RS5100 emits a single string of low/high beeps.



**NOTE:** Before pairing the RS5100 with a different device, perform clean boot. See [Clean Boot on page 26](#).

### Point-to-Point Communication

In Point-to-Point communication mode, the cradle allows one digital scanner to connect to it at a time. In this mode, the digital scanner is paired to the cradle by scanning the PAIR barcode. Communication can be locked, unlocked (default), or in a lock override state. In locked mode, locking intervals must be set by scanning a connection maintenance interval barcode.

### Pairing Modes

When operating with the cradle, two modes of pairing are supported:

**Locked Pairing Mode** - When a cradle is paired (connected) to the digital scanner, any attempt to connect a different digital scanner by scanning the PAIR barcode on the cradle is rejected. The currently connected digital scanner(s) maintain connection. In this mode, you must set a Connection Maintenance Interval.

**Unlocked Pairing Mode** - Unlocking works in Point-to-Point mode only. Pair (connect) a new digital scanner to a cradle at any time by either scanning the PAIR barcode on the cradle. This unpairs the previous digital scanner from the cradle.

### Lock Override

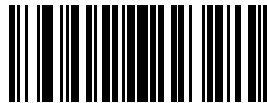
Lock Override overrides a locked digital scanner base pairing and connects a new digital scanner.

## Host Trigger Event Mode

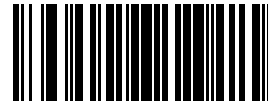
### Parameter #790

RS5100 is compatible with the STB3678 cradle and apps that utilize Zebra Scanner SDK, as well as Zebra host terminals apps that use EMDK. However, appropriate host trigger event mode has to be selected when partnering with those devices. RS5100 selects appropriate mode automatically, based on the pairing barcode, but it can be also manually set in case an appropriate pairing barcode is not used.

Use Host Trigger Event disabled mode for pairing with STB3678 cradle or Zebra Scanner SDK apps and utilities running on Windows, Android, or Apple iOS.



**\*Host Trigger Event Mode Enabled**



**Host Trigger Event Mode Disabled**

## Serial Port Profile

Select this host type when connecting to a PC/tablet/phone using a Bluetooth serial connection.

### SPP BT Classic (Non-discoverable)

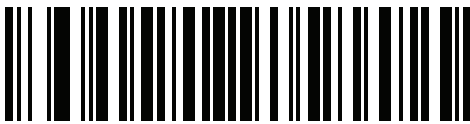
This enables the scanner to establish an SPP connection with the host over Bluetooth Classic radio. The scanner is not discoverable (Central mode).

To establish a connection (initial setup only), scan the **SPP BT Classic (Non-discoverable)** barcode, and then scan a pairing barcode with the MAC address of the host device.

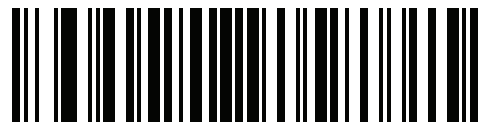
### SPP BT Classic (Discoverable)

This enables the host to establish an SPP connection with the scanner over Bluetooth Classic radio. The scanner is discoverable (Peripheral mode).

To establish a connection (initial setup only), scan the **SPP BT Classic (Discoverable)** barcode. From the host, discover Bluetooth devices and select the scanner from the discovered device list.



**SPP Bluetooth Classic (Non-discoverable)**



**SPP Bluetooth Classic (Discoverable)**



**NOTE:** Since the SPP connection does not support automatic acknowledgment when the data is received by the computer application, a BELL indication is used.

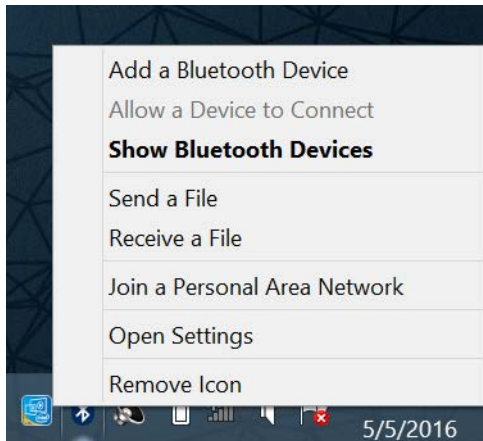
The BELL indication allows the computer application to send single binary character 0x07 to the RS5100 (as defined in ASCII table). Upon receiving the BELL character, the RS5100 beeps. To configure the beep, see [Bell Indication Control on page 59](#).

## SPP Setup

### SPP Bluetooth Connection to Windows 7 or 8 as Central

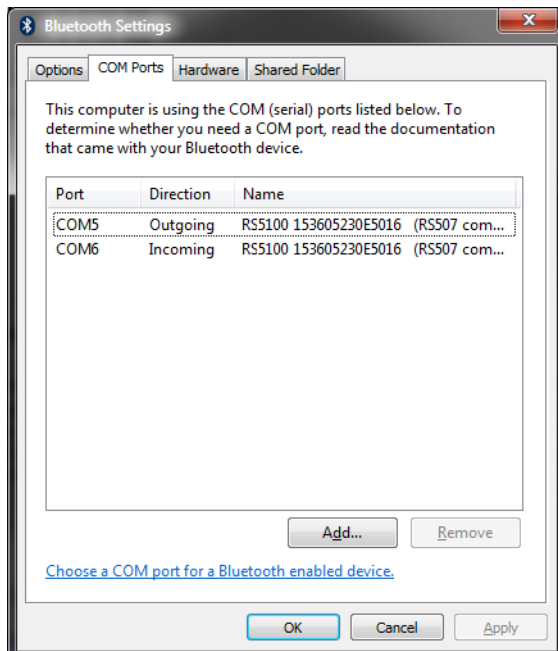
1. Perform clean boot. See [Clean Boot on page 26](#).
2. Scan the SPP Bluetooth Classic (Non-Discoverable) barcode.
3. Perform a Cold Boot by removing and re-installing the battery onto the RS5100. The RS5100 starts to operate and is discoverable as a Bluetooth serial device.
4. Right click on the Bluetooth icon and select **Open Setting** to add a COM port

**Figure 21** SPP - Open Setting Screen - Windows

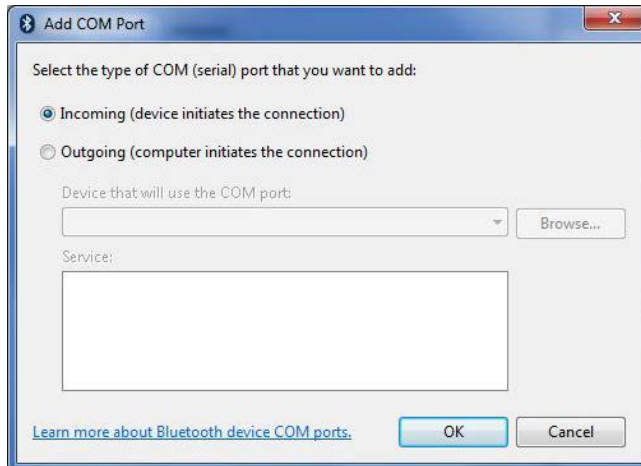


5. Select the **COM Ports** tab and click **Add**.

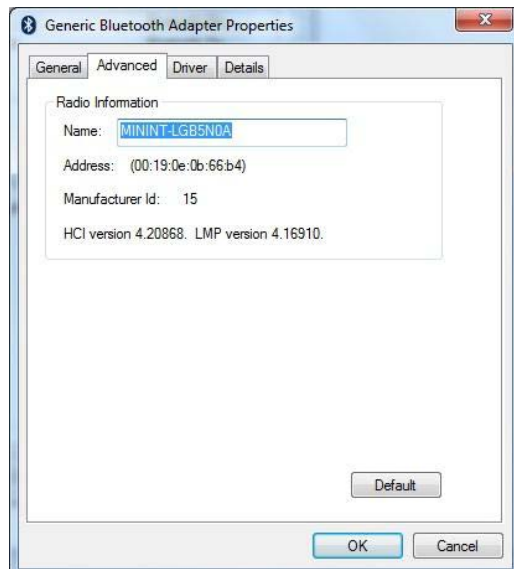
**Figure 22** SPP - Bluetooth Settings - Com Ports Tab



6. Select the **Incoming** radio button and click **OK**.

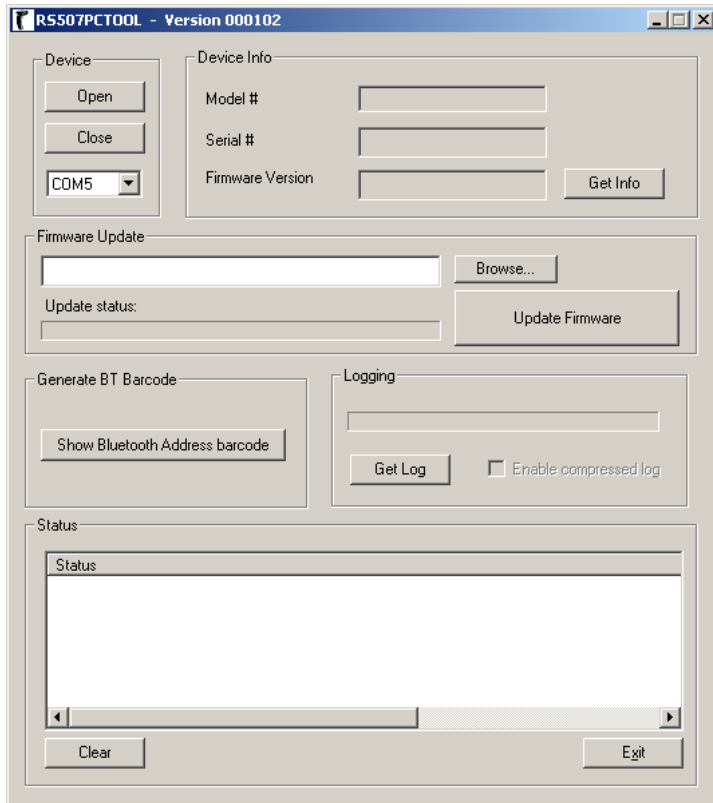
**Figure 23** SPP - Bluetooth Settings - Add Com Port Screen

7. Click the **Hardware** tab.
8. Click the **Properties** button.
9. Click the **Advanced** tab to retrieve the Bluetooth radio BD address in the **Address** field.
10. Click **OK**.

**Figure 24** SPP - Bluetooth Settings - Bluetooth Radio BD Address

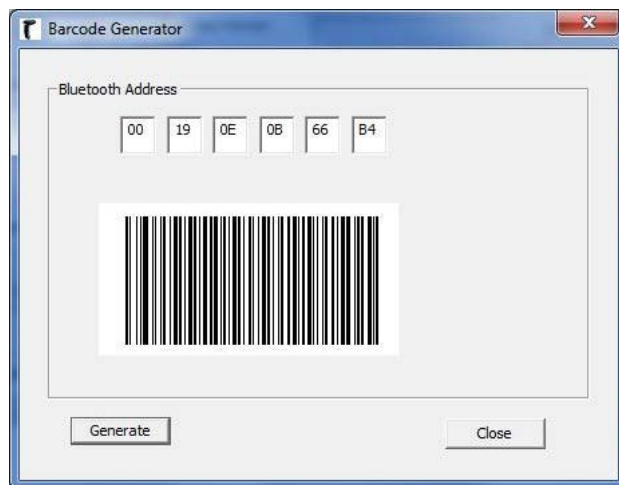
11. Run the PC Tool application.

**Figure 25** SPP - PC Tool application



12. Click the **Show Bluetooth Address barcode** button.
13. Manually enter the BD address to the PC Tool application and click the **Generate** button.

**Figure 26** SPP - PC Tool Application - Barcode Generator



14. Click **Close**.
15. Open the incoming COM port assigned (for example, COM7) in the application. After the COM port is opened the computer connects to the RS5100 and a beep will sound. For demonstration, refer to [General Bluetooth Options on page 65](#).

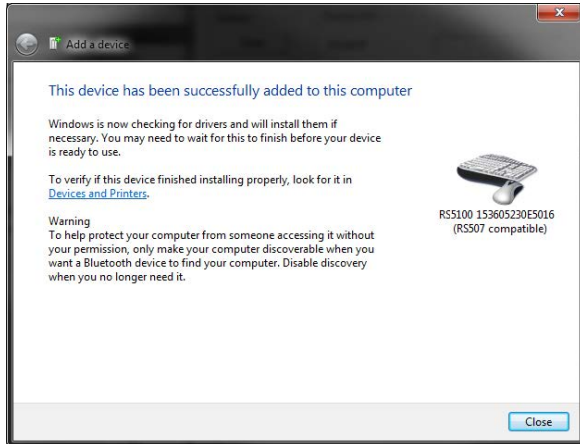


**NOTE:** If the COM port is not opened prior to the connection, the RS5100 will fail to connect.

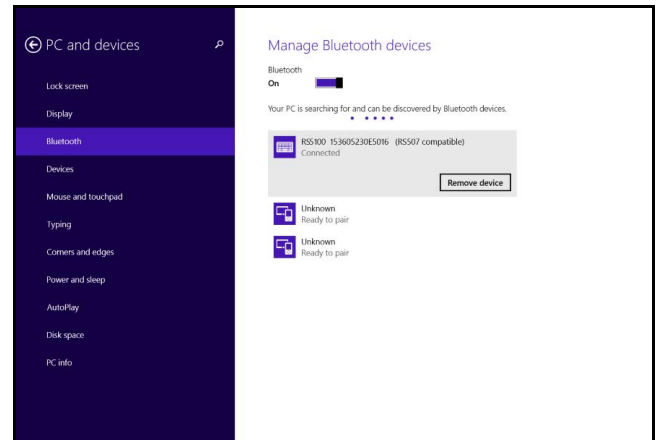
16. To start the connection process aim the RS5100 at about 7" (18 cm) away from the computer screen and scan the barcode of the BD address of the computer (or the other target device).

The RS5100 Scan LEDs start flashing green indicating that the RS5100 is attempting to establish connection with the computer. The following notifications display upon successful connection.

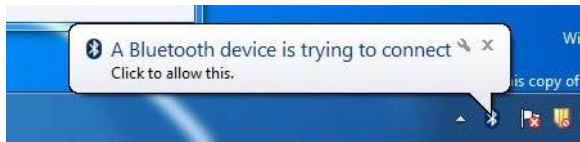
**Figure 27** SPP - Device Successfully Added Screen



Windows 7



Windows 8



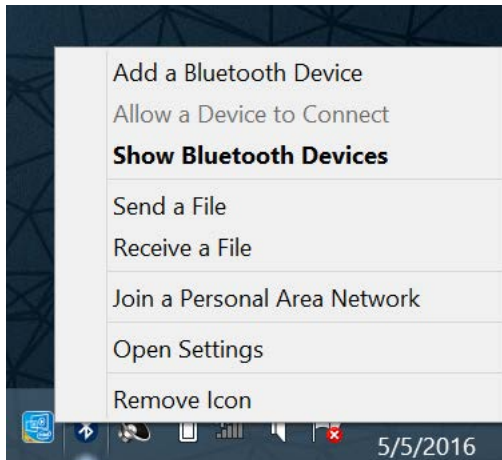
**NOTE:** In case you do not hear the connected beep on the RS5100, press the RS5100 **Restore key** to connect.

## SPP Bluetooth Connection to Windows 7 or 8 as Peripheral

1. Perform clean boot. See [Clean Boot on page 26](#).
2. Scan the SPP Bluetooth Classic (discoverable) barcode.
3. Perform a Cold Boot by removing and re-installing the battery onto the RS5100. The RS5100 starts to operate and is discoverable as a Bluetooth serial device.
4. Right click the Bluetooth icon and select **Add a Device** (Windows 7) or **Add a Bluetooth Device** (Windows 8).

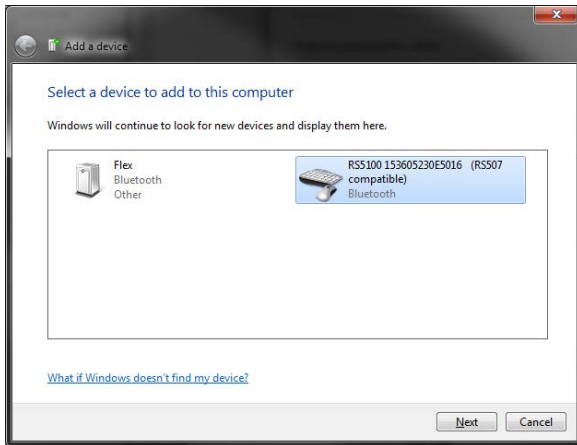


**Figure 28** SPP connection with RS5100 as a Peripheral - Open Settings

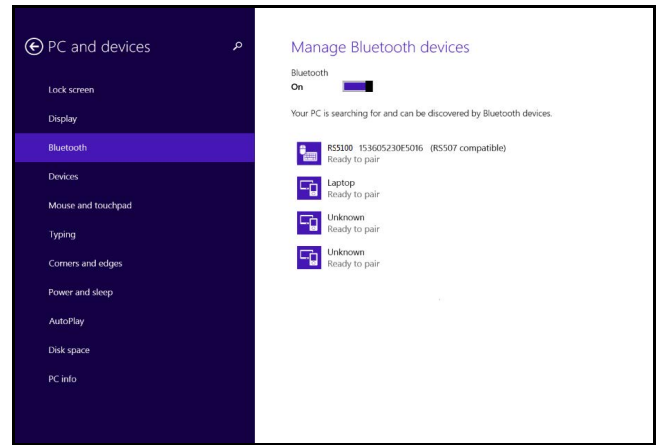


5. Select the RS5100 (see Bluetooth Camera icon below) and click **Next**

**Figure 29** SPP connection with RS5100 as a Peripheral - Add Device Screen



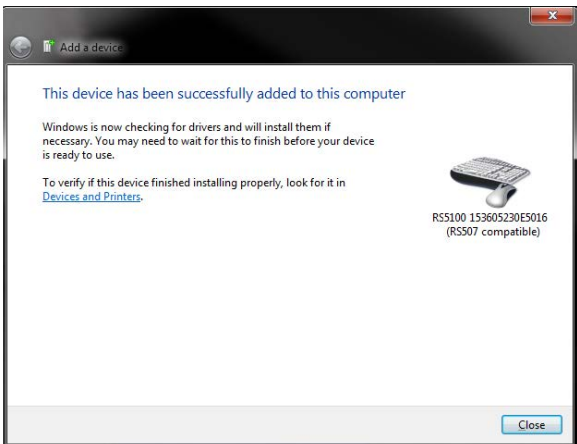
Windows 7



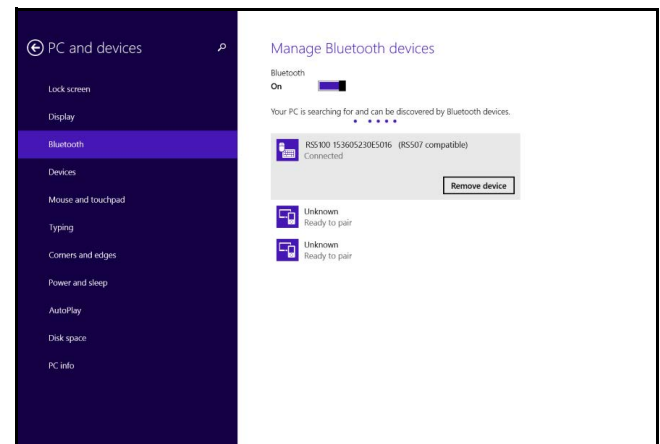
Windows 8

6. The computer attempts to connect to the RS5100

**Figure 30** SPP connection with RS5100 as a Peripheral - Device Successfully Added Screen



Windows 7



Windows 8

7. Open the incoming COM port assigned (for example, COM7) in the application. After the COM port is opened the computer connects to the RS5100 and a beep will sound. For demonstration, refer to [General Bluetooth Options on page 65](#).



**NOTE:** Make sure the same COM port is closed in other applications.

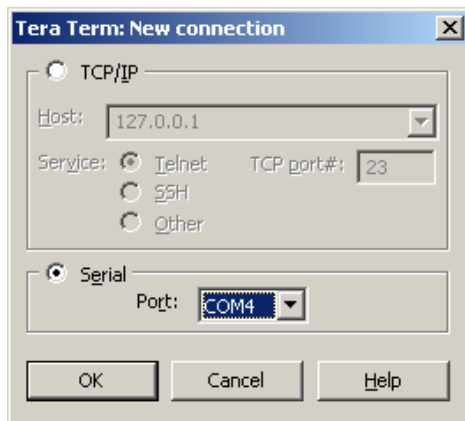
## How to Demonstrate SPP Connection with a Computer

Once SPP connection is established, an application is required to demonstrate the RS5100.

To scan a barcode:

1. If the RS5100 is still connected to the PC Tool application, close the COM port on the PC Tool application.
2. Run a hyper terminal application such as the Tera Term application. ([ayera.com/teraterm/download.cfm](http://ayera.com/teraterm/download.cfm)).

**Figure 31** Tera Term Application Screen



3. Select the virtual COM port set for the RS5100 connection.
4. Scan barcodes. Successful decoding of a barcode is indicated by one green flash of the **Scan LEDs** and a high beep sound. In case of Bluetooth disconnection, the RS5100 emits one high beep followed by four low beeps.

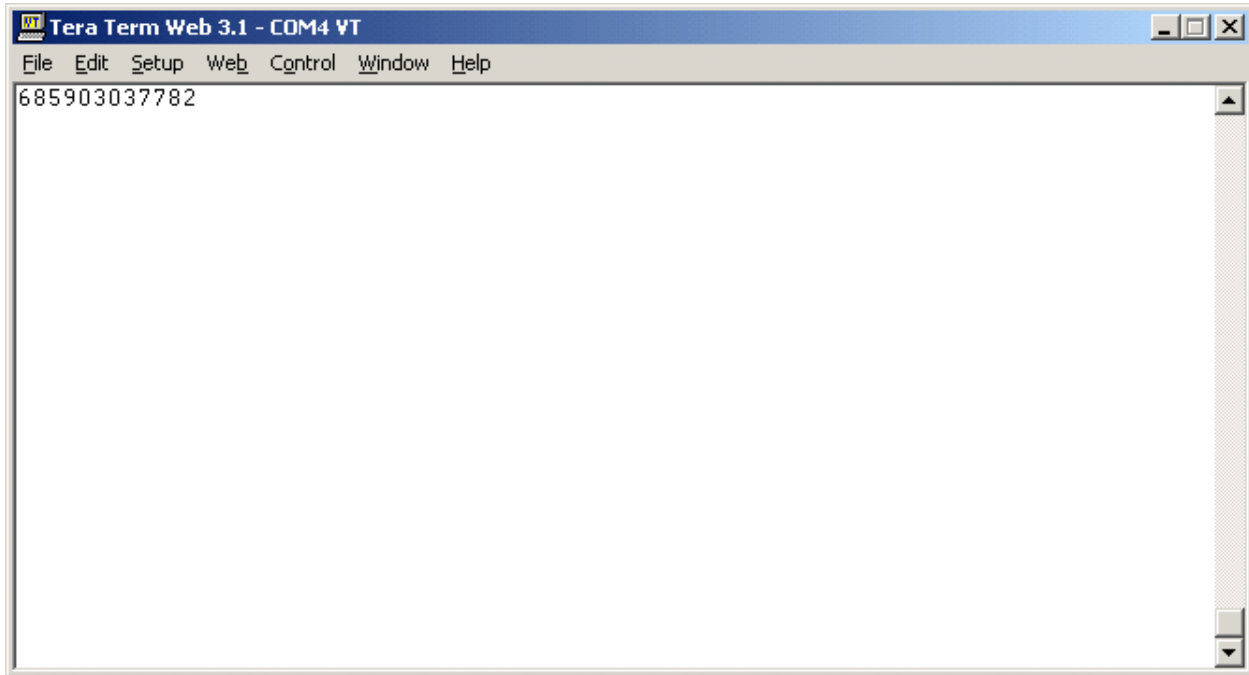


Figure 32 Tera Term Entry Screen

## Special characters

SPP mode supports special characters that trigger actions when sent from the computer.

Table 3 Special Characters

Character	ASCII	Action
BELL	0x07	If Bell Indication is enabled, performs the configured Bell Indication.
Serial	0x73	Sends the serial number of the RS5100.
Image Capture Mode	0x69	Activates Image Capture mode.
Custom notification 1	0x79	Performs custom notification sequence 1.
Custom notification 2	0x63	Performs custom notification sequence 2.
Scanner enable	0x65	Enables scanner.
Scanner disable	0x64	Disables scanner.

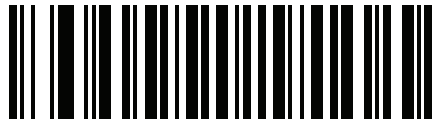
## Beep on BELL Character

### Parameter # 150

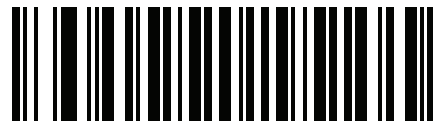
When this parameter is enabled, the RS5100 issues a beep when a <BEL> character is received over the SPP connection to the host device.



**NOTE:** This parameter only applies to SPP (Serial Port Profile).



**\*Beep on <BEL> Enable**



**Beep on <BEL> Disable**

## Bell Indication Control

The BELL Indication Control parameter configures the beep tone sequence of the bell indication when a BELL character is received. This feature is valid only in SPP mode for PC connection.



**GP\_1\_HI\_SHORT**



**GP\_2\_HI\_SHORT**



GP\_3\_HI\_SHORT



GP\_4\_HI\_SHORT



GP\_5\_HI\_SHORT



GP\_1\_LO\_SHORT



GP\_2\_LO\_SHORT



GP\_3\_LO\_SHORT



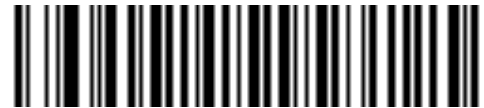
GP\_4\_LO\_SHORT



GP\_5\_LO\_SHORT



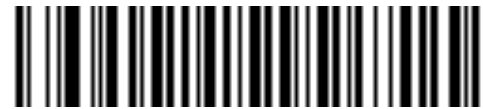
GP\_1\_HI\_LONG



GP\_2\_HI\_LONG



GP\_3\_HI\_LONG



GP\_4\_HI\_LONG



GP\_5\_HI\_LONG



GP\_1\_LO\_LONG



GP\_2\_LO\_LONG



GP\_3\_LO\_LONG



GP\_4\_LO\_LONG



GP\_5\_LO\_LONG



GP\_FAST\_WARBLE



GP\_SLOW\_WARBLE



GP\_HI\_LO



GP\_LO\_HI



GP\_HI\_LO\_HI



GP\_LO\_HI\_LO



GP\_HI\_HI\_LO\_LO



APP\_ERROR\_BEEP



APP\_CLICK



LOW\_CLICK





## General Bluetooth Options

### Default Bluetooth Friendly Name

#### Parameter # 1701

Select default Bluetooth Friendly Name.

- Select **RS5100** for pairing with Host device, in SSI mode, that supports RS5100. The Friendly Name becomes **RS5100 <serial number>**.
- Select **RS5100 and RS6000** for pairing with old Host device, in SSI mode, that does not support RS5100. The Friendly Name becomes **RS5100 <serial number> (RS6000 compatible)**



**NOTE:** When you change this parameter, the RS5100 needs to be rebooted.



**NOTE:** If RS5100 is already paired to a Host device in 'RS5100' mode that doesn't have RS5100 support, then after you change the parameter to 'RS5100 and RS6000' mode, you need to reboot the Host device and pair again before it can function properly.



**\*RS5100  
(0)**



**RS5100 and RS6000  
(1)**

### Discoverable Mode

#### Parameter # 610

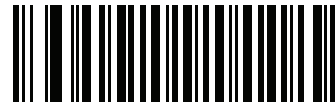
Select a discoverable mode based on the device initiating discovery:

- Select **General Discoverable Mode** when initiating connection from a PC.
- Select **Limited Discoverable Mode** when initiating connection from a PC or mobile device, and the RS5100 does not appear in General Discoverable Mode. Note that it can take longer to discover the device in this mode.

The RS5100 remains in Limited Discoverable Mode for 30 seconds, and the blue LED flashes while in this mode. It is then non-discoverable. To re-activate Limited Discoverable Mode, press the trigger.



**\*General Discoverable Mode  
(0)**



**Limited Discoverable Mode  
(1)**

## Bluetooth Security

The RS5100 supports Bluetooth authentication. Authentication can be requested by either the remote device or the RS5100.



**NOTE:** A remote device can still request authentication.

### PIN Code

Parameter # 552



**NOTE:** The default PIN code is 12345.

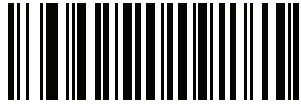
To set and store a PIN code (e.g., password) on the RS5100 to connect to the host:

1. Scan the **Set & Store PIN Code** barcode below.
2. Scan five alphanumeric programming barcodes using the alphanumeric barcodes beginning on page [324](#).
3. Scan **End of Message** on page [332](#).

If the RS5100 communicates with a remote device with security enabled, synchronize the PIN codes on the RS5100 and remote device. To achieve this, connect the RS5100 to the host when setting the PIN codes. If the RS5100 is not connected to a host, the PIN code change only takes affect on the RS5100. If is required between the RS5100 and host, and the PIN codes do not match, pairing fails.



**NOTE:** An extended 16 character PIN code is available for additional security with Open Bluetooth (SPP and HID).



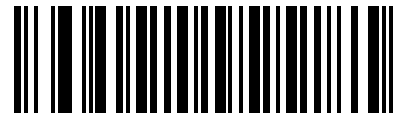
**Set and Store PIN Code**

## Variable PIN Code

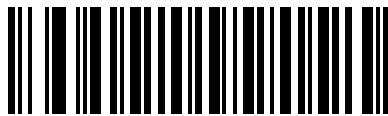
### Parameter # 608

When connecting to a host device with authentication enabled, scan **Static PIN Code** below to avoid entering the PIN code manually. The PIN stored in memory is used. Scan the **Variable PIN Code** below to manually enter a PIN code with each connection.

The default PIN code is the user-programmed PIN set and stored above. Typically, however, HID connections require entering a Variable PIN Code. If, when attempting connection, the application presents a text box that includes a PIN, scan the **Variable PIN Code** barcode, then re-attempt connection. When you hear a beep indicating the RS5100 is waiting for an alphanumeric entry, enter the provided variable PIN using the [Alphanumeric and Numeric Barcodes on page 324](#), then scan **End of Message** on page 332 if the code is less than 16 characters. The RS5100 discards the variable PIN code after connection.



**\*Static PIN Code  
(0)**



**Variable PIN Code  
(1)**

## Bluetooth Security Levels

### Parameter # 1393

- **Low Bluetooth Security** - The low security setting is designed for ease of connection with most devices. This setting may be unacceptable to some devices. If connection fails, try re-connecting after increasing security setting on the RS5100.

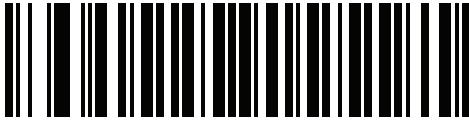
If connecting to Bluetooth 2.1 device and above, Just Works method for secure and simple pairing is used.



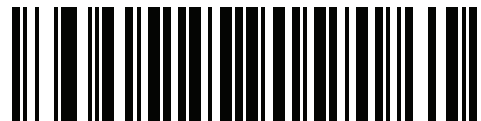
**NOTE:** Data is encrypted using the **Low Bluetooth** security setting if connected to a Bluetooth 2.1 and above device.

- **Medium Bluetooth Security** - The medium security setting may require a passkey for the initial connection to pair RS5100 and device. If connecting to Bluetooth 2.1 device and above, *Passkey Entry* method for secure and simple pairing is used.

- **High Bluetooth Security** - The high security setting enables *Man in the Middle* protection for Bluetooth 2.1 and above. Not all devices are able to support this mode.
- **Legacy Bluetooth Security** (Bluetooth 2.0 and below) - The legacy security setting enables authentication and encryption for legacy pairing.



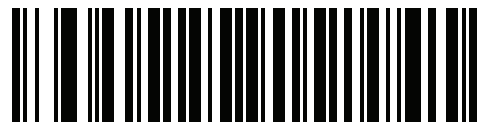
**\*Low Bluetooth Security**



**Medium Bluetooth Security**



**High Bluetooth Security**



**Legacy Bluetooth Security**

## Wi-Fi Friendly Mode

Scanners configured for Wi-Fi friendly mode behave as follows:

- The RS5100 remains in sniff mode, and exits sniff mode only during firmware update.
- If any Wi-Fi channel is excluded from the hopping sequence, AFH turns off.
- RS5100 avoid the selected Wi-Fi channels after establishing connection.

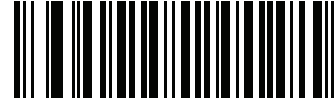
### Notes

- If using this feature, configure all RS5100 in the area for Wi-Fi friendly mode.
- By default, no Wi-Fi channels are excluded.
- Since Bluetooth requires a minimum of 20 channels when Wi-Fi channels 1, 6, and 11 are excluded, a smaller number of channels are cut from the hopping sequence.
- Updating Wi-Fi friendly settings before Bluetooth connection is recommended.

Scan a barcode below to enable or disable **Wi-Fi Friendly Mode**, then see [Wi-Fi Friendly Channel Exclusion](#) to select any channels to exclude.



**\*Disable Wi-Fi Friendly Mode**

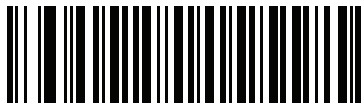


**Enable Wi-Fi Friendly Mode**

## Wi-Fi Friendly Channel Exclusion

Select the channels to exclude:

- **Exclude Wi-Fi channel 1:** Bluetooth channels 0-21 are excluded from hopping sequence (2402-2423 MHz).
- **Exclude Wi-Fi channel 6:** Bluetooth channels 25-46 are excluded from hopping sequence (2427 - 2448 MHz).
- **Exclude Wi-Fi channel 11:** Bluetooth channels 50-71 are excluded from hopping sequence (2452 - 2473 MHz).
- **Exclude Wi-Fi channel 1, 6 and 11:** Bluetooth channels 2-19 (2404-2421 MHz), 26-45 (2428 - 2447 MHz) and 51-69 (2453 - 2471 MHz) are excluded from hopping sequence.
- **Exclude Wi-Fi channels 1 and 6:** Bluetooth channels 0-21 (2402-2423 MHz) and 25-46 (2427 - 2448 MHz) are excluded from hopping sequence.
- **Exclude Wi-Fi channels 1 and 11:** Bluetooth channels 0-21 (2402-2423 MHz) and 50-71 (2452 - 2473 MHz) are excluded from hopping sequence.
- **Exclude Wi-Fi channel 6 and 11:** Bluetooth channels 25-46 (2427 - 2448 MHz) and 50-71 (2452 - 2473 MHz) are excluded from hopping sequence.



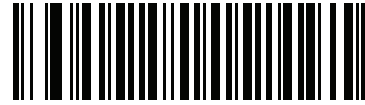
**\*Use All Channels (Standard AFH)**



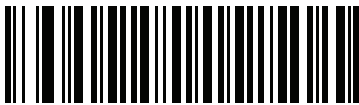
**Exclude Wi-Fi Channel 1**



**Exclude Wi-Fi Channel 6**



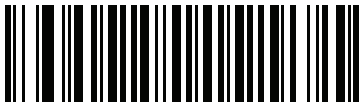
**Exclude Wi-Fi Channel 11**



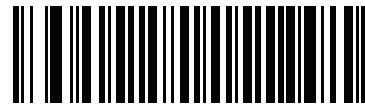
**Exclude Wi-Fi Channels 1, 6, and 11**



**Exclude Wi-Fi Channels 1 and 6**



**Exclude Wi-Fi Channels 1 and 11**



**Exclude Wi-Fi Channels 6 and 11**

## Radio Output Power

### Parameter # 1324

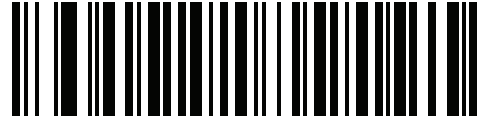
RS5100 uses a configurable radio which can be configured to operate in:

- Low power mode as a Class 2 device
- High power mode as Class 1 device.

Increase the radio output power to increase range. Scan a barcode to select the desired power mode.



**\*Class 2 (Low Power)**



**Class 1 (High Power)**

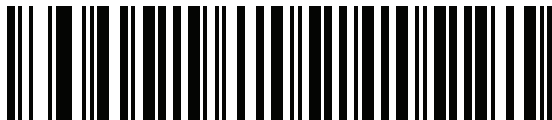
## Link Supervision Timeout

### Parameter # 1698

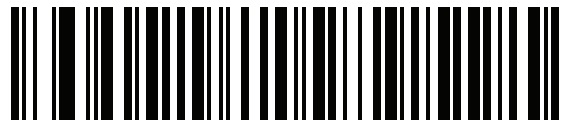
Link supervision timeout controls how quickly the RS5100 senses that the Bluetooth radio lost connection to the remote device. A lower value helps prevent data loss at the edge of the operating range while a larger value helps prevent disconnects due to the remote device not responding in time. If you are experiencing occasional disconnects and the RS5100 is able to reconnect, increase the link supervision timeout value.



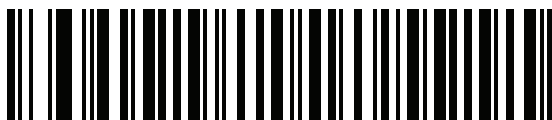
**NOTE:** The RS5100 only controls Link Supervision Timeout in Central mode.



**0.5 Seconds**

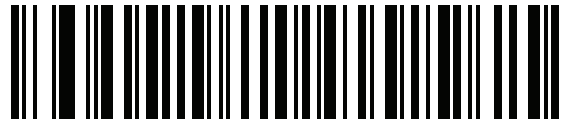


**\*2 Seconds**

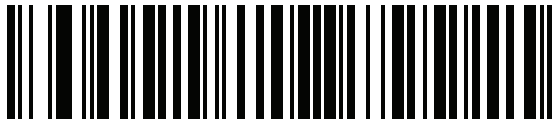


**5 Seconds**





10 Seconds



20 Seconds

## Reconnecting

When in SPP Central, SSI Bluetooth Classic, and Bluetooth HID, the RS5100 automatically tries to reconnect to a remote device when a disconnection occurs that is due to the radio losing communication. This can happen if the RS5100 goes out of range with the remote device, or if the remote device powers down. The RS5100 initiates auto-reconnect based on the Auto-Reconnect setting. The duration of the auto-reconnect attempt is specified by the Reconnect Attempt Interval setting. During reconnection, the Status LED blinks blue.

If the auto-reconnect process fails due to:

- Page Time-Outs - The RS5100 sounds a page timeout beep (long low/long high) and enters low power mode.
- Connection Attempt Rejected - The RS5100 sounds a connection reject beep sequence (see [Status Indications on page 17](#)) and enters low power mode.



**NOTE:** If a barcode is scanned while the auto-reconnect sequence is in process, a transmission error beep sequence sounds and the data is not transmitted to the host. After a connection is reestablished, normal scanning operation returns.

Switching between Bluetooth host types by scanning a host type barcode causes the radio to be reset. Scanning is disabled during this time. It takes several seconds for the RS5100 to re-initialize the radio at which time scanning is enabled.

## Restore Lost Bluetooth Connection

If the auto-reconnect process fails and times out, the Bluetooth connection is re-established as follows:

1. Ensure that the RS5100 is within a range of 10 meters (30 feet) from the mobile computer.
2. Ensure that the mobile computer is on and “awake” (not in Suspend mode).
3. Briefly press the Restore Key on the RS5100 to initiate the reconnect process.
4. The Status LED starts flashing blue indicating that the RS5100 is attempting to establish connection with a mobile computer. The Status LED turns off and the RS5100 emits one string of low/high beeps indicating that the RS5100 is connected and ready for scanning.

## Reconnect Attempt Beep Feedback

### Parameter # 559

When the RS5100 disconnects as it goes out of range, it immediately attempts to reconnect. While the RS5100 attempts to reconnect, the Status LED continues to blink blue. If the auto-reconnect process fails, the RS5100 emits a page timeout beep (long low/long high) and the Status LED stops blinking. The process can be restarted by pulling the trigger or pressing the restore key.

The Beep on Reconnect Attempt feature is disabled by default. When enabled, the RS5100 emits five short high beeps every five seconds while the re-connection attempt is in progress. Scan a barcode below to enable or disable Beep on Reconnect Attempt.



**\*Disable Beep on Reconnect Attempt  
(0)**



**Enable Beep on Reconnect Attempt  
(1)**

## Reconnect Attempt Interval

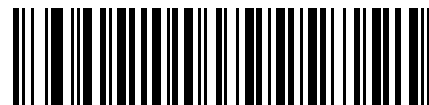
### Parameter # 558

When a RS5100 disconnects as it goes out of range, it immediately attempts to reconnect for the default time interval of 30 seconds. This time interval can be changed to one of the options below.

To set the Reconnect Attempt Interval, scan one of the barcodes below.



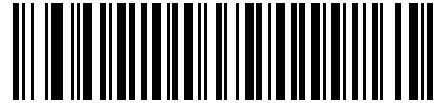
**\*Attempt to Reconnect for 30 Seconds  
(6)**



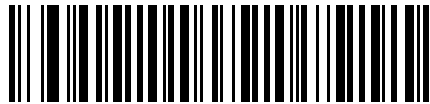
**Attempt to Reconnect for 1 Minute  
(12)**



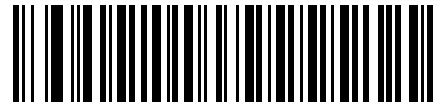
**Attempt to Reconnect for 5 Minutes  
(60)**



**Attempt to Reconnect for 30 Minutes  
(360)**



**Attempt to Reconnect for 1 Hour  
(720)**



**Attempt to Reconnect Indefinitely  
(0)**

## Auto-reconnect

### Parameter # 604

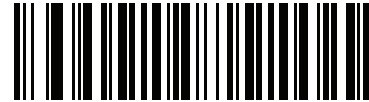
In Bluetooth Keyboard Emulation (HID) mode, SPP Central, and SSI Bluetooth Classic, select a re-connect option for when the RS5100 loses its connection with a remote device:

- **Auto-reconnect on Barcode Data:** The RS5100 auto-reconnects when you scan a barcode. With this option, a delay can occur when transmitting the first characters. The RS5100 sounds a decode beep upon barcode scan, followed by a connection, a page timeout, a rejection beep, or a transmission error beep. Select this option to optimize battery life on the RS5100 and mobile device. Note that auto-reconnect does not occur on rejection commands.
- **Auto-reconnect Immediately:** When the RS5100 loses connection, it attempts to reconnect. If a page timeout occurs, the RS5100 attempts reconnect by pulling the trigger or pressing the restore key. Select this option if the RS5100 battery life is not an issue and you do not want a delay to occur when the first barcode is transmitted. Note that auto-reconnect does not occur on rejection commands.

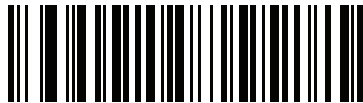
- **Disable Auto-reconnect:** When the RS5100 loses connection, you must re-establish it manually.



**Auto-reconnect on Barcode Data  
(1)**



**\*Auto-reconnect Immediately  
(2)**



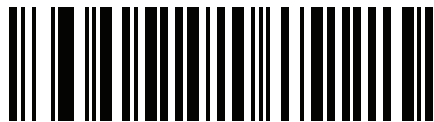
**Disable Auto-reconnect  
(0)**

## Pairing Support

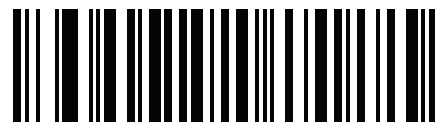
### Toggle Pairing

Parameter # 1322

If the RS5100 is configured for Toggle Pairing, scanning a pairing barcode a second time will unpair the scanner.



**\*Toggle Pairing Disable**



**Toggle Pairing Enable**

## Force Pairing Save

The Force Pairing Save parameter enables/disables saving the remote Bluetooth address after each Bluetooth connection attempt.

When this parameter is disabled, the Bluetooth address is saved only after a successful Bluetooth connection. If the Bluetooth connection fails, the Bluetooth address is not saved.



**NOTE:** This parameter is effective when the RS5100 connects as Central.



**Disable**



**\*Enable**

## Auto Un-Pairing

### Parameter # 1708

The auto un-pair parameter configures the RS5100 to un-pair from the host computer on specific events.

- **Disable (default)** - the RS5100 will not auto un-pair on any events.
- **On cradle insertion** - the RS5100 will un-pair when inserted charging cradle
- **On reset** - the RS5100 will un-pair if a warm or cold reset occurs
- **On cradle or reset** - the RS5100 will un-pair on cradle insertion or reset event.



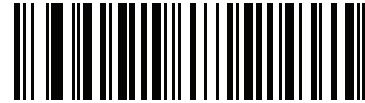
**\*Disable**



**Un-pair on Cradle Insertion**



On Reset



On Cradle or Reset

### Pairing Barcode Format

When pairing the RS5100 to certain host devices in SSI Bluetooth Classic, SPP Bluetooth Central or Bluetooth HID, it is necessary to create a pairing barcode. The RS5100 scans the pairing barcode and initiates the connection to the host computer. To create a pairing barcode label, the Bluetooth address of the remote device must be known (refer to the mobile computer user guide).

Pairing barcodes are Code 128 or Data Matrix symbologies formatted as follows:

<Fnc 3>Bxxxxxxxxxxxx

where:

- **B** (or **LNKB**) is the prefix
- xxxxxxxxxxxx represents the 12-character Bluetooth address.

### Pairing Barcode Example

If the mobile computer Bluetooth address is 11:22:33:44:55:66, then the pairing barcode is:



Figure 33 Creating a Pairing Bluetooth Barcode

### Unpairing

Unpair the RS5100 from the host computer to make the host computer available for pairing with another RS5100. Scan the barcode below to disconnect the RS5100 from its host computer.



Unpairing

## Batch Mode

### Parameter # 544



**IMPORTANT:** Batch mode only applies for HID and SPP Central Mode.

The RS5100 supports five versions of batch mode. When the RS5100 is configured for any of the batch modes, it attempts to store barcode data (not parameter barcodes) until transmission is initialized, or the maximum number of barcodes are stored. When a barcode is saved successfully, a good decode beep sounds and the LED flashes green. If the RS5100 is unable to store a new barcode, a low/high/low/high out of memory beep sounds. (See page 17 for all beeper and LED definitions.)

In all modes, calculate the amount of data (number of barcodes) the RS5100 can store as follows:

$$\text{Number of storable barcodes} = 9,000 \text{ bytes of memory} / (\text{number of characters in the barcode} + 3).$$



**NOTE:** If the batch mode selection is changed while there is batched data, the new batch mode takes effect only after all the previously batched data is sent.

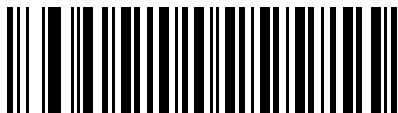
### Modes of Operation

- **Normal (default)** - Do not batch data. The RS5100 attempts to transmit every scanned barcode.
- **Out of Range Batch Mode** - The RS5100 starts storing barcode data when it loses its connection to a remote device (for example, when a user holding the RS5100 walks out of range). Data transmission is triggered by re-establishing the connection with the remote device (for example, when a user holding the RS5100 walks back into range).
- **Standard Batch Mode** - The RS5100 starts storing barcode data after **Enter Batch Mode** is scanned. Data transmission is triggered by scanning **Send Batch Data**.

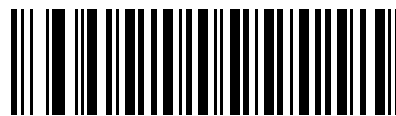


**NOTE:** Transmission is halted if the connection to the remote device is lost.

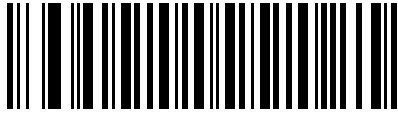
In all modes, transmissions are halted if the RS5100 is moved out of range. The RS5100 resumes when it is back in range. If a barcode is scanned while batch data is transmitted it is appended to the end of the batched data; parameter barcodes are not stored.



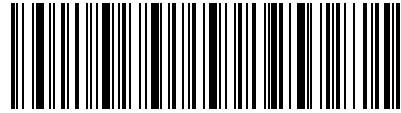
\*Normal  
(00h)



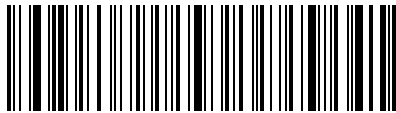
Out of Range Batch Mode  
(01h)



**Standard Batch Mode  
(02h)**



**Enter Batch Mode**



**Send Batch Data**



## Unique Identifier (SPP only)

When using Batch Mode, enable Unique Identifier to add the device serial number to each payload data sent in Batch Mode.



**\*Disable**



**Enable**

## Image Capture (SPP only)

Image Capture mode allows the RS5100 to capture an image and send the binary data over the SPP connection. The connected device uses the binary data, starting from the JPG signature (hex value FF D8 FF), to create the image file in JPG format.

To use Image Capture mode:

1. Change the RS5100 to SPP mode. See [Serial Port Profile on page 51](#).
2. Pair and connect the RS5100 to a device.
3. Enable Image Capture mode by sending the character **i** to the RS5100. See [Special characters on page 58](#).  
The cross hair laser beam illuminates, indicating that the RS5100 is ready to capture an image.
4. Press the Scan trigger.

After capturing an image the RS5100 performs the following in order:

- Sends the data to the connected device
- Exits Image Capture mode

Returns to the previous barcode scanning mode.

# Accessories

## Accessories

**Table 4** Accessories

Accessory	Part Number	Description
<b>Cradles</b>		
4-Slot RS5100 Charge Only Cradle	CRD-RS51-4SCHG-01	Charges up to four devices with batteries. Requires Power Supply PWR-BGA12V50W0WW, DC Line Cord CBL-DC-388A1-01 and Country Specific 3 wire AC Line Cord.
20-Slot RS5100 Charge Only Cradle	CRD-RS51-20SCHG-01	Charges up to twenty devices with batteries. Requires Power Supply PWR-BGA12V50W0WW, DC Line Cord CBL-DC-388A1-01 and Country Specific 3 wire AC Line Cord.
WT6000 / RS5100 5 Slot Charge Only Sharecradle	CRD-4WT6-4RS51-01	WT6000 / RS5100 5 Slot Charge Only Sharecradle, Allows Charging of 4 WT6000 Terminals, 4 WT6000 Spare Batteries and 4 RS5100 Ring Scanners.
TC5x / RS5100 5 Slot Charge Only Sharecradle	CRD-4TC5-4RS51-01	TC5x / RS5100 5 Slot Charge Only Sharecradle, Allows Charging of 4 TC5x Terminals and 4 RS5100 Ring Scanners.
<b>Batteries and Chargers</b>		
Replacement Standard Battery	BTRY-RS51-4MA-01	Replacement standard battery for RS5100 (single pack).
Replacement Standard Battery	BTRY-RS51-4MA-10	Replacement standard battery for RS5100 (ten pack).
Replacement Standard Battery	BTRY-RS51-4MA-CN	Replacement standard battery for RS5100, China only.
Replacement Standard Battery	BTRY-RS51-4MA-02	Replacement standard battery for RS5100, India and South Korea only.
Replacement Extended Battery	BTRY-RS51-7MA-01	Replacement extended battery for RS5100 (single pack).

## Accessories

**Table 4** Accessories (Continued)

Accessory	Part Number	Description
Replacement Extended Battery	BTRY-RS51-7MA-10	Replacement extended battery for RS5100 (ten pack).
Replacement Extended Battery	BTRY-RS51-7MA-02	Replacement extended battery for RS5100, India and South Korea only.
8-Slot Battery Charger	SAC-RS51-8SCHG-01	Charges up to eight spare batteries. Requires Power Supply PWR-BGA12V50W0WW, DC Line Cord CBL-DC-388A1-01 and Country Specific 3 wire AC Line Cord.
40-Slot Battery Charger	SAC-RS51-40SCHG-01	Charges up to forty spare batteries. Requires Power Supply PWR-BGA12V50W0WW, DC Line Cord CBL-DC-388A1-01 and Country Specific 3 wire AC Line Cord.
<b>Triggers and Soft Goods</b>		
Replacement Trigger Assembly	SG-RS51-TRGSS-01	RS5100 replacement Single Sided Trigger. Includes comfort pad and nylon strap.
Replacement Finger Strap	SG-RS51-STRPNY-10	RS5100 replacement Spare nylon finger straps for single sided trigger (10-pack).
Replacement Comfort Pad	SG-RS51-CMPD-05	RS5100 replacement comfort pads, to be used with single sided trigger (5-pack).
Replacement Trigger Assembly - Double Trigger: Standard Charge Contacts	SG-RS51-TRGDS-01	RS5100 replacement Double Sided Trigger. Replacement straps for double trigger (SG-RS51-STRPDT-10).
Replacement Trigger Assembly - Double Trigger: Standard Charge Contacts and Vibrator option	SG-RS51-TRGDV-01	RS5100 replacement Double Sided Trigger with vibrator. Replacement straps for double trigger (SG-RS51-STRPDT-10).
Replacement Trigger Assembly - Double Trigger: USB-C Charge Port	SG-RS51-TRGDU-01	RS5100 replacement Double Sided Trigger with USB-C. USB-C port on assembly allows the RS5100 to be charged via a USB cable and also allows for programming using 123Scan. Replacement straps for double trigger (SG-RS51-STRPDT-10).
Back of Hand Adapter	SG-RS51-BHMT-01	Back of Hand Mount, includes hand strap. Allows the RS5100 to be worn on the back of hand and provides a remote finger trigger. One size fits all; ambidextrous.
Replacement Hand Strap	SG-RS51-BHSTP-01	Replacement strap for RS5100 back of hand mount.
Hand Mount - Left/Large	SG-RS51-HNMTLL-01	Hand Mount for RS5100, Left Hand Large, Includes Frame, Trigger and Hand Wrap.

## Accessories

**Table 4** Accessories (Continued)

Accessory	Part Number	Description
Hand Mount - Left/Medium	SG-RS51-HNMTLM-01	Hand Mount for RS5100, Left Hand Medium, Includes Frame, Trigger and Hand Wrap.
Hand Mount - Left/Small	SG-RS51-HNMTLS-01	Hand Mount for RS5100, Left Hand Small, Includes Frame, Trigger and Hand Wrap.
Hand Mount - Right/Large	SG-RS51-HNMTRL-01	Hand Mount for RS5100, Right Hand Large, Includes Frame, Trigger and Hand Wrap.
Hand Mount - Right/Medium	SG-RS51-HNMTRM-01	Hand Mount for RS5100, Right Hand Medium, Includes Frame, Trigger and Hand Wrap.
Hand Mount - Right/Small	SG-RS51-HNMTRS-01	Hand Mount for RS5100, Right Hand Small, Includes Frame, Trigger and Hand Wrap.
Replacement Hand Wrap - Left/Large	SG-RS51-HNWPLL-01	Spare Hand Wrap for RS5100, Left Hand Large.
Replacement Hand Wrap - Left/Medium	SG-RS51-HNWPLM-01	Spare Hand Wrap for RS5100, Left Hand Medium.
Replacement Hand Wrap - Left/Small	SG-RS51-HNWPLS-01	Spare Hand Wrap for RS5100, Left Hand Small.
Replacement Hand Wrap - Right/Large	SG-RS51-HNWPRL-01	Spare Hand Wrap for RS5100, Right Hand Large.
Replacement Hand Wrap - Right/Medium	SG-RS51-HNWPRM-01	Spare Hand Wrap for RS5100, Right Hand Medium.
Replacement Hand Wrap - Right/Small	SG-RS51-HNWPRS-01	Spare Hand Wrap for RS5100, Right Hand Small.
Lanyard Trigger Assembly	SG-RS51-LNYD-01	Allows the RS5100 to be worn around the neck or hip. Requires separate purchase of the retractor with magnetic recoil (SG-RS51-RLYD1-01) for neck or hip mounting.
Retractor with Magnetic Recoil for Lanyard Trigger Assembly	SG-RS51-RLYD1-01	Allows RS5100 units with Lanyard Trigger Assembly (SG-RS51-LNYD-01) to be worn around the neck or hip. For use with RS51B0-LBLNWR, RS51B0-TBLNWR or SG-RS51-LNYD-01.

## Charging

Use one of the accessories in the following table to charge the RS5100 and/or spare battery.

**Table 5** Charging and Communication

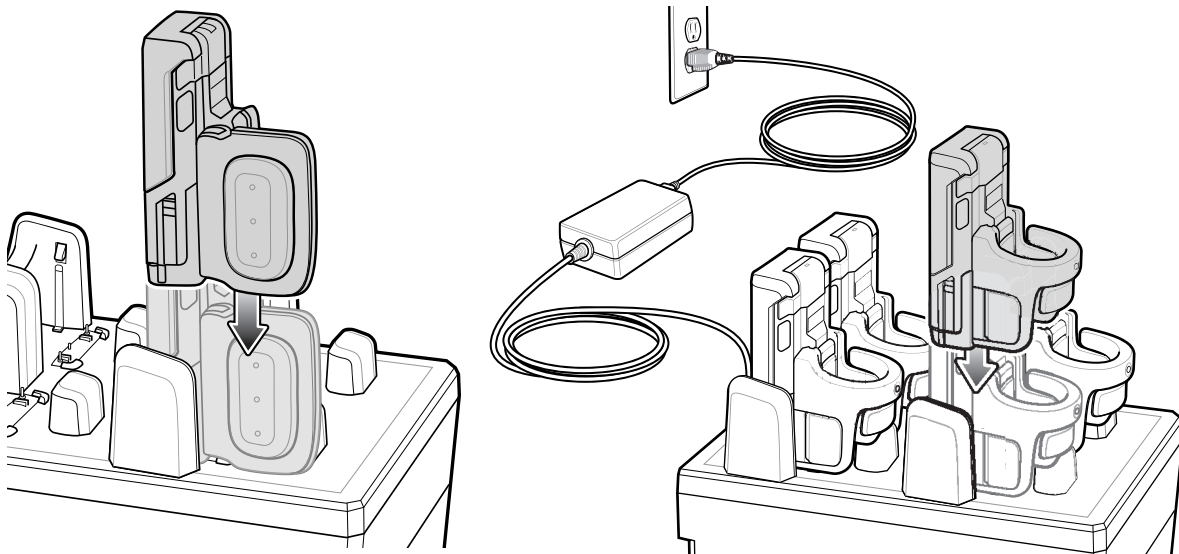
Description	Part Number	Charging		Communication	
		Battery (In Device)	Battery Only	microUSB to USB	Ethernet
4-Slot RS5100 Charge Only Cradle	CRD-RS51-4SCHG-01	Yes	No	No	No
20-Slot RS5100 Charge Only Cradle	CRD-RS51-20SCHG-01	Yes	No	No	No
8-Slot Battery Charger	SAC-RS51-8SCHG-01	No	Yes	No	No
40-Slot Battery Charger	SAC-RS51-40SCHG-01	No	Yes	No	No

## Charging the RS5100

To Charge the RS5100:

1. Insert the RS5100 into the RS5100 charging slot with the scan window facing the charge contacts.

**Figure 34** Insert RS5100 Single Trigger and Double Trigger into Cradle



2. Ensure that the RS5100 is properly seated in the charging slot.

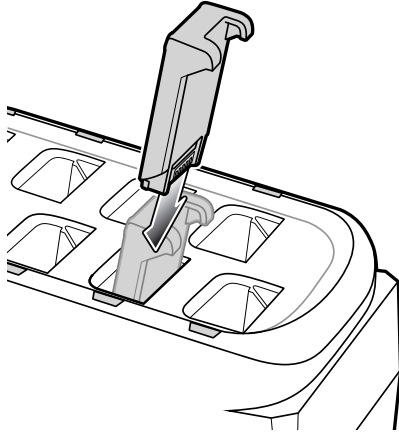


**NOTE:** It is suggested to charge the RS5100 before doing a firmware update over Bluetooth.

## Charging the Spare Battery

1. Insert a spare battery into the spare battery slot.

**Figure 35** Insert Battery into Cradle



2. Ensure the battery is seated properly. The Spare Battery Charging LED blinks indicating charging.

## Battery Charging

The RS5100 Charging LED indicates the charging status of the battery in the RS5100 and the Spare Battery Charging LED indicates the charging status of the spare battery. See [Table 6 on page 86](#).



**NOTE:** Brand new batteries from the factory are shipped in Ship Mode for protection, and need to be plugged into a charger (cradle or battery toaster) to activate the battery.

**Table 6** Charging LED Indicators

State	Indication
Off	The battery is not charging. The RS5100 or battery is not inserted correctly in the cradle or connected to a power source. Cradle is not powered.
Solid Amber	Battery is charging.
Solid Green	Battery charging is complete.
Fast Blinking Red (2 blinks/second)	Charging error, e.g.: - Battery temperature is too low or too high for charging. - The battery has reached the charge cycle time-out period. Battery charging has gone on too long without completing a full charge cycle (typically eight hours).
Solid Red	Unhealthy battery is charging or fully charged.

Charge batteries in temperatures from 5°C to 40°C (41°F to 105°F). The standard battery charges from 0% to 90% in less than two and a half hours at room temperature. The extended battery charges from 0% to 90% in less than three and a half hours at room temperature. When the charging temperature is from 5°C to 10°C (41°F to 50°F), the standard battery charges in less than five hours. When the charging temperature is between 5°C and 10°C (41°F to 50°F), the extended battery charges in less than six hours.

The device and cradle monitor the battery temperature. Battery charging is only performed when the battery is within safe charging temperature limits. At higher temperatures (e.g. approximately +35 °C (+95 °F)) the device or charging cradle may for small periods of time alternately enable and disable battery charging to keep the battery at acceptable temperatures. This process may require additional time to complete a full charge cycle. The RS5100 or cradle indicate when charging is disabled due to abnormal temperatures via the Status LED.



## 4-Slot RS5100 Charge Only Cradle

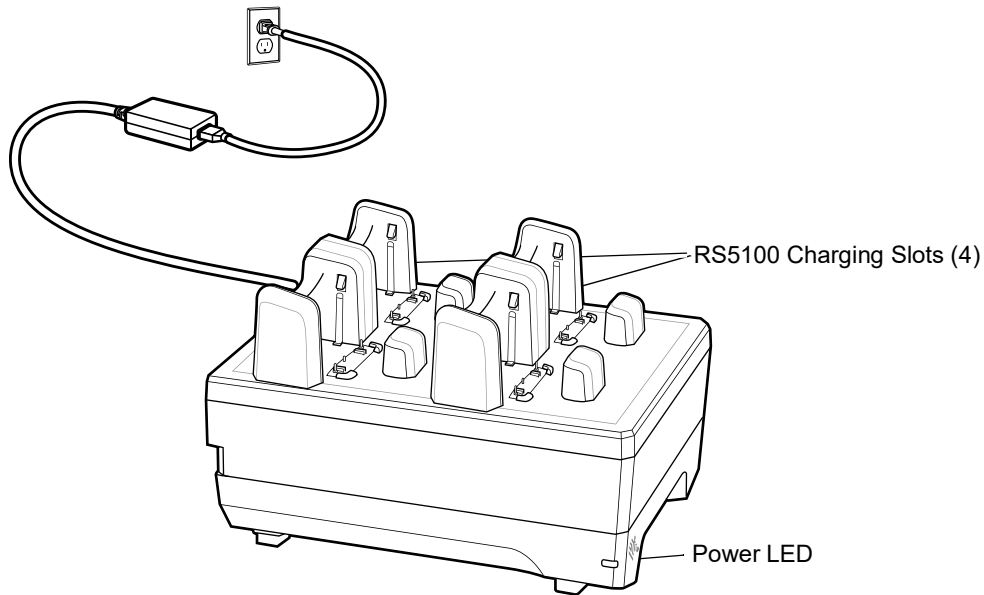


**NOTE:** Ensure that you follow the guidelines for battery safety described in [Battery Safety Guidelines on page 293](#).

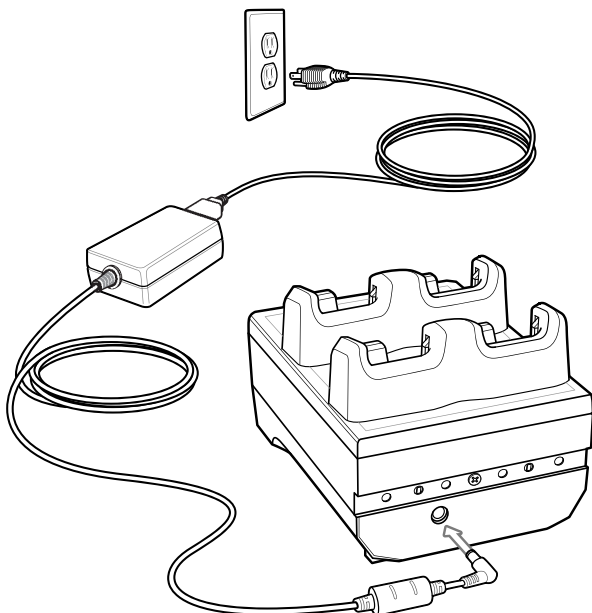
The 4-Slot RS5100 Charge Only Cradle:

- provides power for operating the RS5100.
- charges up to four batteries in the RS5100.

**Figure 36** 4-Slot RS5100 Charge Only Cradle



**Figure 37** 4-Slot RS5100 Charge Only Cradle Setup



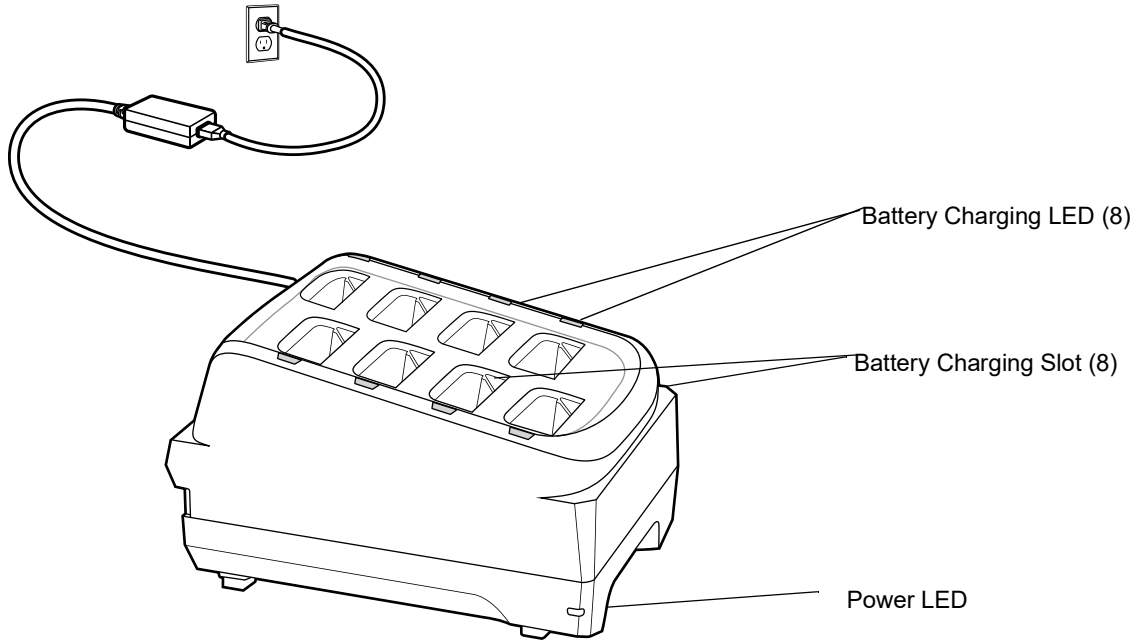
## 8-Slot Battery Charger



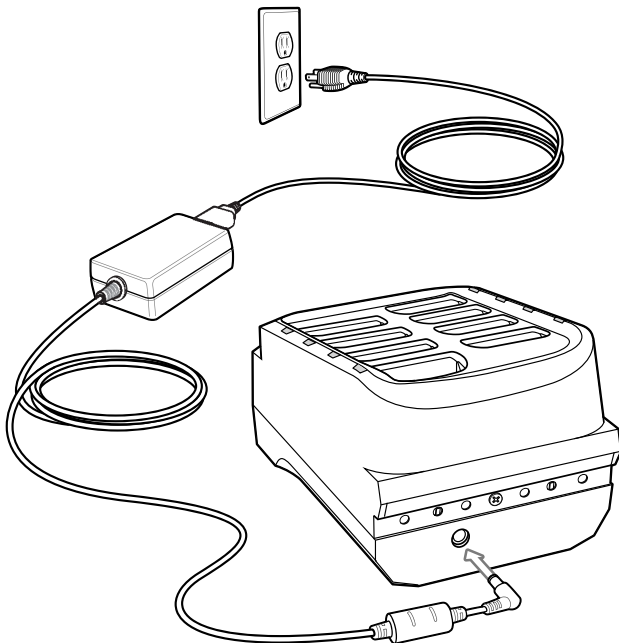
**NOTE:** Ensure that you follow the guidelines for battery safety described in [Battery Safety Guidelines on page 293](#).

The 8-Slot Battery Charger charges up to eight spare batteries.

**Figure 38** 8-Slot Battery Charger



**Figure 39** 8-Slot Battery Charger Setup



## 20-Slot RS5100 Charge Only Cradle



**NOTE:** Ensure that you follow the guidelines for battery safety described in [Battery Safety Guidelines on page 293](#).

The 20-Slot RS5100 Charge Only Cradle:

- provides power for operating the RS5100.
- charges up to twenty batteries in the RS5100.

**Figure 40** 20-Slot RS5100 Charge Only Cradle

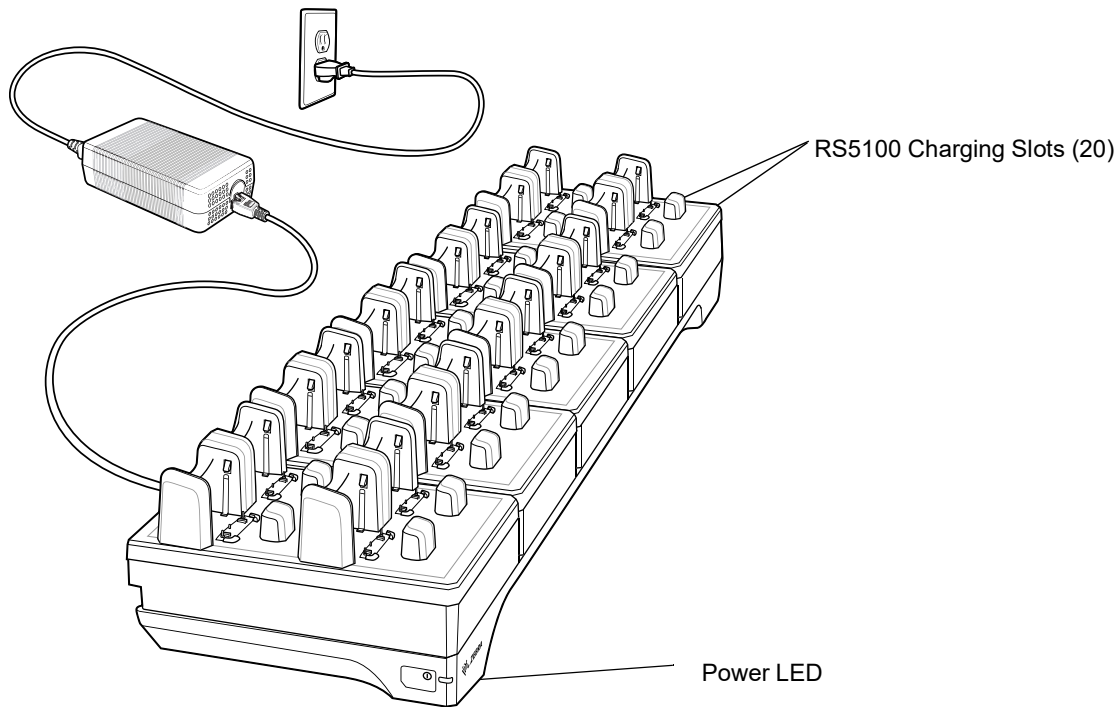
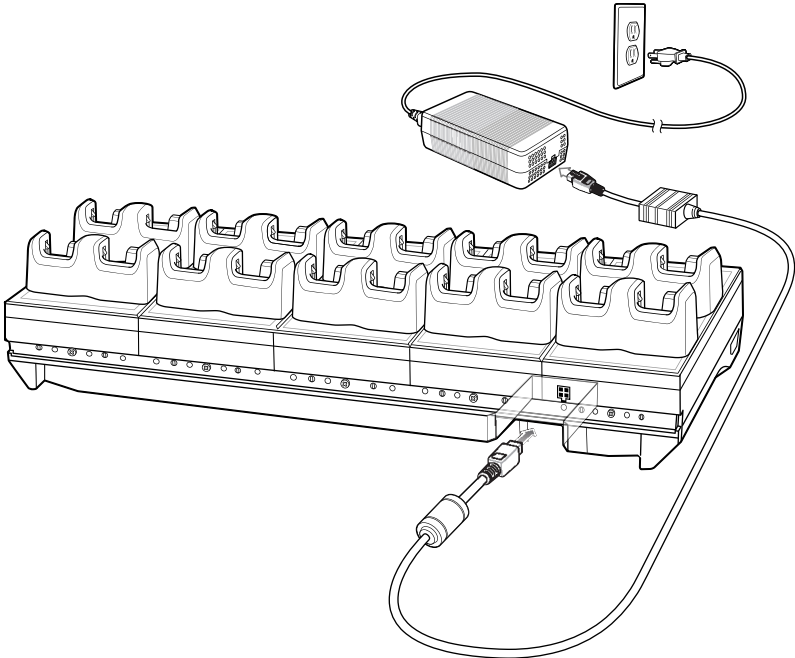


Figure 41 20-Slot RS5100 Charge Only Cradle Setup



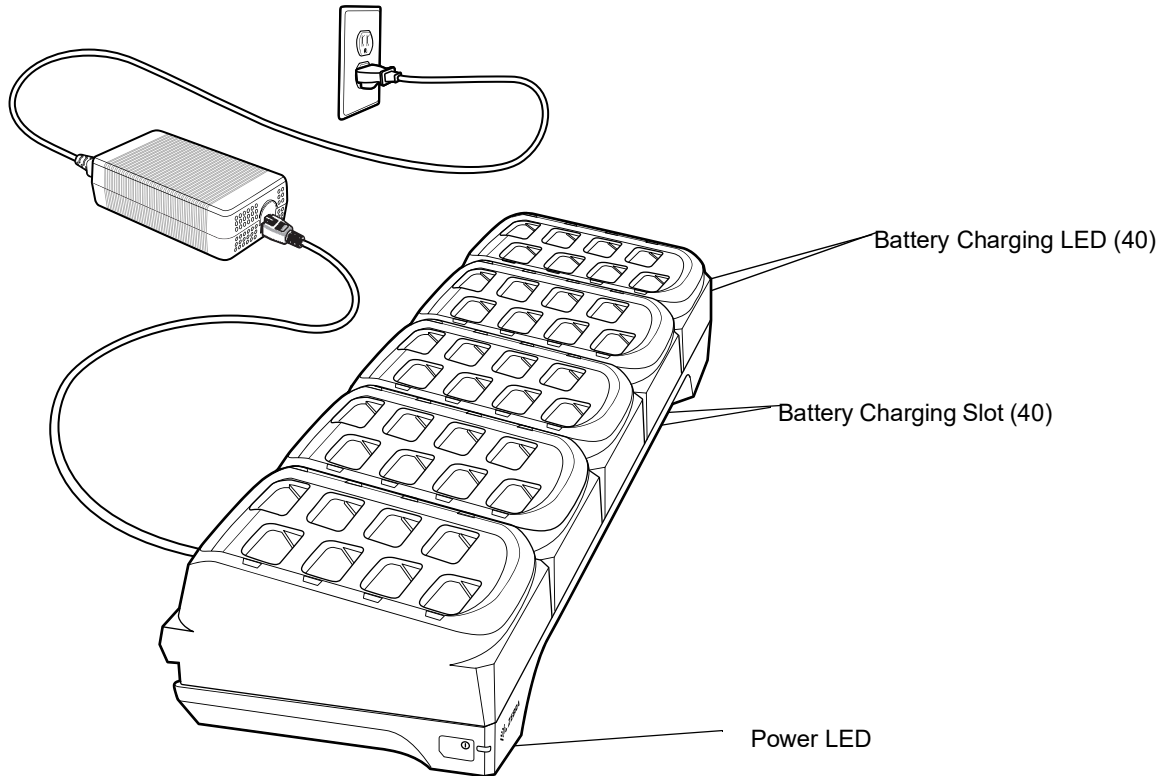
## 40-Slot Battery Charger



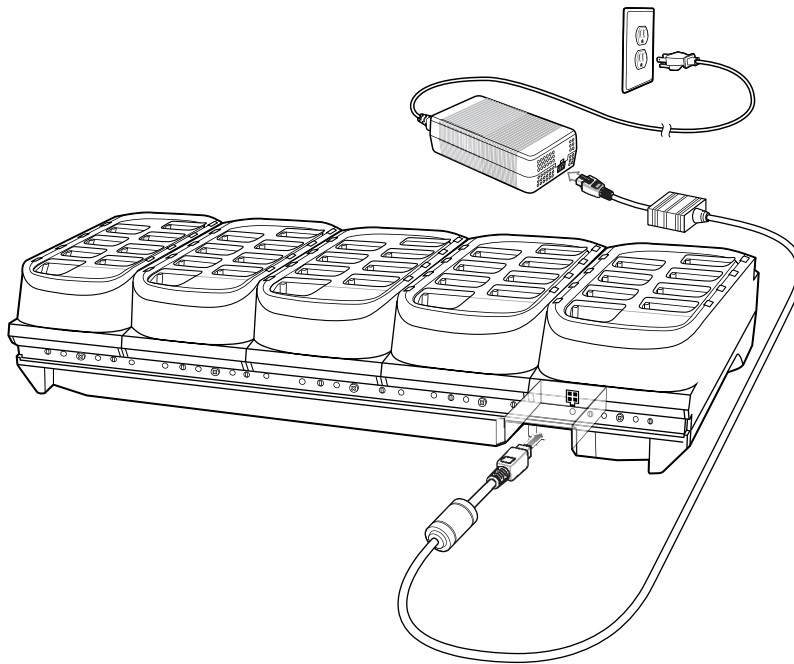
**NOTE:** Ensure that you follow the guidelines for battery safety described in [Battery Safety Guidelines on page 293](#).

The 40-Slot Battery Charger charges up to forty spare batteries.

**Figure 42** 40-Slot Battery Charger



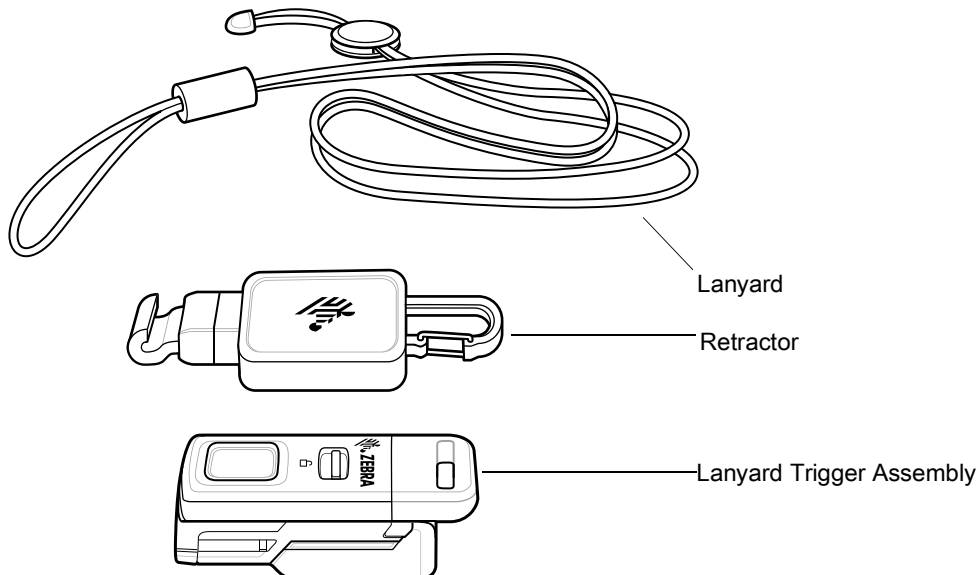
**Figure 43** 40-Slot Battery Charger Setup



## Lanyard Mount

The lanyard mount is comprised of the lanyard trigger assembly, retractor, and lanyard. The lanyard trigger assembly allows the RS5100 to be worn around the neck or hip. It requires separate purchase of the retractor with magnetic recoil for neck or hip mounting.

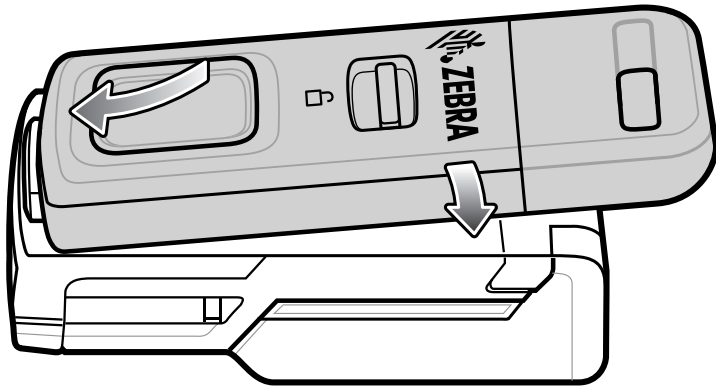
**Figure 44** Lanyard Mount



To attach the lanyard trigger assembly and retractor to the RS5100:

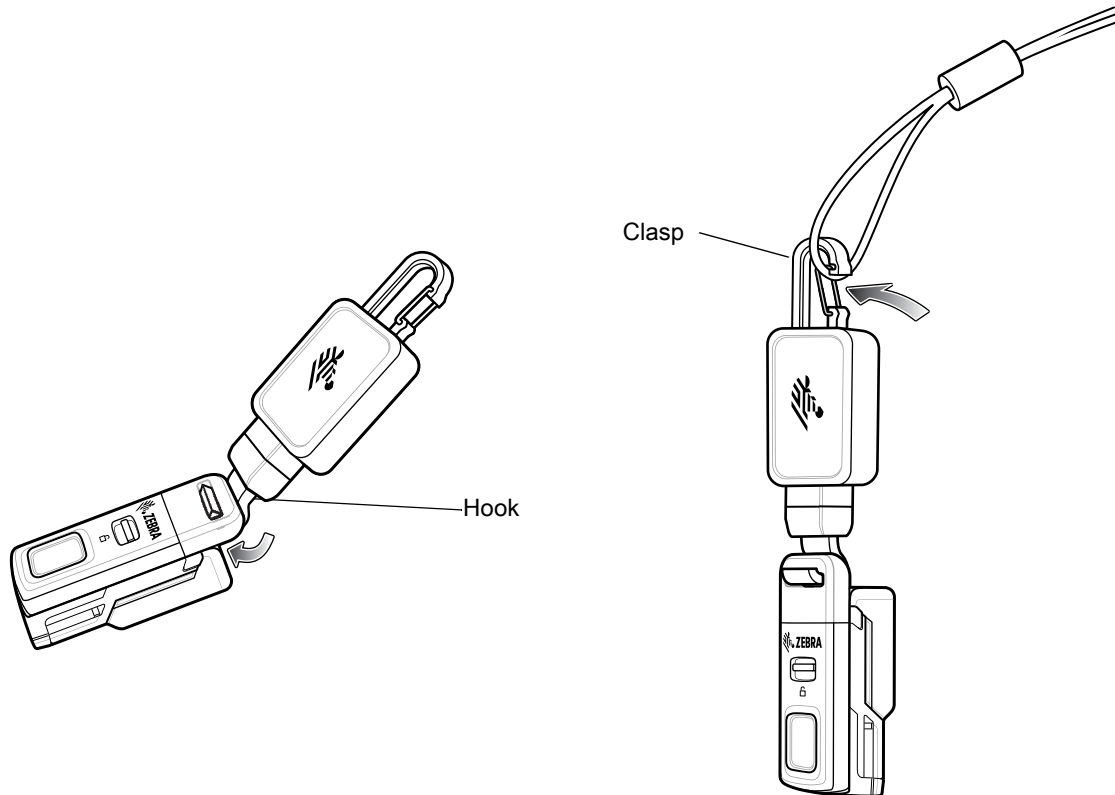
1. Align the contacts on the RS5100 assembly with the contacts on the back of the lanyard trigger assembly and slide the lanyard trigger assembly into the notch on the RS5100 assembly.

**Figure 45** Attach Lanyard Trigger Assembly



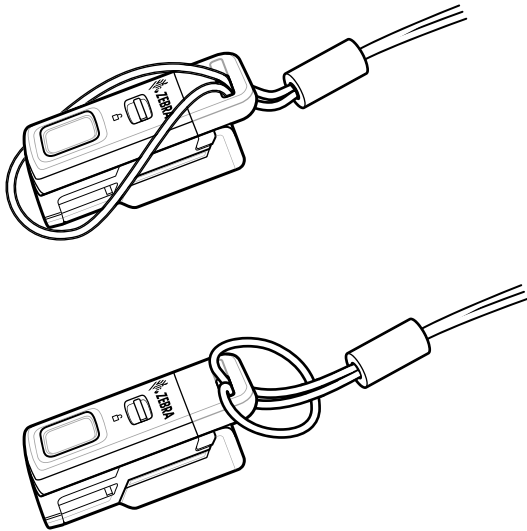
2. Push down on the lanyard trigger assembly to snap into place.
3. If using the retractor (optional), slide the hook on the bottom of the retractor into the top/front slot on the lanyard trigger assembly and push the lanyard through the clasp on the top of the retractor.

**Figure 46** Attach Lanyard With Retractor



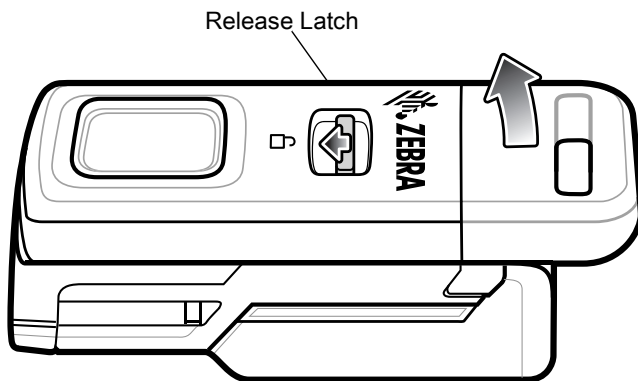
4. If you are not using the retractor, insert the lanyard through the top/front slot on the lanyard trigger assembly.

**Figure 47** Attach Lanyard Without Retractor



To remove the lanyard trigger assembly, slide the release latch and detach the lanyard trigger assembly from the RS5100 assembly.

**Figure 48** Detach Lanyard Trigger



## Back of Hand Mount

The Back of Hand Mount (which includes a hand strap), allows the RS5100 to be worn on the back of your hand and provides a remote finger trigger. It is one size to fit all and is ambidextrous.

To attach the back of hand mount, perform the following three steps:

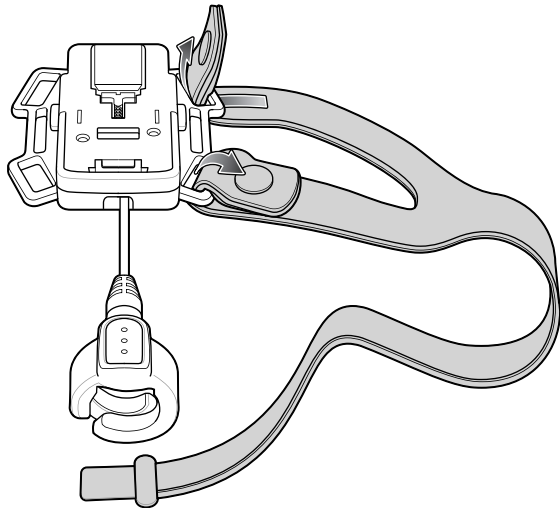
1. Install the strap to the back of hand assembly (there is a difference for a right hand user and a left hand user)
2. Position the back of hand mount on the hand
3. Install the RS5100 onto the back of hand mount.

To install the strap to the back of hand assembly for a right hand user:

1. Hold the Y shape strap in one hand and the back of hand assembly in the other hand.
2. Slide one end of the strap with the snap through the top left slot on the back of hand assembly and snap into place.

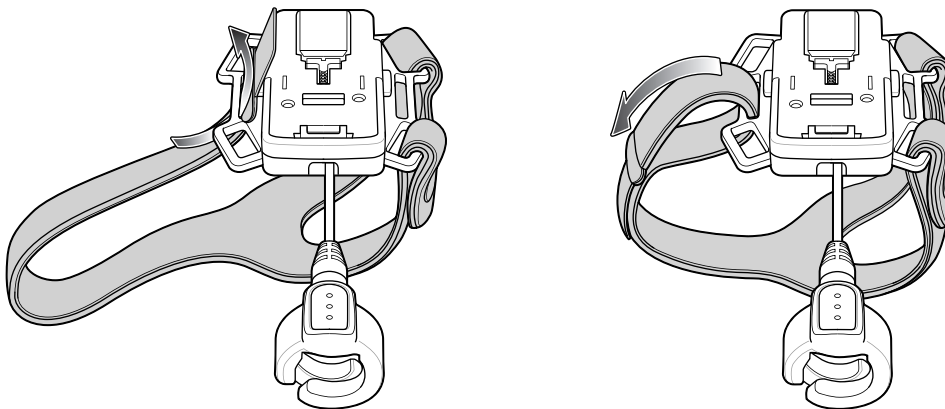


**Figure 49** Right Hand User: Snap Strap Into Place



3. Slide the other end of the strap with the snap through the bottom left slot on the back of hand assembly and snap into place.
4. Slide the remaining long end of the strap with the velcro through the right center slot of the back of hand assembly and velcro in place.

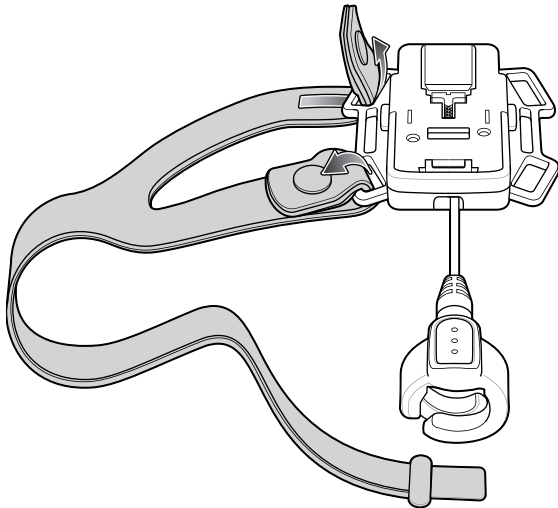
**Figure 50** Right Hand User: Velcro Strap Into Place



To install the strap to the back of hand assembly for a left hand user:

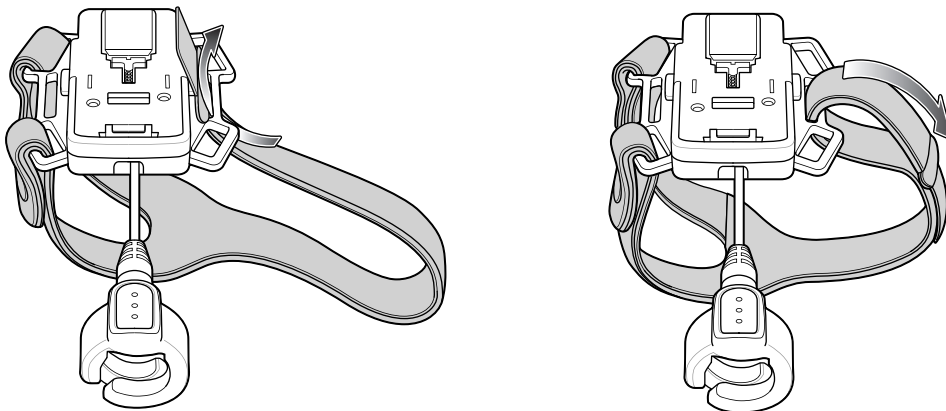
1. Hold the Y shape strap in one hand and the back of hand assembly in the other hand.
2. Slide one end of the strap with the snap through the top right slot on the back of hand assembly and snap into place.

**Figure 51** Left Hand User: Snap Strap Into Place



3. Slide the other end of the strap with the snap through the bottom right slot on the back of hand assembly and snap into place.
4. Slide the remaining long end of the strap with the velcro through the left center slot of the back of hand assembly and velcro in place.

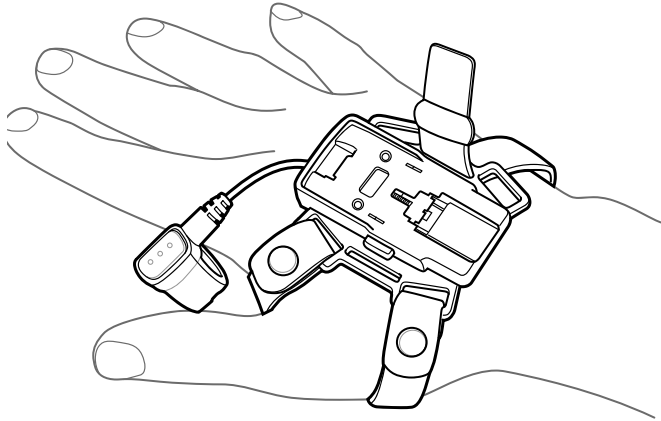
**Figure 52** Left Hand User: Velcro Strap Into Place



To position the back of hand mount on the hand:

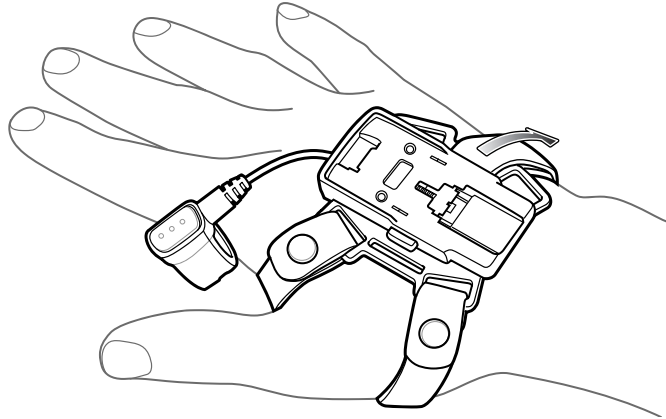
1. Slide your hand through the strap, with your thumb through the smaller opening between the two snaps and your remaining four fingers through the larger opening.

**Figure 53** Slide Hand Through Strap



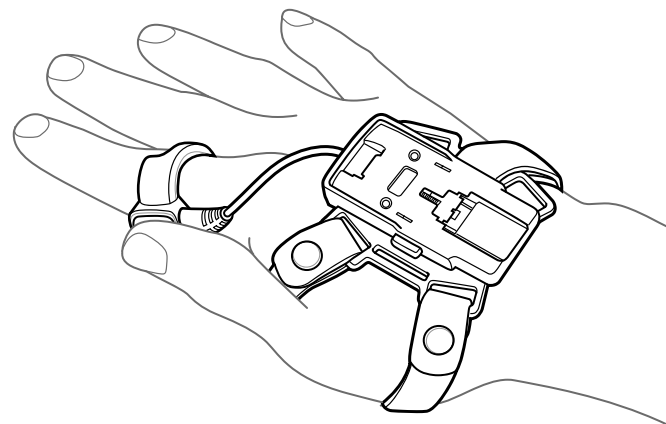
2. Adjust the velcro to a comfortable position.

**Figure 54** Adjust Velcro



3. Pull the finger trigger to place it over your index finger and slide the finger trigger down the index finger.
4. Rotate the finger trigger so that the trigger button is easy access to your thumb.

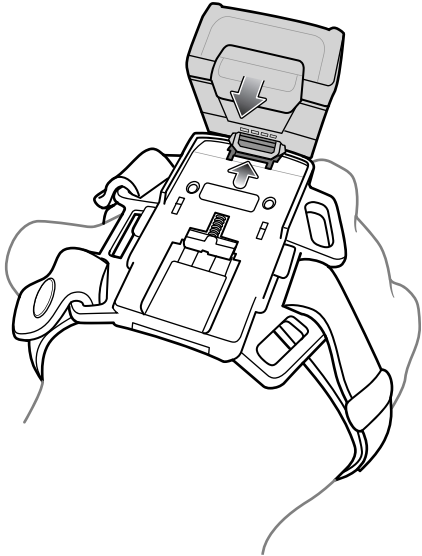
**Figure 55** Position Finger Trigger



To install the RS5100 onto the back of hand mount:

1. Align the contacts on the RS5100 assembly with the contacts on the back of hand mount and engage the slot (located at the top of the RS5100 on the backside) on the RS5100 with the opening at the top of the back of hand mount.

**Figure 56** Align and Engage RS5100

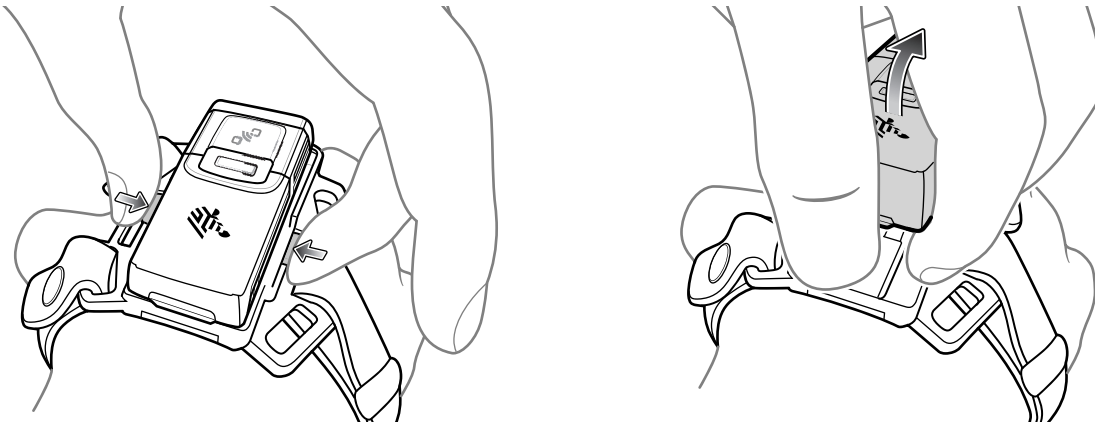


2. Push down on the RS5100 to snap into place.

**Figure 57** Push Down To Snap In Place



To detach the RS5100 from the back of hand mount, press the release buttons on both sides of the back of hand mount using your thumb and middle finger, and lift the RS5100 off the back of hand mount using your index finger.

**Figure 58** Detach RS5100 From Back of Hand Mount

## Hand Mount Glove

The Hand Mount Glove allows the RS5100 to be worn on the back of your hand and provides a remote finger trigger. It comes in multiple sizes to fit all and is available for right-handed and left-handed users. You can distinguish the size by the color of the stitching on the glove.

- Small = white
- Medium = black
- Large = blue

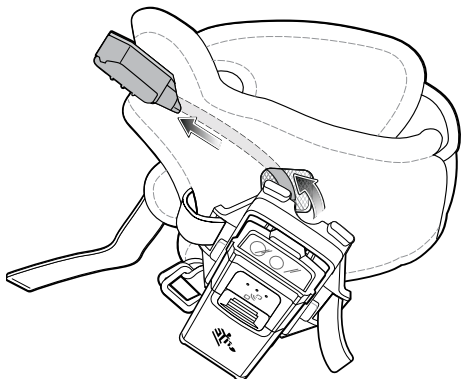
To attach the hand mount glove to the hand mount assembly, perform the following steps:

1. Install the glove to the back of hand assembly, if not already installed (note the position for right hand user or left hand user).
2. Position the hand mount glove on the hand.
3. Install the RS5100 onto the back of hand mount, if not already installed.

### Install Glove: Right Hand User

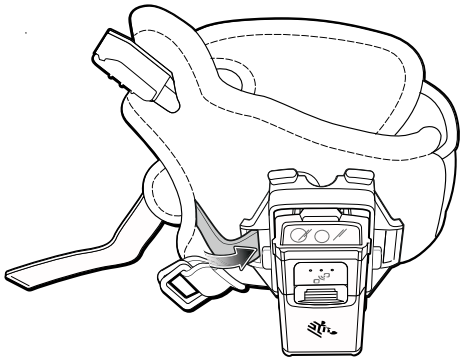
To install the glove to the back of hand assembly for a right hand user:

1. Insert the trigger cable and button through the trigger slot.

**Figure 59** Insert Trigger Cable and Button

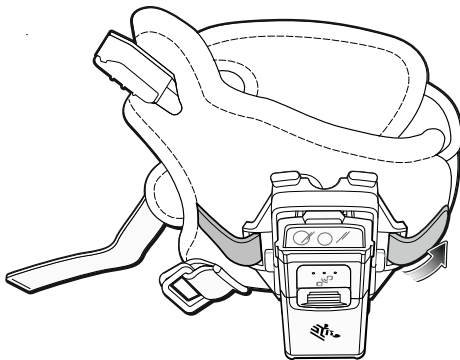
2. Insert the velcro strap through the left slot of the mount and slide under the mount.

**Figure 60** Insert Velcro Strap Through Slot



3. Insert the velcro strap through the right slot of the mount and fasten the velcro strap end.

**Figure 61** Insert Velcro Strap Through Other Slot and Fasten

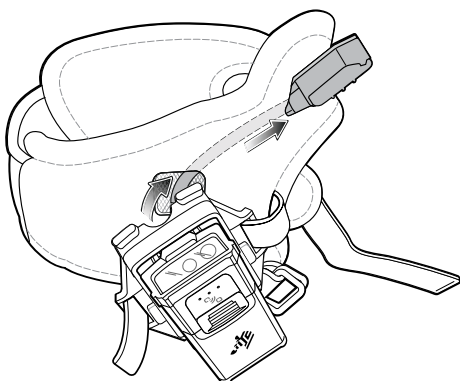


## Install Glove: Left Hand User

To install the glove to the back of hand assembly for a left hand user:

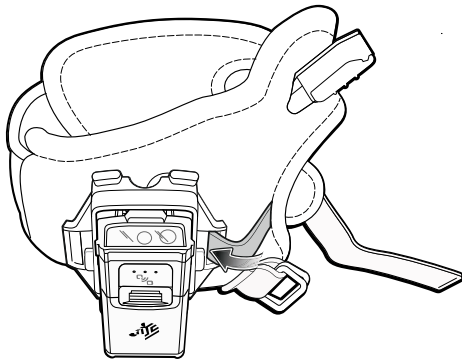
1. Insert the trigger cable and button through the trigger slot.

**Figure 62** Insert Trigger Cable and Button



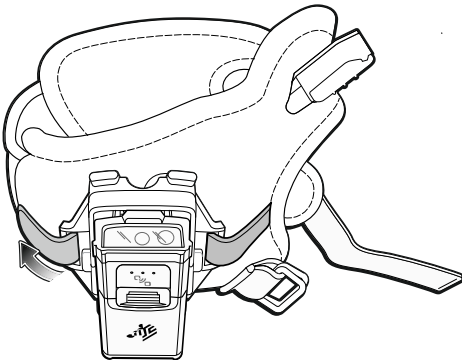
2. Insert the velcro strap through the right slot of the mount and slide under the mount.

**Figure 63** Insert Velcro Strap Through Slot



3. Insert the velcro strap through the left slot of the mount and fasten the velcro strap end.

**Figure 64** Insert Velcro Strap Through Other Slot and Fasten

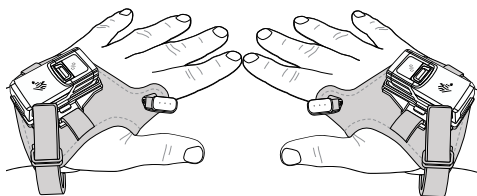


## Position Glove on Hand

To position the glove on the hand:

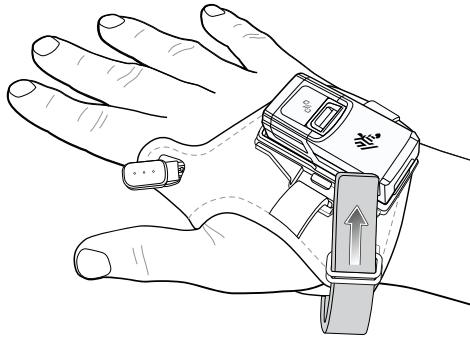
1. Slide your hand through the glove, with your thumb through the smaller opening and your remaining four fingers through the larger opening. Note the position for a left-hand user and a right-hand user.

**Figure 65** Slide Hand Through Glove



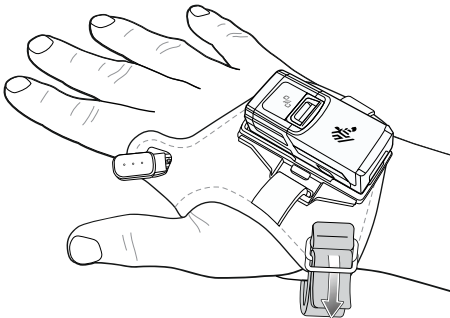
2. Adjust the strap to a comfortable position to fit securely by tightening or loosening the strap.

**Figure 66** Adjust the Strap



3. Slide the strap through the buckle and secure the end of the strap in place with the velcro.

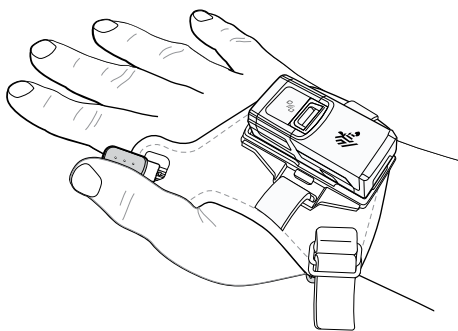
**Figure 67** Slide Strap Through Buckle and Secure Strap



**NOTE:** The snap under the strap is meant as a safety breakaway and is not meant for securing the strap.

4. Position the finger trigger button to rotate it so that the button is easy access to your thumb and then fasten it in place with the velcro.

**Figure 68** Position the Finger Trigger Button

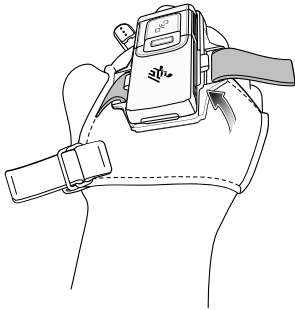


5. Align the mount on the glove. To do this:



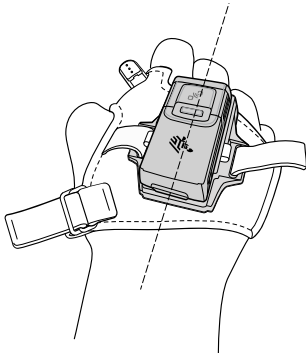
- a. Lift the velcro strap holding the mount in place.

**Figure 69** Lift the Velcro Strap



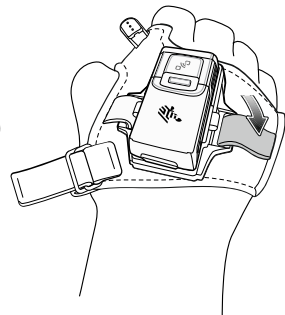
- b. Detach and lift the mount, which is holding the RS5100.
- c. Reposition the mount on the glove to align the mount with your middle finger knuckle.

**Figure 70** Reposition the Mount



- d. Fasten the velcro strap.

**Figure 71** Fasten the Velcro Strap

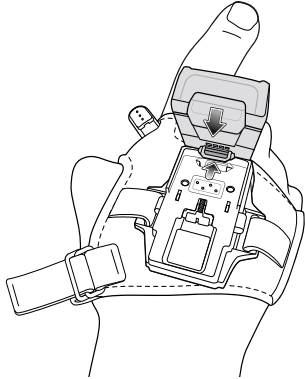


## Install RS5100

To install the RS5100 onto the back of hand mount:

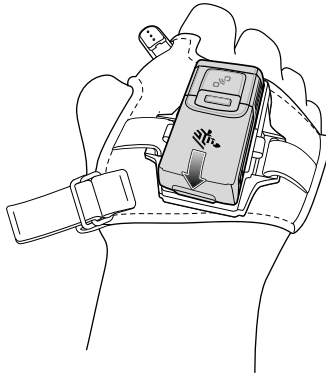
1. Align the contacts on the RS5100 assembly with the contacts on the back of hand mount and engage the slot (located at the top of the RS5100 on the backside) on the RS5100 with the opening at the top of the back of hand mount.

**Figure 72** Align the Contacts and Engage the Slot



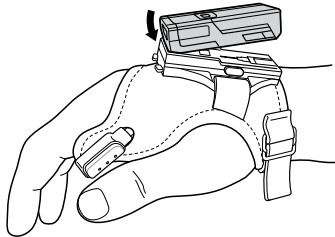
2. Push down on the RS5100 to snap into place.

**Figure 73** Push Down

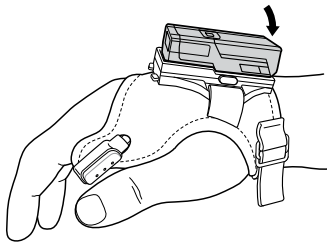


## Correct Installation

**Figure 74** Correct: Align Top of Device

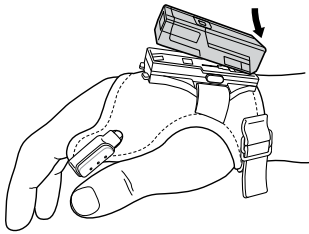


**Figure 75** Correct: Push Down on Bottom of Device

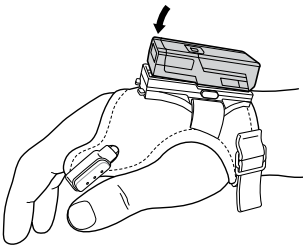


## Incorrect Installation

**Figure 76** Incorrect: Align Bottom of Device



**Figure 77** Incorrect: Push Down on Top of Device

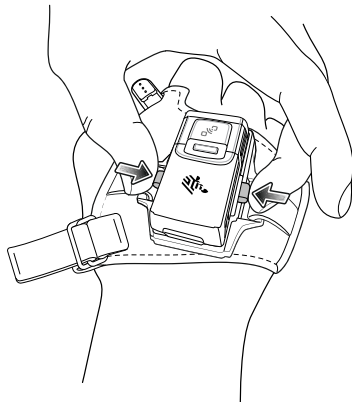


## Detach RS5100

To detach the RS5100 from the back of hand mount:

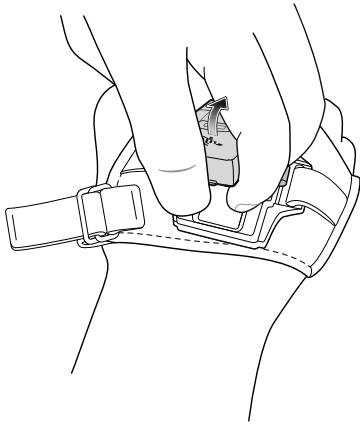
1. Press the release buttons on both sides of the back of hand mount using your thumb and middle finger.

**Figure 78** Press Release Buttons



2. Lift the RS5100 off the back of hand mount using your index finger.

**Figure 79** Lift the Device



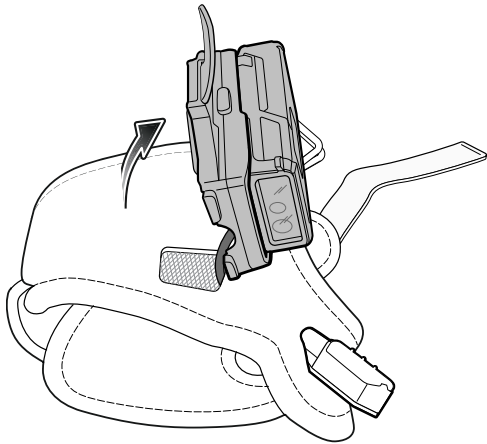
## Cleaning the Glove

Before cleaning the glove, you must remove the electronics from the glove.

To remove the electronics from the glove:

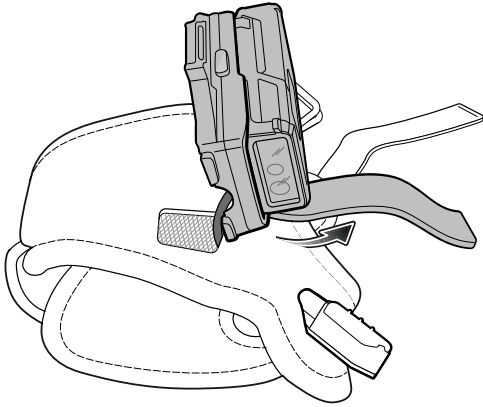
1. Unfasten the strap and detach the mount holding the RS5100

**Figure 80** Unfasten the Strap and Detach Mount



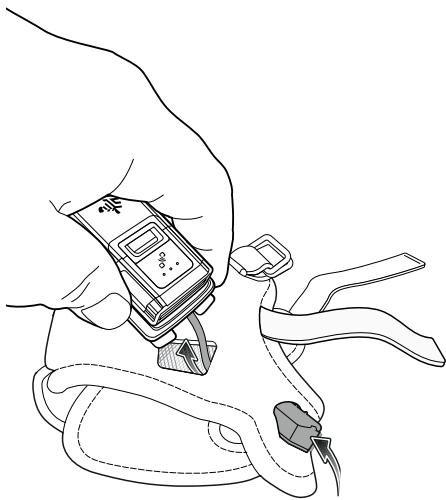
2. Slide the mount off the strap.

**Figure 81** Slide Mount Off Strap



3. Remove the finger trigger button and cable from the glove.

**Figure 82** Remove Finger Trigger Button and Cable from Glove



4. Use an approved cleaning agent or mild detergent on the glove material only and air dry.

# RS5100 Configuration and Update

---

## Introduction

This chapter describes:

- Configuring the RS5100
- Debugging logger
- Upgrading Firmware.

---

## Configuring the RS5100

### Introduction

The RS5100 is provided with a default software configuration set in the factory. This software configuration can be optimized by the customer to meet their specific operational requirements. Therefore, before using the RS5100, it is essential to properly configure the RS5100 to harness its extensive capabilities and gain maximum efficiency.

Configure the RS5100 by scanning special configuration barcodes or via the 123Scan<sup>2</sup> application. When the RS5100 is connected to a Zebra mobile computer, some of the RS5100 configuration parameters can be automatically overwritten by an EMDK application or DataWedge.



**NOTE:** A warm boot should be performed to reset the RS5100 after scanning the configuration barcodes.

Once the RS5100 is paired to a Zebra host device, the scanning software will disable the ability to read the configuration barcodes.

### DataWedge

DataWedge is an application available on Zebra mobile computers. DataWedge is used to configure scanner settings and process scanned data before sending to an application.

DataWedge is based on profiles. A profile contains information on how DataWedge should behave with different applications. Using profiles, each application can have a specific DataWedge configuration. For example, each user application can have a profile which outputs scanned data in the required format when that application comes to the foreground. DataWedge can be configured to process the same set of captured data differently based on the requirements of each application.

Once connected to a Zebra mobile computer, DataWedge settings override some of the RS5100 parameters previously set via configuration barcodes or 123Scan<sup>2</sup>. These settings only apply while the RS5100 is connected to the Zebra mobile computer, and do not persist once the RS5100 has been disconnected and reset.

For more information on DataWedge, refer to WT6000 Integrator Guide, p/n MN-002699-xx.

## 123Scan<sup>2</sup>

123Scan<sup>2</sup> is a PC-based software tool that enables rapid customized setup of the device.

123Scan<sup>2</sup> uses a wizard tool to guide users through a streamlined set up process. Settings are saved in a configuration file that can be distributed via e-mail or used to generate a sheet of programming barcodes.

123Scan<sup>2</sup> can upgrade the device firmware, check on-line to enable support for newly released products, generate a collection of multi-setting barcodes if the number of settings is very large, and generate reports with asset tracking information.

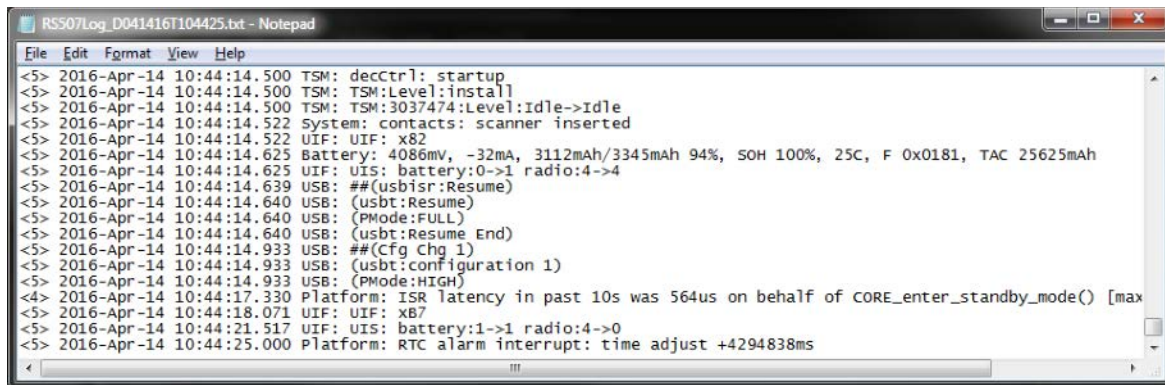
For more information on 123Scan<sup>2</sup>, see [123Scan and Software Tools](#).

## Real Time Logger

The RS5100 includes a Real Time Logger application that logs events, errors, exceptions and software diagnostics of the RS5100 during its operation. Each log record has a time stamp with a 1 ms resolution. The log record memory size is 4 MB and operates in a cyclic way. Log records reset after cold or clean boot.

[Figure 83](#) shows the Real Time Logger file content as shown on a host computer screen.

**Figure 83** Real Time Logger Content Screen



```

RSS07Log_D041416T104425.txt - Notepad
File Edit Format View Help
<5> 2016-Apr-14 10:44:14.500 TSM: decCtrl: startup
<5> 2016-Apr-14 10:44:14.500 TSM: TSM:Level:install
<5> 2016-Apr-14 10:44:14.500 TSM: TSM:3037474:Level:Idle->Idle
<5> 2016-Apr-14 10:44:14.522 System: contacts: scanner inserted
<5> 2016-Apr-14 10:44:14.522 UIF: UIF: x82
<5> 2016-Apr-14 10:44:14.625 Battery: 4086mv, -32mA, 3112mAh/3345mAh 94%, SOH 100%, 25C, F 0x0181, TAC 25625mAh
<5> 2016-Apr-14 10:44:14.625 UIF: UIS: battery:0->1 radio:4->4
<5> 2016-Apr-14 10:44:14.639 USB: ##(usbisr:Resume)
<5> 2016-Apr-14 10:44:14.640 USB: (usbt:Resume)
<5> 2016-Apr-14 10:44:14.640 USB: (Pmode:FULL)
<5> 2016-Apr-14 10:44:14.640 USB: (usbt:Resume End)
<5> 2016-Apr-14 10:44:14.933 USB: ##(cfg Chg 1)
<5> 2016-Apr-14 10:44:14.933 USB: (usbt:configuration 1)
<5> 2016-Apr-14 10:44:14.933 USB: (Pmode:HIGH)
<4> 2016-Apr-14 10:44:17.330 Platform: ISR latency in past 10s was 564us on behalf of CORE_enter_standby_mode() [max
<5> 2016-Apr-14 10:44:18.071 UIF: UIF: xB7
<5> 2016-Apr-14 10:44:21.517 UIF: UIS: battery:1->1 radio:4->0
<5> 2016-Apr-14 10:44:25.000 Platform: RTC alarm interrupt: time adjust +4294838ms
  
```

## Retrieving the RS5100 Log File

The RS5100 log file is retrieved using a host computer, USB trigger and the RS507PCTool application.

The RS507PCTool application requires the Scanner CDC driver be installed on the host computer. This driver creates a virtual COM port (Scanner Virtual COM Port) when the RS6000 is connected to a host computer via USB. Both RS507PCTool and the Scanner USB CDC driver are available for download from [zebra.com/support](http://zebra.com/support).



**SSI over USB CDC (non-persistent)**

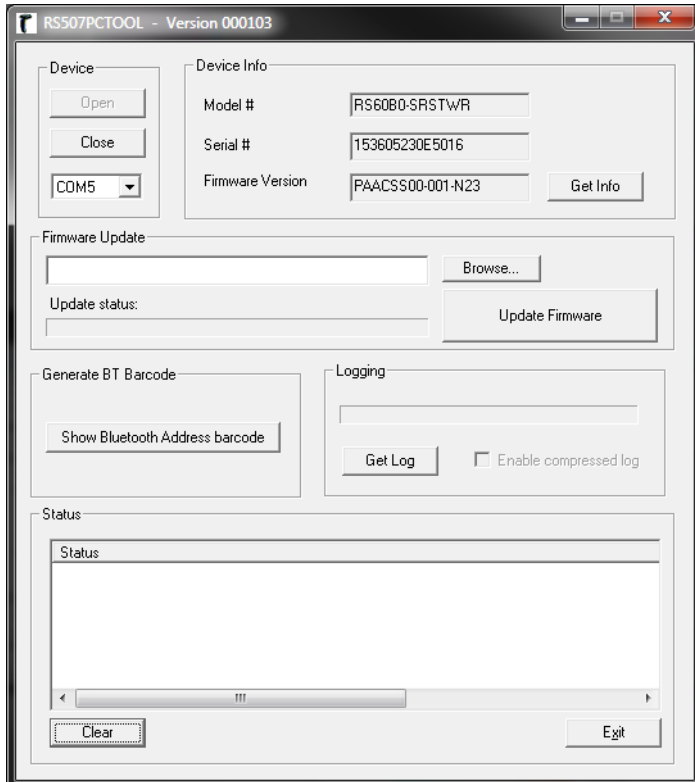
To obtain log messages over a USB connection:

1. Scan the **SSI over USB CDC** bar code to switch the RS5100 USB connection from SNAPI to CDC / SSI.
2. Connect the RS5100 to the host computer via the USB trigger.

3. Open the RS507PCTool application.
4. In the **Device** section, click **Open**. The virtual COM port assigned to the RS5100 opens and the **Device Info** for the RS5100 will be shown.

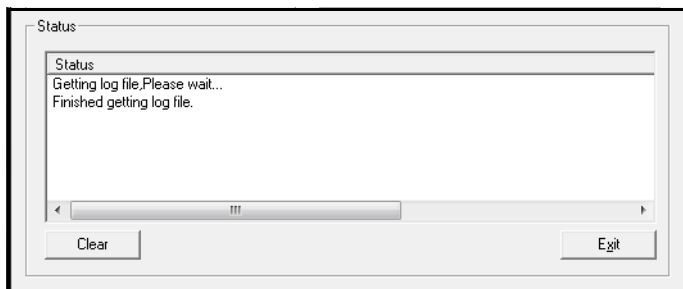
When the RS5100 is connected to the RS507PCTool, the logger time on the RS5100 is synchronized with the host computer's time.

**Figure 84** RS507PCTool



5. Click **Get Log**.
6. The log file is saved in the same directory on the host computer where RS507PCTool application is located.

**Figure 85** RS507PCTool Finished Getting Log File



7. The log file name format is RS507Log\_D<date&time>.txt

## RS5100 Firmware Update

RS5100 devices can be upgraded and re-flashed with a new firmware. The update is performed by downloading the firmware to the RS5100 flash memory. If download fails, the previous firmware remains operational. The



firmware remains inside the RS5100 memory even when powering the RS5100 off/on (removing and re-installing the battery).

The RS5100 firmware can be updated by:

- Bluetooth using 123Scan<sup>2</sup>
- Bluetooth connected Zebra device.

### Bluetooth Using 123Scan<sup>2</sup>

The 123Scan<sup>2</sup> application can upgrade the RS5100 firmware using Bluetooth to connect to a host computer. For more information on using 123Scan<sup>2</sup> see [123Scan and Software Tools](#).

### Bluetooth Connected Zebra Device

The Zebra WT6000 or later device provides Enterprise Mobility Developer Kit (EMDK) support for updating the firmware of a Bluetooth connected RS5100. Using a Mobile Device Management (MDM) application, RS5100 firmware is deployed to the WT6000 device. Then an EMDK application must be created which downloads the firmware to the RS5100.

To update the RS5100 firmware by using the Zebra Device Central app (version 2.1.0.14 or later):

1. Deploy the firmware update to the Zebra host device in the location:  
**\\Internal shared storage\Android\data\com.symbol.devicecentral\files**
2. Open the Device Central app, and pair the RS5100.
3. Tap the RS5100 item to show the device details.
4. Tap the **Firmware update** button.

# Miscellaneous Imager Options

## Introduction

You can program the RS5100 to perform various functions, or activate different features. This chapter describes each user preference feature and provides programming barcodes for selecting these features.

The RS5100 ships with the settings shown in [Table 7 on page 114](#) (also see [Standard Default Parameters](#) for all defaults). If the default values suit requirements, programming is not necessary.

To set feature values, scan a single barcode or a short barcode sequence. The settings are stored in non-volatile memory and are preserved even when the RS5100 is powered down.



**NOTE:** Most computer monitors allow scanning the barcodes directly on the screen. When scanning from the screen, be sure to set the document magnification to a level where you can see the barcode clearly, and bars and/or spaces are not merging.

To return all features to default values, see [Default Parameters on page 116](#). Throughout the programming barcode menus, asterisks indicate (\*) default values.



\* Indicates Default — \*Enable Parameter — Feature/Option  
(1) — Option Value

## Scanning Sequence Examples

In most cases, scanning one barcode sets the parameter value. For example, to set the beeper tone to high, scan the **High Frequency** (beeper tone) barcode listed under [Beeper Tone on page 120](#). The RS5100 issues a fast warble beep and the LED turns green, signifying a successful parameter entry.

Other parameters, such as **Data Transmission Formats**, require scanning several barcodes. See these parameter descriptions for this procedure.

## Errors While Scanning

Unless otherwise specified, to correct an error during a scanning sequence, just re-scan the correct parameter.

## User Preferences/Miscellaneous Options Parameter Defaults

[Table 7](#) lists defaults for user preferences parameters. To change the default values:

- Scan the appropriate barcodes in this guide. These new values replace the standard default values in memory. To recall the default parameter values, see [Default Parameters on page 116](#).
- Configure the RS5100 using the 123Scan<sup>2</sup> configuration program (see [123Scan2 on page 110](#)).



**NOTE:** See [Standard Default Parameters](#) for all user preferences, hosts, symbologies, and miscellaneous default parameters.

**Table 7** User Preferences Parameter Defaults

Parameter	Parameter Number <sup>1</sup>	SSI Number <sup>2</sup>	Default	Page Number
User Preferences				
Set Default Parameter			Restore Defaults	<a href="#">116</a>
Parameter Barcode Scanning	236	ECh	Enable	<a href="#">117</a>
Beep After Good Decode	56	38h	Enable	<a href="#">118</a>
Beep on Insertion	288		Enabled	<a href="#">118</a>
Beeper Volume	140	8Ch	High	<a href="#">119</a>
Beeper Tone	145	91h	High	<a href="#">120</a>
Beeper Duration	628	F1h 74h	Short	<a href="#">121</a>
Suppress Power Up Beeps	721	F1h D1h	Do Not Suppress	<a href="#">121</a>
Low Battery Indication	779	F2h 08h	Enable	<a href="#">122</a>
Hand-Held Trigger Mode	138	8Ah	Level	<a href="#">123</a>

1. Parameter number decimal values are used for programming via RSM commands.

2. SSI number hex values are used for programming via SSI commands.

**Table 7** User Preferences Parameter Defaults (Continued)

Parameter	Parameter Number <sup>1</sup>	SSI Number <sup>2</sup>	Default	Page Number
Hand-Held Decode Aiming Pattern	306	F0h 32h	Enable	124
Picklist Mode	402	F0h 92h	Disabled Always	125
Continuous Barcode Read	649	F1h 89h	Disable	126
Unique Barcode Reporting	723	F1h D3h	Enable	127
Decode Session Timeout	136	88h	9.9 Sec	128
Timeout Between Decodes, Same Symbol	137	89h	0.5 Sec	129
Timeout Between Decodes, Different Symbols	144	90h	0.1 sec	130
Fuzzy 1D Processing	514	F1h 02h	Enable	130
Decode Mirror Images (Data Matrix Only)	537	F1h 19h	Auto	131
PDF Prioritization	719	F1h CFh	Disable	133
PDF Prioritization Timeout	720	F1h D0h	200 ms	133
Decoding Illumination	298	F0h 2Ah	Enable	135
Motion Tolerance	858	F2h 5Ah	Less Motion Tolerance	136
<b>Miscellaneous Options</b>				
Add an Enter Key	N/A	N/A	N/A	136
Transmit Code ID Character	45	2Dh	None	136
Prefix Value	99, 105	63h, 69h	7013 <CR><LF>	137
Suffix 1 Value	98, 104	62h, 68h	7013 <CR><LF>	137
Suffix 2 Value	100, 106	64h, 6Ah		
Scan Data Transmission Format	235	EBh	Data as is	138
FN1 Substitution Values	103, 109	67h, 6Dh	7013 <CR><LF>	140
Transmit "No Read" Message	94	5E	Disable	141
Trigger Buttons Enabled	2068	F8h 08h 14h	Enable	141

1. Parameter number decimal values are used for programming via RSM commands.

2. SSI number hex values are used for programming via SSI commands.

## User Preferences

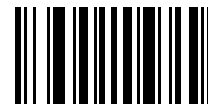
### Default Parameters

The RS5100 can be reset to two types of defaults: factory defaults or custom defaults. Scan the appropriate barcode below to reset the RS5100 to its default settings and/or set the RS5100 current settings as the custom default.

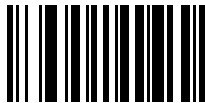
- **Restore Defaults** - Resets all default parameters as follows:
  - If custom default values were configured (see **Write to Custom Defaults**), the custom default values are set for all parameters each time the **Restore Defaults** barcode below is scanned.
  - If no custom default values were configured, the factory default values are set for all parameters each time the **Restore Defaults** barcode below is scanned. (For factory default values, see [Standard Default Parameters.](#))
- **Set Factory Defaults** - Scan the **Set Factory Defaults** barcode below to eliminate all custom default values and set the RS5100 to factory default values (For factory default values, see [Standard Default Parameters](#)).
- **Write to Custom Defaults** - Custom default parameters can be configured to set unique default values for all parameters. After changing all parameters to the desired default values, scan the **Write to Custom Defaults** barcode below to configure custom defaults.



\*Restore Defaults



Set Factory Defaults



Write to Custom Defaults

## Parameter Barcode Scanning

### Parameter # 236 (SSI # ECh)

To disable the decoding of parameter barcodes, including the **Set Defaults** parameter barcodes, scan the **Disable Parameter Scanning** barcode below. To enable decoding of parameter barcodes, scan **Enable Parameter Scanning**.



**\*Enable Parameter Barcode Scanning  
(1)**



**Disable Parameter Barcode Scanning  
(0)**

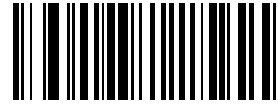
## Beep After Good Decode

### Parameter # 56 (SSI # 38h)

Scan a barcode below to select whether or not the RS5100 beeps after a good decode. If selecting **Do Not Beep After Good Decode**, the beeper still operates during parameter menu scanning and to indicate error conditions.



**\*Beep After Good Decode (Enable)**  
(1)



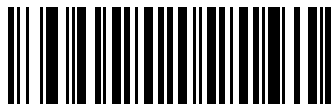
**Do Not Beep After Good Decode (Disable)**  
(0)

## Beep on Insertion

### Parameter # 288

When the RS5100 is inserted into a cradle and detects power, it emits a short low beep. This feature is enabled by default.

To enable or disable beeping on insertion, scan the appropriate barcode below.



**\*Enable Beep on Insertion**  
(00h)



**Disable Beep on Insertion**  
(01h)

## Beeper Volume

### Parameter # 140 (SSI # 8Ch)

To select a beeper volume, scan the **Low Volume**, **Medium Volume**, or **High Volume** barcode.



**Low Volume**  
(2)



**Medium Volume**  
(1)



**\*High Volume**  
(0)



## Beeper Tone

### Parameter # 145 (SSI # 91h)

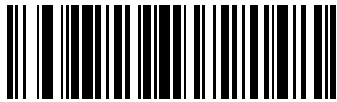
To select a beeper tone, scan one of the following barcodes.



Off  
(3)



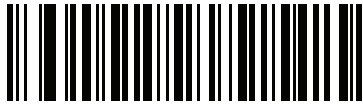
Low Tone  
(2)



Medium Tone  
(1)



\* High Tone  
(0)



Medium to High Tone (2-tone)  
(4)

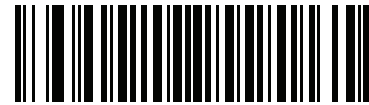
## Beeper Duration

### Parameter # 628 (SSI # F1h 74h)

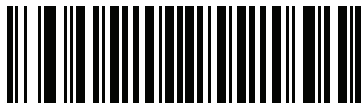
To select the duration for the beeper, scan one of the following barcodes.



**\* Short  
(0)**



**Medium  
(1)**

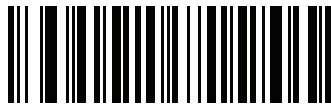


**Long  
(2)**

## Suppress Power Up Beeps

### Parameter # 721 (SSI # F1h D1h)

Scan a barcode below to select whether or not to suppress the RS5100 power-up beeps.



**\*Do Not Suppress Power Up Beeps  
(0)**



**Suppress Power Up Beeps  
(1)**

## Low Battery Indication

### Parameter # 779 (SSI # F2h 0Bh)

Scan a barcode below to select whether or not to suppress the RS5100's low battery indication.



**Disable**  
**(0)**



**\*Enable**  
**(1)**

## Hand-Held Trigger Mode

### Parameter # 138 (SSI # 8Ah)

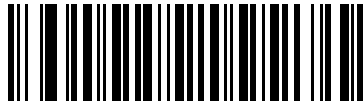
Select one of the following trigger modes for the RS5100.

- **Standard (Level)** - A trigger pull activates decode processing. Decode processing continues until the barcode decodes, you release the trigger, or the [Decode Session Timeout on page 128](#) occurs.
- **Two Stage:**
  - **Option 1** - This trigger mode presents the laser aiming guide when you press and hold the trigger. Releasing the trigger activates decode processing.
  - **Option 2** - This trigger mode projects the laser aiming guide on the first trigger press. A second trigger press within a short period of time activates decode processing.

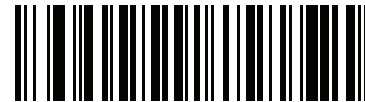


**NOTE:** Hand-held Trigger Mode is not supported for triggerless models and should be left at its default value.

When configured for Bluetooth SSI mode, the triggering mode is controlled by the Zebra Mobile Computer and this setting should be left at its default value.



\*Level (Standard)  
(0)



Two Stage - Option 1  
(14)



Two Stage - Option 2  
(15)

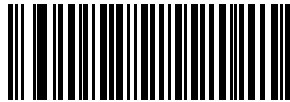
## Hand-Held Decode Aiming Pattern

### Parameter # 306 (SSI # F0h 32h)

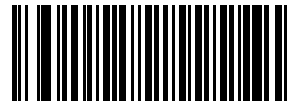
Select **Enable Hand-Held Decode Aiming Pattern** to project the aiming dot during barcode capture, **Disable Hand-Held Decode Aiming Pattern** to turn the aiming dot off, or **Enable Hand-Held Decode Aiming Pattern on PDF** to project the aiming dot when the RS5100 detects a 2D barcode.



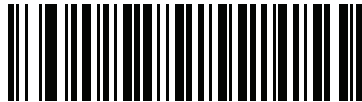
**NOTE:** With [Picklist Mode on page 125](#) enabled, the decode aiming dot flashes even when the **Hand-Held Decode Aiming Pattern** is disabled.



**\*Enable Hand-Held Decode Aiming Pattern  
(2)**



**Disable Hand-Held Decode Aiming Pattern  
(0)**



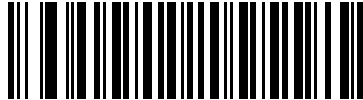
**Enable Hand-Held Decode Aiming Pattern on PDF  
(3)**

## Picklist Mode

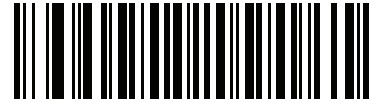
### Parameter # 402 (SSI # F0h 92h)

Picklist mode enables the RS5100 to decode only barcodes that are aligned under the LED aiming dot. Select one of the following picklist modes for the RS5100:

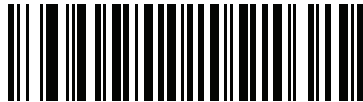
- **Disabled Always** - Picklist mode is always disabled.
- **Enabled in Hand-Held Mode** - Picklist mode is enabled in hand-held mode.



**\*Disabled Always**  
**(0)**



**Enabled in Hand-Held Mode**  
**(1)**



**Enabled Always**  
**(2)**



**NOTE:** Picklist Mode temporarily overrides the Disable Decode Aiming Pattern parameter. You can not disable the decode aiming pattern when Picklist Mode is enabled.

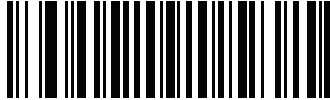
## Continuous Barcode Read

### Parameter # 649 (SSI # F1h 89h)

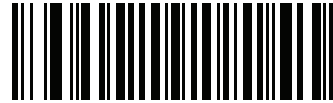
Enable this to report every barcode while the trigger is pulled.



**NOTE:** Zebra strongly recommends enabling [Picklist Mode on page 125](#) with this feature. Disabling Picklist Mode can cause accidental decodes when more than one barcode is in the RS5100's field of view.



**\*Disable Continuous Barcode Read  
(0)**



**Enable Continuous Barcode Read  
(1)**

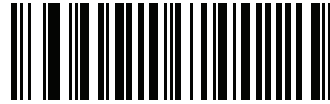
## Unique Barcode Reporting

### Parameter # 723 (SSI # F1h D3h)

Enable this to report only unique barcodes while the trigger is pulled. This option only applies when **Continuous Barcode Read** is enabled.



**Disable Continuous Barcode Read Uniqueness**  
(0)



**\*Enable Continuous Barcode Read Uniqueness**  
(1)



## Decode Session Timeout

### Parameter # 136 (SSI # 88h)

This parameter sets the maximum time decode processing continues during a scan attempt. It is programmable in 0.1 second increments from 0.5 to 9.9 seconds. The default timeout is 9.9 seconds.

To set a Decode Session Timeout, scan the barcode below. Next, scan two numeric barcodes from [Alphanumeric and Numeric Barcodes](#) that correspond to the desired on time. Enter a leading zero for single digit numbers. For example, to set a Decode Session Timeout of 0.5 seconds, scan the barcode below, then scan the **0** and **5** barcodes. To correct an error or change the selection, scan [Cancel on page 325](#).



**Decode Session Timeout**

## Timeout Between Decodes, Same Symbol

### Parameter # 137 (SSI # 89h)

Use this option in Continuous Barcode Read mode to prevent the beeper from continuously beeping when a barcode is left in the RS5100 field of view. The barcode must be out of the field of view for the timeout period before the RS5100 reads the same consecutive barcode. It is programmable in 0.1 second increments from 0.0 to 9.9 seconds. The default interval is 0.5 seconds.

To select the timeout between decodes for the same barcode, scan the barcode below, then scan two numeric barcodes from [Alphanumeric and Numeric Barcodes](#) that correspond to the desired interval, in 0.1 second increments.



**Timeout Between Decodes, Same Symbol**

## Timeout Between Decodes, Different Symbol

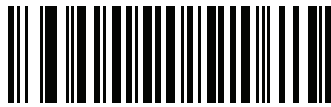
### Parameter # 144 (SSI # 90h)

Use this option in presentation mode or Continuous Barcode Read to control the time the RS5100 is inactive between decoding different barcodes. It is programmable in 0.1 second increments from 0.1 to 9.9 seconds. The default is 0.1 seconds.

To select the timeout between decodes for different barcodes, scan the barcode below, then scan two numeric barcodes from [Alphanumeric and Numeric Barcodes](#) that correspond to the desired interval, in 0.1 second increments.



**NOTE:** Timeout Between Decodes, Different Symbols cannot be greater than or equal to the Decode Session Timeout.



Timeout Between Decodes, Different Symbols

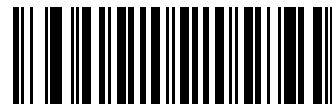
## Fuzzy 1D Processing

### Parameter # 514 (SSI # F1h 02h)

This option is enabled by default to optimize decode performance on 1D barcodes, including damaged and poor quality barcodes. Disable this only if you experience time delays when decoding 2D barcodes, or in detecting a no decode.



\*Enable Fuzzy 1D Processing  
(1)



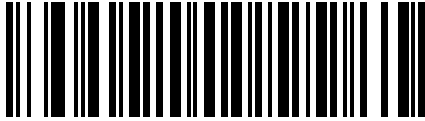
Disable Fuzzy 1D Processing  
(0)

## Decode Mirror Images (Data Matrix Only)

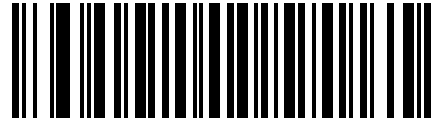
### Parameter # 537 (SSI # F1h 19h)

Select an option for decoding mirror image Data Matrix barcodes:

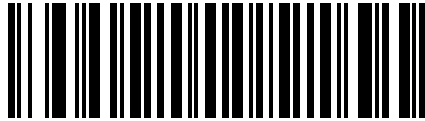
- Always - decode only Data Matrix barcodes that are mirror images
- Never - do not decode Data Matrix barcodes that are mirror images
- Auto - decode both mirrored and un-mirrored Data Matrix barcodes.



**Never**  
(0)



**Always**  
(1)



**\*Auto**  
(2)

## Mobile Phone/Display Mode

### Parameter # 716 (SSI # F1h CCh)

This mode improves barcode reading performance off mobile phones and electronic displays. Select Enhanced in hand-held or select Normal Mobile Phone/Display Mode.



**\*Normal Mobile Phone/Display Mode  
(0)**



**Enhanced in Hand-Held Mode  
(1)**

## PDF Prioritization

### Parameter # 719 (SSI # F1h CFh)

Enable this feature to delay decoding a 1D barcode (Code 128) by the value specified in [PDF Prioritization Timeout](#). During that time the RS5100 attempts to decode a PDF417 symbol (e.g., on a US driver's license), and if successful, reports this only. If it does not decode (can not find) a PDF417 symbol, it reports the 1D symbol after the timeout. The 1D symbol must be in the device's field of view for the RS5100 to report it. This parameter does not affect decoding other symbologies..

**NOTE:**

The 1D Code 128 barcode lengths include the following:

- 7 to 10 characters
- 14 to 17 characters
- 27 to 28 characters

In addition, a Code 39 barcode with the following lengths are considered to potentially be part of a US driver's license:

- 8 characters
- 12 characters



**\*Disable PDF Prioritization  
(0)**



**Enable PDF Prioritization  
(1)**

## PDF Prioritization Timeout

### Parameter # 720 (SSI # F1h D0h)

When [PDF Prioritization](#) is enabled, this timeout specifies how long the RS5100 attempts to decode a PDF417 symbol before reporting the 1D barcode in the field of view.

Scan the following barcode, then scan four digits from [Alphanumeric and Numeric Barcodes](#) that specify the timeout in milliseconds. For example, to enter 400 ms, scan the following barcode, then scan 0400. The range is 0 to 5000 ms, and the default is 200 ms.



PDF Prioritization Timeout

## Decoding Illumination

### Parameter # 298 (SSI # F0h 2Ah)

Selecting **Enable Decoding Illumination** causes the RS5100 to flash illumination to aid decoding. Select **Disable Decoding Illumination** to prevent the RS5100 from using decoding illumination.

Enabling illumination usually results in superior barcode reading performance. The effectiveness of the illumination decreases as the distance to the target increases.



**\*Enable Decoding Illumination**  
**(1)**



**Disable Decoding Illumination**  
**(0)**



## Motion Tolerance

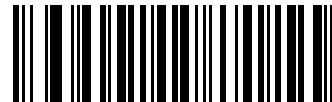
### Parameter # 858 (SSI # F2h 5Ah)

**Less Motion Tolerance** provides optimal decoding performance on 1D barcodes.

To increase motion tolerance and speed decoding when scanning a series of 1D barcodes in rapid progression, scan **More Motion Tolerance**.



**\*Less Motion Tolerance  
(0)**



**More Motion Tolerance  
(1)**

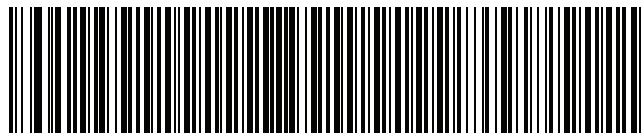
---

## Miscellaneous Scanner Parameters

### Add an Enter Key

To add an Enter key (carriage return/line feed) after scanned data, scan the following barcode.

To program other prefixes and/or suffixes, see [Prefix/Suffix Values on page 137](#).



**Add Enter Key (Carriage Return/Line Feed)**

### Transmit Code ID Character

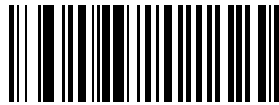
#### Parameter # 45 (SSI # 2Dh)

A Code ID character identifies the code type of a scanned barcode. This is useful when decoding more than one code type. In addition to any single character prefix already selected, the Code ID character is inserted between the prefix and the decoded symbol.

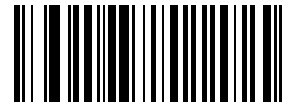
Select no Code ID character, a Symbol Code ID character, or an AIM Code ID character. For Code ID characters, see [Programming Reference on page 318](#).



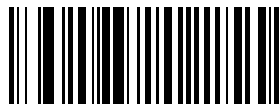
**NOTE:** If you enable Symbol Code ID Character or AIM Code ID Character, and enable [Transmit “No Read” Message on page 141](#), the RS5100 appends the code ID for Code 39 to the NR message.



Symbol Code ID Character  
(2)



AIM Code ID Character  
(1)



\*None  
(0)

### Prefix/Suffix Values

**Key Category Parameter # P = 99, S1 = 98, S2 = 100 (SSI # P = 63h, S1 = 62h, S2 = 64h)**

**Decimal Value Parameter # P = 105, S1 = 104, S2 = 106 (SSI # P = 69h, S1 = 68h, S2 = 6Ah)**

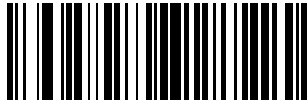
You can append a prefix and/or one or two suffixes to scan data for use in data editing. To set a value for a prefix or suffix, scan a four-digit number (i.e., four barcodes from [Alphanumeric and Numeric Barcodes](#)) that corresponds to that value. See [ASCII Character Sets](#) for the four-digit codes.

When using host commands to set the prefix or suffix, set the key category parameter to 1, then set the 3-digit decimal value. See [ASCII Character Sets](#) for the four-digit codes.

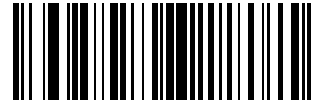
The default prefix and suffix value is 7013 <CR><LF> (the Enter key). To correct an error or change a selection, scan [Cancel on page 325](#).



**NOTE:** To use Prefix/Suffix values, first set the [Scan Data Transmission Format on page 138](#).



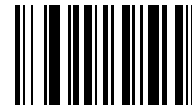
**Scan Prefix  
(7)**



**Scan Suffix 1  
(6)**



**Scan Suffix 2  
(8)**



**Data Format Cancel**

## Scan Data Transmission Format

### Parameter # 235 (SSI # EBh)

To change the scan data format, scan one of the following eight barcodes corresponding to the desired format.



**NOTE:** If using this parameter do not use ADF rules to set the prefix/suffix.

To set values for the prefix and/or suffix, see [Prefix/Suffix Values on page 137](#).



**\*Data As Is  
(0)**



**<DATA> <SUFFIX 1>  
(1)**



**<DATA> <SUFFIX 2>  
(2)**



**<DATA> <SUFFIX 1> <SUFFIX 2>  
(3)**



**<PREFIX> <DATA >  
(4)**

## Scan Data Transmission Format (continued)



<PREFIX> <DATA> <SUFFIX 1>  
(5)



<PREFIX> <DATA> <SUFFIX 2>  
(6)



<PREFIX> <DATA> <SUFFIX 1> <SUFFIX 2>  
(7)

## FN1 Substitution Values

### Key Category Parameter # 103 (SSI # 67h)

### Decimal Value Parameter # 109 (SSI # 6Dh)

The wedge and USB HID keyboard hosts support a FN1 Substitution feature. Enabling this substitutes any FN1 character (0x1b) in an EAN128 barcode with a value. This value defaults to 7013 (Enter Key).

When using host commands to set the FN1 substitution value, set the key category parameter to 1, then set the 3-digit keystroke value. See the ASCII Character Set table for the current host interface for the desired value.

To select a FN1 substitution value via barcode menus:

1. Scan the barcode below.



**Set FN1 Substitution Value**

2. Locate the keystroke desired for FN1 Substitution in the ASCII Character Set table for the current host interface. Enter the 4-digit ASCII Value by scanning each digit in [Alphanumeric and Numeric Barcodes](#).

To correct an error or change the selection, scan **Cancel**.

To enable FN1 substitution for USB HID keyboard, scan the **Enable FN1 Substitution** barcode on page 42.

## Transmit “No Read” Message

### Parameter # 94 (SSI # 5Eh)

Scan a barcode below to select whether or not to transmit a No Read message. Enable this to transmit the characters NR when a successful decode does not occur before trigger release or the **Decode Session Timeout** expires. See [Decode Session Timeout on page 128](#). Disable this to send nothing to the host if a symbol does not decode.



**NOTE:** If you enable **Transmit No Read**, and also enable Symbol Code ID Character or AIM Code ID Character for [Transmit Code ID Character on page 136](#), the RS5100 appends the code ID for Code 39 to the NR message.



**Enable No Read  
(1)**



**\*Disable No Read  
(0)**

## Trigger Buttons Enabled

### Parameter # 2068 (SSI# F8h 08h 14h)

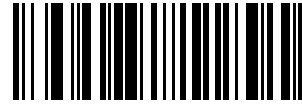
The trigger buttons on RS5100 can be enabled or disabled using the following barcodes. Please make sure to use the correct barcode appropriate for the type of trigger module mounted on the RS5100. In case of a misconfiguration, doing a clean boot will restore the default state of triggers.

#### RS5100 with single trigger module

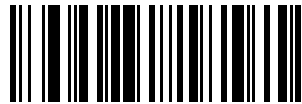
The default value enables the top trigger and the single trigger – whether it's rotated to be left trigger or rotated to be the right trigger.



**\* Top Trigger and Single Trigger Enabled**



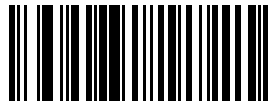
**Single Trigger Only Enabled**



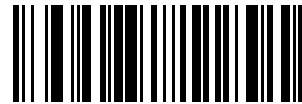
**Top Trigger Only Enabled**

**RS5100 with double trigger module**

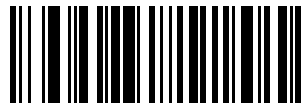
The default value enables all the triggers available - the top trigger, the left trigger and the right trigger.



**\* Top Trigger, Left Trigger, and Right Trigger Enabled**



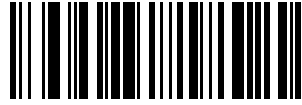
**Left Trigger Only**



**Right Trigger Only**



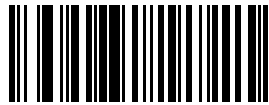
**Top Trigger Only**



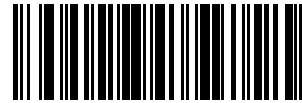
**Left Trigger and Right Trigger**

**RS5100 with Lanyard or Back-Of-Hand mount.**

The default value enables the Lanyard/Back-of-Hand mount trigger, but disables the top trigger.



**\* Lanyard/Back of Hand Mount Trigger Enabled**



**Top Trigger and Lanyard/Back of Hand Mount  
Trigger Enabled**



# Symbologies

---

## Introduction

This chapter describes symbology features and provides programming barcodes for selecting these features. To set feature values, scan a single barcode or a short barcode sequence. The settings are stored in non-volatile memory and are preserved even when the RS5100 powers down.



**NOTE:** Most computer monitors allow scanning the barcodes directly on the screen. When scanning from the screen, be sure to set the document magnification to a level where you can see the barcode clearly, and bars and/or spaces do not merge.

Select a host type (see each host chapter for specific host information) after the power-up beeps sound. This is only necessary upon the first power-up when connected to a new host.

To return all features to default values, see [Default Parameters on page 116](#). Throughout the programming barcode menus, asterisks (\*) indicate default values.



\* Indicates Default      \*Enable Parameter      Feature/Option  
(1)      Option Value

---

## Scanning Sequence Examples

In most cases, scanning one barcode sets the parameter value. For example, to transmit barcode data without the UPC-A check digit, simply scan the **Do Not Transmit UPC-A Check Digit** barcode under [Transmit UPC-A Check Digit on page 160](#). The RS5100 issues a fast warble beep and the LED turns green, signifying a successful parameter entry.

Other parameters, such as **Set Length(s) for D 2 of 5** require scanning several barcodes. See the individual parameter, such as **Set Length(s) for D 2 of 5**, for this procedure.

---

## Errors While Scanning

Unless otherwise specified, to correct an error during a scanning sequence, just re-scan the correct parameter.

## Symbology Parameter Defaults

Table 8 lists the defaults for all symbology parameters. To change the default values, scan the appropriate barcodes in this guide. These new values replace the standard default values in memory. To recall the default parameter values, see [Default Parameters on page 116](#).



**NOTE:** See [Standard Default Parameters](#) for all user preferences, hosts, and miscellaneous default parameters.

**Table 8** Symbology Parameter Defaults

Parameter	Parameter Number	SSI Number	Default	Page Number
<b>Enable/Disable All Code Types</b>				<a href="#">151</a>
<b>1D Symbologies</b>				
<b>UPC/EAN</b>				
UPC-A	1	01h	Enable	<a href="#">152</a>
UPC-E	2	02h	Enable	<a href="#">152</a>
UPC-E1	12	0Ch	Disable	<a href="#">153</a>
EAN-8/JAN 8	4	04h	Enable	<a href="#">153</a>
EAN-13/JAN 13	3	03h	Enable	<a href="#">154</a>
Bookland EAN	83	53h	Disable	<a href="#">154</a>
Decode UPC/EAN/JAN Supplementals (2 and 5 digits)	16	10h	Ignore	<a href="#">156</a>
User-Programmable Supplementals			000	<a href="#">158</a>
Supplemental 1:	579	F1h 43h		
Supplemental 2:	580	F1h 44h		
UPC/EAN/JAN Supplemental Redundancy	80	50h	10	<a href="#">158</a>
Decode UPC/EAN/JAN Supplemental AIM ID	672	F1h A0h	Combined	<a href="#">159</a>
UPC Reduced Quiet Zone	1289	F8h 05h 09h	Disable	<a href="#">160</a>
Transmit UPC-A Check Digit	40	28h	Enable	<a href="#">160</a>
Transmit UPC-E Check Digit	41	29h	Enable	<a href="#">161</a>
Transmit UPC-E1 Check Digit	42	2Ah	Enable	<a href="#">161</a>
UPC-A Preamble	34	22h	System Character	<a href="#">162</a>
UPC-E Preamble	35	23h	System Character	<a href="#">163</a>
UPC-E1 Preamble	36	24h	System Character	<a href="#">164</a>
Convert UPC-E to A	37	25h	Disable	<a href="#">165</a>

**Table 8** Symbology Parameter Defaults (Continued)

Parameter	Parameter Number	SSI Number	Default	Page Number
Convert UPC-E1 to A	38	26h	Disable	<a href="#">165</a>
EAN-8/JAN-8 Extend	39	27h	Disable	<a href="#">166</a>
Bookland ISBN Format	576	F1h 40h	ISBN-10	<a href="#">167</a>
UCC Coupon Extended Code	85	55h	Disable	<a href="#">168</a>
Coupon Report	730	F1h DAh	New Coupon Format	<a href="#">169</a>
ISSN EAN	617	F1h 69h	Disable	<a href="#">170</a>
<b>Code 128</b>				
Code 128	8	08h	Enable	<a href="#">171</a>
Set Length(s) for Code 128	209, 210	D1h, D2h	1 to 55	<a href="#">172</a>
GS1-128 (formerly UCC/EAN-128)	14	0Eh	Enable	<a href="#">174</a>
ISBT 128	84	54h	Enable	<a href="#">174</a>
ISBT Concatenation	577	F1h 41h	Autodiscriminate	<a href="#">175</a>
Check ISBT Table	578	F1h 42h	Enable	<a href="#">176</a>
ISBT Concatenation Redundancy	223	DFh	10	<a href="#">176</a>
Code 128 Security Level	751	F1h EFh	Security Level 1	<a href="#">177</a>
Code 128 Reduced Quiet Zone	1208	F8h 04h B8h	Disable	<a href="#">178</a>
Ignore Code 128 <FNC4>	1254	F8h 04h E6h	Disable	<a href="#">178</a>
Code 128 Exclusive	Param 673	SSI F1h A1H	Disable	<a href="#">179</a>
<b>Code 39</b>				
Code 39	0	00h	Enable	<a href="#">180</a>
Trioptic Code 39	13	0Dh	Disable	<a href="#">180</a>
Convert Code 39 to Code 32 (Italian Pharmacy Code)	86	56h	Disable	<a href="#">181</a>
Code 32 Prefix	231	E7h	Disable	<a href="#">182</a>
Set Length(s) for Code 39	18, 19	12h, 13h	1 to 55	<a href="#">183</a>
Code 39 Check Digit Verification	48	30h	Disable	<a href="#">184</a>
Transmit Code 39 Check Digit	43	2Bh	Disable	<a href="#">184</a>
Code 39 Full ASCII Conversion	17	11h	Disable	<a href="#">185</a>
Code 39 Security Level	750	F1h EEh	Security Level 1	<a href="#">186</a>
Code 39 Reduced Quiet Zone	1209	F8h 04h B9h	Disable	<a href="#">187</a>
Code 39 Buffering - Scan and Store	113	71h	Disable	<a href="#">187</a>

**Table 8** Symbology Parameter Defaults (Continued)

Parameter	Parameter Number	SSI Number	Default	Page Number
<b>Code 93</b>				
Code 93	9	09h	Enable	<a href="#">190</a>
Set Length(s) for Code 93	26, 27	1Ah, 1Bh	1 to 55	<a href="#">190</a>
<b>Code 11</b>				
Code 11	10	0Ah	Disable	<a href="#">192</a>
Set Lengths for Code 11	28, 29	1Ch, 1Dh	4 to 55	<a href="#">192</a>
Code 11 Check Digit Verification	52	34h	Disable	<a href="#">194</a>
Transmit Code 11 Check Digit(s)	47	2Fh	Disable	<a href="#">195</a>
<b>Interleaved 2 of 5 (ITF)</b>				
Interleaved 2 of 5 (ITF)	6	06h	Disable	<a href="#">196</a>
Set Lengths for I 2 of 5	22, 23	16h, 17h	6 to 55	<a href="#">197</a>
I 2 of 5 Check Digit Verification	49	31h	Disable	<a href="#">199</a>
Transmit I 2 of 5 Check Digit	44	2Ch	Disable	<a href="#">200</a>
Convert I 2 of 5 to EAN 13	82	52h	Disable	<a href="#">200</a>
I 2 of 5 Security Level	1121	F8h 04h 61h	Security Level 1	<a href="#">201</a>
I 2 of 5 Reduced Quiet Zone	1210	F8h 04h BAh	Disable	<a href="#">202</a>
<b>Discrete 2 of 5 (DTF)</b>				
Discrete 2 of 5	5	05h	Disable	<a href="#">203</a>
Set Length(s) for D 2 of 5	20, 21	14h 15h	1 to 55	<a href="#">204</a>
<b>Codabar (NW - 7)</b>				
Codabar	7	07h	Enable	<a href="#">206</a>
Set Lengths for Codabar	24, 25	18h, 19h	4 to 55	<a href="#">206</a>
CLSI Editing	54	36h	Disable	<a href="#">208</a>
NOTIS Editing	55	37h	Disable	<a href="#">208</a>
Codabar Upper or Lower Case Start/ Stop Characters Detection	855	F2h 57h	Upper Case	<a href="#">209</a>
Codabar Mod 16 Check Digit Verification	1784	F8h 06h F8h	Disable	<a href="#">209</a>
<b>MSI</b>				
MSI	11	0Bh	Disable	<a href="#">210</a>
Set Length(s) for MSI	30, 31	1Eh, 1Fh	4 to 55	<a href="#">210</a>
MSI Check Digits	50	32h	One	<a href="#">212</a>

**Table 8** Symbology Parameter Defaults (Continued)

Parameter	Parameter Number	SSI Number	Default	Page Number
Transmit MSI Check Digit	46	2Eh	Disable	<a href="#">212</a>
MSI Check Digit Algorithm	51	33h	Mod 10/Mod 10	<a href="#">214</a>
<b>Chinese 2 of 5</b>				
Chinese 2 of 5	408	F0h 98h	Disable	<a href="#">215</a>
<b>Matrix 2 of 5</b>				
Matrix 2 of 5	618	F1h 6Ah	Disable	<a href="#">216</a>
Matrix 2 of 5 Lengths	619 620	F1h 6Bh F1h 6Ch	4 to 55	<a href="#">216</a>
Matrix 2 of 5 Check Digit	622	F1h 6Eh	Disable	<a href="#">218</a>
Transmit Matrix 2 of 5 Check Digit	623	F1h 6Fh	Disable	<a href="#">218</a>
<b>Korean 3 of 5</b>				
Korean 3 of 5	581	F1h 45h	Disable	<a href="#">219</a>
Inverse 1D	586	F1h 4Ah	Regular	<a href="#">220</a>
<b>GS1 DataBar</b>				
GS1 DataBar-14	338	F0h 52h	Enable	<a href="#">221</a>
GS1 DataBar Limited	339	F0h 53h	Enable	<a href="#">221</a>
GS1 DataBar Expanded	340	F0h 54h	Enable	<a href="#">222</a>
Convert GS1 DataBar to UPC/EAN	397	F0h 8Dh	Disable	<a href="#">222</a>
GS1 DataBar Limited Security Level	728	F1h D8h	Level 3	<a href="#">223</a>
<b>Composite</b>				
Composite CC-C	341	F0h 55h	Disable	<a href="#">224</a>
Composite CC-A/B	342	F0h 56h	Disable	<a href="#">224</a>
Composite TLC-39	371	F0h 73h	Disable	<a href="#">225</a>
UPC Composite Mode	344	F0h 58h	UPC Never Linked	<a href="#">226</a>
Composite Beep Mode	398	F0h 8Eh	Beep As Each Code Type is Decoded	<a href="#">227</a>
GS1-128 Emulation Mode for UCC/EAN Composite Codes	427	F0h ABh	Disable	<a href="#">227</a>
<b>2D Symbologies</b>				
PDF417	15	0Fh	Enable	<a href="#">228</a>
MicroPDF417	227	E3h	Disable	<a href="#">228</a>
Code 128 Emulation	123	7Bh	Disable	<a href="#">229</a>

**Table 8** Symbology Parameter Defaults (Continued)

Parameter	Parameter Number	SSI Number	Default	Page Number
Data Matrix	292	F0h 24h	Enable	<a href="#">230</a>
GS1 Data Matrix	1336	F8h 05h 38h	Disable	<a href="#">230</a>
Data Matrix Inverse	588	F1h 4Ch	Inverse Autodetect	<a href="#">231</a>
Maxicode	294	F0h 26h	Disable	<a href="#">231</a>
QR Code	293	F0h 25h	Enable	<a href="#">232</a>
GS1 QR	1343	F8h 05h 3Fh	Disable	<a href="#">232</a>
MicroQR	573	F1h 3Dh	Enable	<a href="#">233</a>
Aztec	574	F1h 3Eh	Enable	<a href="#">233</a>
Aztec Inverse	589	F1h 4Dh	Inverse Autodetect	<a href="#">233</a>
Han Xin	1167	F8h 04h 8Fh	Disable	<a href="#">234</a>
Han Xin Inverse	1168	F8h 04h 90h	Regular	<a href="#">234</a>
DotCode	1906	F8 07 72h	Disable	<a href="#">236</a>
DotCode Inverse	1907	F8 07 73h	Autodetect	<a href="#">237</a>
DotCode Mirrored	1908	F8 07 74h	Autodetect	<a href="#">238</a>
DotCode Prioritize	1937	F8 07 91h	Disable	<a href="#">239</a>
<b>Postal Codes</b>				
US Postnet	89	59h	Disable	<a href="#">240</a>
US Planet	90	5Ah	Disable	<a href="#">240</a>
Transmit US Postal Check Digit	95	5Fh	Enable	<a href="#">241</a>
UK Postal	91	5Bh	Disable	<a href="#">241</a>
Transmit UK Postal Check Digit	96	60h	Enable	<a href="#">242</a>
Japan Postal	290	F0h 22h	Disable	<a href="#">242</a>
Australia Post	291	F0h 23h	Disable	<a href="#">243</a>
Australia Post Format	718	F1h CEh	Autodiscriminate	<a href="#">244</a>
Netherlands KIX Code	326	F0h 46h	Disable	<a href="#">245</a>
USPS 4CB/One Code/Intelligent Mail	592	F1h 50h	Disable	<a href="#">245</a>
UPU FICS Postal	611	F1h 63h	Disable	<a href="#">246</a>
Mailmark	1337	F8h 05h 39h	Disable	<a href="#">246</a>
Canada Post	92	5Ch	Disable	<a href="#">247</a>
Digimarc Barcode	N/A	N/A	Disable	<a href="#">254</a>

**Table 8** Symbology Parameter Defaults (Continued)

Parameter	Parameter Number	SSI Number	Default	Page Number
Posti LAPA 4-State Code	2031	F8 07EF	Disable	<a href="#">247</a>
<b>Symbology-Specific Security Levels</b>				
Redundancy Level	78	4Eh	1	<a href="#">248</a>
Security Level	77	4Dh	1	<a href="#">250</a>
1D Quiet Zone Level	1288	F8h 05h 08h	1	<a href="#">251</a>
Intercharacter Gap Size	381	F0h 7Dh	Normal	<a href="#">252</a>
Report Version				<a href="#">252</a>
<b>Macro PDF</b>				
Flush Macro PDF Buffer	N/A	N/A	N/A	<a href="#">253</a>
Abort Macro PDF Entry	N/A	N/A	N/A	<a href="#">253</a>

---

## Enable/Disable All Code Types

To disable all symbologies, scan **Disable All Code Types** below. This is useful when enabling only a few code types.

Scan **Enable All Code Types** turn on (enable) all code types. This is useful when you want to read all codes, or when you want to disable only a few code types.



**Disable All Code Types**



**Enable All Code Types**

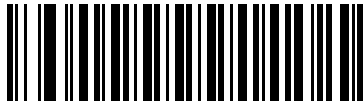


## UPC/EAN

### Enable/Disable UPC-A

#### Parameter # 1 (SSI # 01h)

To enable or disable UPC-A, scan the appropriate barcode below.



**\*Enable UPC-A  
(1)**

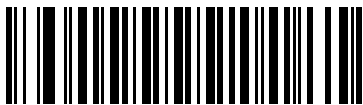


**Disable UPC-A  
(0)**

### Enable/Disable UPC-E

#### Parameter # 2 (SSI # 02h)

To enable or disable UPC-E, scan the appropriate barcode below.



**\*Enable UPC-E  
(1)**



**Disable UPC-E  
(0)**

## Enable/Disable UPC-E1

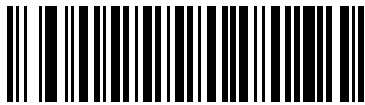
### Parameter # 12 (SSI # 0Ch)

UPC-E1 is disabled by default.

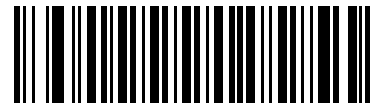
To enable or disable UPC-E1, scan the appropriate barcode below.



**NOTE:** UPC-E1 is not a UCC (Uniform Code Council) approved symbology.



**Enable UPC-E1  
(1)**



**\*Disable UPC-E1  
(0)**

## Enable/Disable EAN-8/JAN-8

### Parameter # 4 (SSI # 04h)

To enable or disable EAN-8/JAN-8, scan the appropriate barcode below.



**\*Enable EAN-8/JAN-8  
(1)**

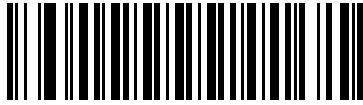


**Disable EAN-8/JAN-8  
(0)**

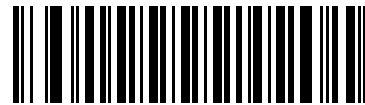
## Enable/Disable EAN-13/JAN-13

### Parameter # 3 (SSI # 03h)

To enable or disable EAN-13/JAN-13, scan the appropriate barcode below.



**\*Enable EAN-13/JAN-13  
(1)**

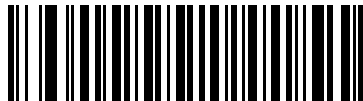


**Disable EAN-13/JAN-13  
(0)**

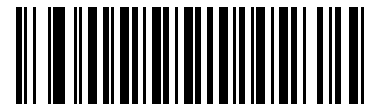
## Enable/Disable Bookland EAN

### Parameter # 83 (SSI # 53h)

To enable or disable Bookland EAN, scan the appropriate barcode below.



**Enable Bookland EAN  
(1)**



**\*Disable Bookland EAN  
(0)**



**NOTE:** If you enable Bookland EAN, select a [Bookland ISBN Format on page 167](#). Also select either Decode UPC/EAN Supplementals, Autodiscriminate UPC/EAN Supplementals, or Enable 978/979 Supplemental Mode in [Decode UPC/EAN/JAN Supplementals on page 155](#).

## Decode UPC/EAN/JAN Supplementals

### Parameter # 16 (SSI # 10h)

Supplementals are barcodes appended according to specific format conventions (e.g., UPC A+2, UPC E+2, EAN 13+2). The following options are available:

- If you select **Ignore UPC/EAN with Supplementals**, and the RS5100 is presented with a UPC/EAN plus supplemental symbol, the RS5100 decodes UPC/EAN and ignores the supplemental characters.
- If you select **Decode UPC/EAN with Supplementals**, the RS5100 only decodes UPC/EAN symbols with supplemental characters, and ignores symbols without supplementals.
- If you select **Autodiscriminate UPC/EAN Supplementals**, the RS5100 decodes UPC/EAN symbols with supplemental characters immediately. If the symbol does not have a supplemental, the RS5100 must decode the barcode the number of times set via [UPC/EAN/JAN Supplemental Redundancy on page 158](#) before transmitting its data to confirm that there is no supplemental.
- If you select one of the following **Supplemental Mode** options, the RS5100 immediately transmits EAN-13 barcodes starting with that prefix that have supplemental characters. If the symbol does not have a supplemental, the RS5100 must decode the barcode the number of times set via [UPC/EAN/JAN Supplemental Redundancy on page 158](#) before transmitting its data to confirm that there is no supplemental. The RS5100 transmits UPC/EAN barcodes that do not have that prefix immediately.
  - Enable 378/379 Supplemental Mode
  - Enable 978/979 Supplemental Mode



**NOTE:** If you select 978/979 Supplemental Mode and are scanning Bookland EAN barcodes, see [Enable/Disable Bookland EAN on page 154](#) to enable Bookland EAN, and select a format using [Bookland ISBN Format on page 167](#).

- Enable 977 Supplemental Mode
- Enable 414/419/434/439 Supplemental Mode
- Enable 491 Supplemental Mode
- **Enable Smart Supplemental Mode** - applies to EAN-13 barcodes starting with any prefix listed previously.
- **Supplemental User-Programmable Type 1** - applies to EAN-13 barcodes starting with a 3-digit user-defined prefix. Set this 3-digit prefix using [User-Programmable Supplementals on page 158](#).
- **Supplemental User-Programmable Type 1 and 2** - applies to EAN-13 barcodes starting with either of two 3-digit user-defined prefixes. Set the 3-digit prefixes using [User-Programmable Supplementals on page 158](#).
- **Smart Supplemental Plus User-Programmable 1** - applies to EAN-13 barcodes starting with any prefix listed previously or the user-defined prefix set using [User-Programmable Supplementals on page 158](#).
- **Smart Supplemental Plus User-Programmable 1 and 2** - applies to EAN-13 barcodes starting with any prefix listed previously or one of the two user-defined prefixes set using [User-Programmable Supplementals on page 158](#)

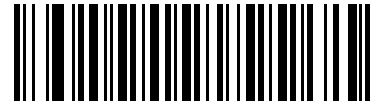


**NOTE:** To minimize the risk of invalid data transmission, select either to decode or ignore supplemental characters.

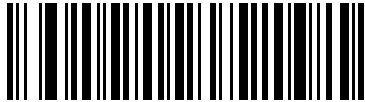
## Decode UPC/EAN/JAN Supplementals (continued)



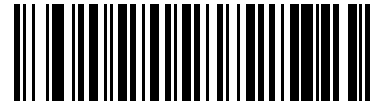
Decode UPC/EAN/JAN Only With Supplementals  
(1)



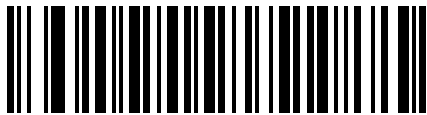
\*Ignore Supplementals  
(0)



Autodiscriminate UPC/EAN/JAN Supplementals  
(2)



Enable 378/379 Supplemental Mode  
(4)

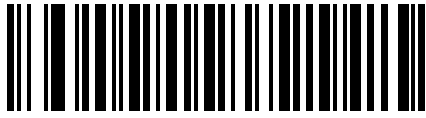


Enable 978/979 Supplemental Mode  
(5)



Enable 977 Supplemental Mode  
(7)

## Decode UPC/EAN/JAN Supplementals (continued)



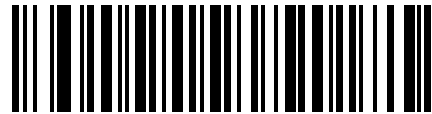
Enable 414/419/434/439 Supplemental Mode  
(6)



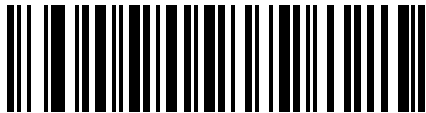
Enable 491 Supplemental Mode  
(8)



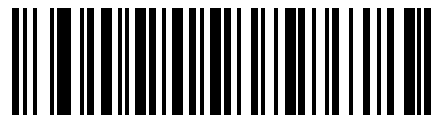
Enable Smart Supplemental Mode  
(3)



Supplemental User-Programmable Type 1  
(9)



Supplemental User-Programmable Type 1 and 2  
(10)



Smart Supplemental Plus User-Programmable 1  
(11)



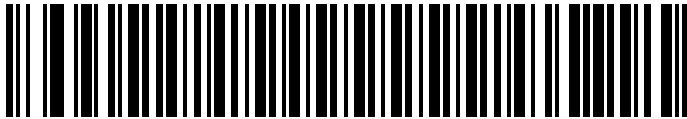
Smart Supplemental Plus User-Programmable 1  
and 2  
(12)

## User-Programmable Supplementals

### Supplemental 1: Parameter # 579 (SSI # F1h 43h)

### Supplemental 2: Parameter # 580 (SSI # F1h 44h)

If you selected a Supplemental User-Programmable option from [Decode UPC/EAN/JAN Supplementals on page 155](#), select **User-Programmable Supplemental 1** to set the 3-digit prefix. Then select the 3 digits using the numeric barcodes beginning on page [324](#). Select **User-Programmable Supplemental 2** to set a second 3-digit prefix. Then select the 3 digits using the numeric barcodes beginning on page [324](#). The default is 000 (zeroes).



User-Programmable Supplemental 1



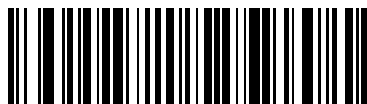
User-Programmable Supplemental 2

## UPC/EAN/JAN Supplemental Redundancy

### Parameter # 80 (SSI # 50h)

If you selected **Autodiscriminate UPC/EAN/JAN Supplementals**, this option adjusts the number of times to decode a symbol without supplementals before transmission. The range is from two to thirty times. Five or above is recommended when decoding a mix of UPC/EAN/JAN symbols with and without supplementals. The default is 10.

Scan the barcode below to set a decode redundancy value. Next, scan two numeric barcodes in [Alphanumeric and Numeric Barcodes](#). Enter a leading zero for single digit numbers. To correct an error or change a selection, scan [Cancel on page 325](#).



UPC/EAN/JAN Supplemental Redundancy

## UPC/EAN/JAN Supplemental AIM ID Format

### Parameter # 672 (SSI # F1h A0h)

Select an output format when reporting UPC/EAN/JAN barcodes with Supplementals with [Transmit Code ID Character](#) on page 136 set to **AIM Code ID Character**:

- **Separate** - transmit UPC/EAN with supplementals with separate AIM IDs but one transmission, i.e.:  
]E<0 or 4><data>]E<1 or 2>[supplemental data]
- **Combined** – transmit UPC/EAN with supplementals with one AIM ID and one transmission, i.e.:  
]E3<data+supplemental data>
- **Separate Transmissions** - transmit UPC/EAN with supplementals with separate AIM IDs and separate transmissions, i.e.:

]E<0 or 4><data>  
]E<1 or 2>[supplemental data]



Separate  
(0)



\*Combined  
(1)



Separate Transmissions  
(2)



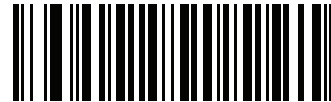
## UPC Reduced Quiet Zone

### Parameter # 1289 (SSI # F8h 05h 09h)

Scan one of the following barcodes to enable or disable decoding UPC barcodes with reduced quiet zones. If you select **Enable**, select a [1D Quiet Zone Level on page 251](#).



**Enable UPC Reduced Quiet Zone  
(1)**



**\*Disable UPC Reduced Quiet Zone  
(0)**

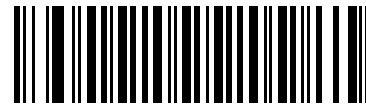
## Transmit UPC-A Check Digit

### Parameter # 40 (SSI # 28h)

The check digit is the last character of the symbol used to verify the integrity of the data. Scan the appropriate barcode below to transmit the barcode data with or without the UPC-A check digit. It is always verified to guarantee the integrity of the data.



**\*Transmit UPC-A Check Digit  
(1)**

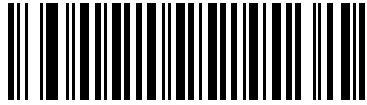


**Do Not Transmit UPC-A Check Digit  
(0)**

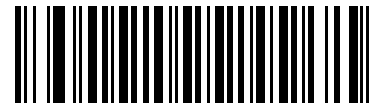
## Transmit UPC-E Check Digit

### Parameter # 41 (SSI # 29h)

The check digit is the last character of the symbol used to verify the integrity of the data. Scan the appropriate barcode below to transmit the barcode data with or without the UPC-E check digit. It is always verified to guarantee the integrity of the data.



**\*Transmit UPC-E Check Digit  
(1)**

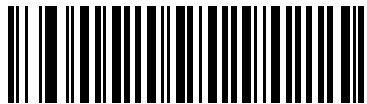


**Do Not Transmit UPC-E Check Digit  
(0)**

## Transmit UPC-E1 Check Digit

### Parameter # 42 (SSI # 2Ah)

The check digit is the last character of the symbol used to verify the integrity of the data. Scan the appropriate barcode below to transmit the barcode data with or without the UPC-E1 check digit. It is always verified to guarantee the integrity of the data.



**\*Transmit UPC-E1 Check Digit  
(1)**

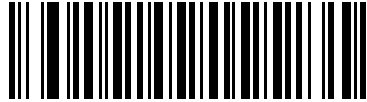


**Do Not Transmit UPC-E1 Check Digit  
(0)**

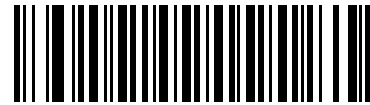
## UPC-A Preamble

### Parameter # 34 (SSI # 22h)

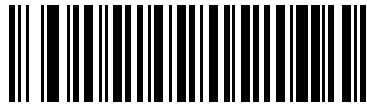
Preamble characters are part of the UPC symbol, and include Country Code and System Character. There are three options for transmitting a UPC-A preamble to the host device: transmit System Character only, transmit System Character and Country Code ("0" for USA), and transmit no preamble. Select the appropriate option to match the host system.



No Preamble (<DATA>)  
(0)



\*System Character (<SYSTEM CHARACTER>  
<DATA>)  
(1)

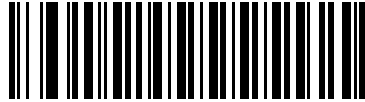


System Character & Country Code  
(< COUNTRY CODE> <SYSTEM CHARACTER>  
<DATA>)  
(2)

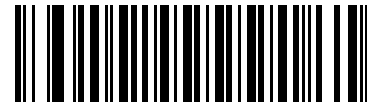
## UPC-E Preamble

### Parameter # 35 (SSI # 23h)

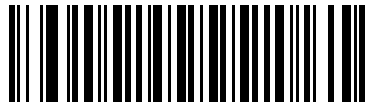
Preamble characters are part of the UPC symbol, and include Country Code and System Character. There are three options for transmitting a UPC-E preamble to the host device: transmit System Character only, transmit System Character and Country Code ("0" for USA), and transmit no preamble. Select the appropriate option to match the host system.



No Preamble (<DATA>  
(0)



\*System Character (<SYSTEM CHARACTER>  
<DATA>  
(1)

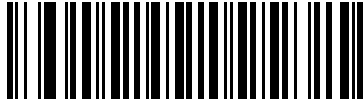


System Character & Country Code  
(< COUNTRY CODE> <SYSTEM CHARACTER>  
<DATA>  
(2)

## UPC-E1 Preamble

### Parameter # 36 (SSI # 24h)

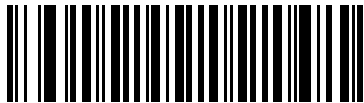
Preamble characters are part of the UPC symbol, and include Country Code and System Character. There are three options for transmitting a UPC-E1 preamble to the host device: transmit System Character only, transmit System Character and Country Code ("0" for USA), and transmit no preamble. Select the appropriate option to match the host system.



No Preamble (<DATA>)  
(0)



\*System Character (<SYSTEM CHARACTER> <DATA>)  
(1)



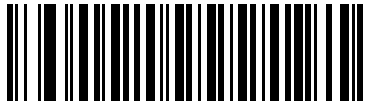
System Character & Country Code  
(< COUNTRY CODE> <SYSTEM CHARACTER> <DATA>)  
(2)

## Convert UPC-E to UPC-A

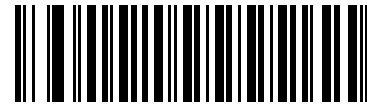
### Parameter # 37 (SSI # 25h)

Enable this to convert UPC-E (zero suppressed) decoded data to UPC-A format before transmission. After conversion, the data follows UPC-A format and is affected by UPC-A programming selections (e.g., Preamble, Check Digit).

Disable this to transmit UPC-E decoded data as UPC-E data, without conversion.



Convert UPC-E to UPC-A (Enable)  
(1)



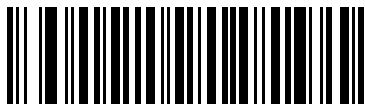
\*Do Not Convert UPC-E to UPC-A (Disable)  
(0)

## Convert UPC-E1 to UPC-A

### Parameter # 38 (SSI # 26h)

Enable this to convert UPC-E1 decoded data to UPC-A format before transmission. After conversion, the data follows UPC-A format and is affected by UPC-A programming selections (e.g., Preamble, Check Digit).

Disable this to transmit UPC-E1 decoded data as UPC-E1 data, without conversion.



Convert UPC-E1 to UPC-A (Enable)  
(1)



\*Do Not Convert UPC-E1 to UPC-A (Disable)  
(0)

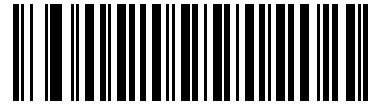
## EAN-8/JAN-8 Extend

### Parameter # 39 (SSI # 27h)

Enable this parameter to add five leading zeros to decoded EAN-8 symbols to make them compatible in format to EAN-13 symbols. Disable this to transmit EAN-8 symbols as is.



**Enable EAN/JAN Zero Extend  
(1)**



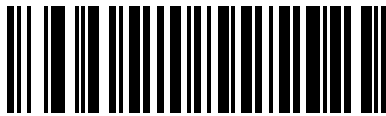
**\*Disable EAN/JAN Zero Extend  
(0)**

## Bookland ISBN Format

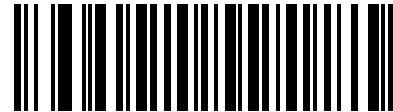
### Parameter # 576 (SSI # F1h 40h)

If you enabled Bookland EAN using [Enable/Disable Bookland EAN on page 154](#), select one of the following formats for Bookland data:

- **Bookland ISBN-10** - The RS5100 reports Bookland data starting with 978 in traditional 10-digit format with the special Bookland check digit for backward-compatibility. Data starting with 979 is not considered Bookland in this mode.
- **Bookland ISBN-13** - The RS5100 reports Bookland data (starting with either 978 or 979) as EAN-13 in 13-digit format to meet the 2007 ISBN-13 protocol.



\*Bookland ISBN-10  
(0)



Bookland ISBN-13  
(1)



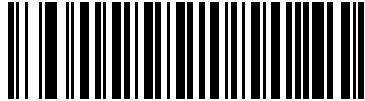
**NOTE:** For Bookland EAN to function properly, first enable Bookland EAN using [Enable/Disable Bookland EAN on page 154](#), then select either Decode UPC/EAN Supplementals, Autodiscriminate UPC/EAN Supplementals, or Enable 978/979 Supplemental Mode in [Decode UPC/EAN/JAN Supplementals on page 155](#).



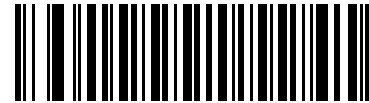
## UCC Coupon Extended Code

### Parameter # 85 (SSI # 55h)

Enable this parameter to decode UPC-A barcodes starting with digit '5', EAN-13 barcodes starting with digit '99', and UPC-A/GS1-128 Coupon Codes. UPCA, EAN-13, and GS1-128 must be enabled to scan all types of Coupon Codes.



**Enable UCC Coupon Extended Code**  
(1)



**\*Disable UCC Coupon Extended Code**  
(0)



**NOTE:** See [UPC/EAN/JAN Supplemental Redundancy on page 158](#) to control autodiscrimination of the GS1-128 (right half) of a coupon code.

## Coupon Report

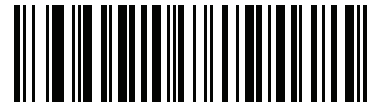
### Parameter # 730 (SSI # F1h DAh)

Select an option to determine which type of coupon format to support.

- Select **Old Coupon Format** to support UPC-A/GS1-128 and EAN-13/GS1-128.
- Select **New Coupon Format** as an interim format to support UPC-A/GS1-DataBar and EAN-13/GS1-DataBar.
- If you select **Autodiscriminate Format**, the RS5100 supports both **Old Coupon Format** and **New Coupon Format**.



**Old Coupon Format**  
(0)



**\*New Coupon Format**  
(1)



**Autodiscriminate Coupon Format**  
(2)

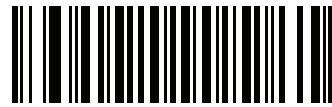
## ISSN EAN

### Parameter # 617 (SSI # F1h 69h)

To enable or disable ISSN EAN, scan the appropriate barcode below.



**Enable ISSN EAN**  
**(1)**



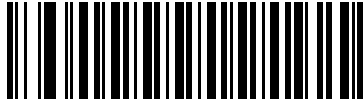
**\*Disable ISSN EAN**  
**(0)**

## Code 128

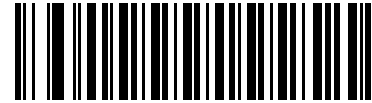
### Enable/Disable Code 128

#### Parameter # 8 (SSI # 08h)

To enable or disable Code 128, scan the appropriate barcode below.



**\*Enable Code 128  
(1)**



**Disable Code 128  
(0)**

## Set Lengths for Code 128

### Parameter # L1 = 209 (SSI # D1h), L2 = 210 (SSI # D2h)

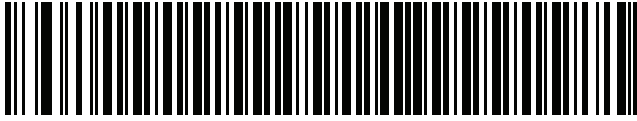
The length of a code refers to the number of characters (i.e., human readable characters), including check digit(s) the code contains. Set lengths for Code 128 to any length, one or two discrete lengths, or lengths within a specific range. The default is 1 to 55.



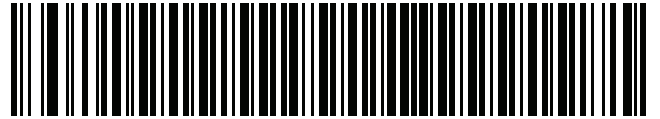
**NOTE:** When setting lengths for different barcode types, enter a leading zero for single digit numbers.

- **One Discrete Length** - Select this option to decode only Code 128 symbols containing a selected length. Select the length using the numeric barcodes in [Alphanumeric and Numeric Barcodes](#). For example, to decode only Code 128 symbols with 14 characters, scan **Code 128 - One Discrete Length**, then scan **1** followed by **4**. To correct an error or change the selection, scan [Cancel on page 325](#).
- **Two Discrete Lengths** - Select this option to decode only Code 128 symbols containing either of two selected lengths. Select lengths using the numeric barcodes in [Alphanumeric and Numeric Barcodes](#). For example, to decode only Code 128 symbols containing either 2 or 14 characters, select **Code 128 - Two Discrete Lengths**, then scan **0, 2, 1**, and then **4**. To correct an error or change the selection, scan [Cancel on page 325](#).
- **Length Within Range** - Select this option to decode a Code 128 symbol with a specific length range. Select lengths using numeric barcodes in [Alphanumeric and Numeric Barcodes](#). For example, to decode Code 128 symbols containing between 4 and 12 characters, first scan **Code 128 - Length Within Range**. Then scan **0, 4, 1**, and **2** (enter a leading zero for single digit numbers). To correct an error or change the selection, scan [Cancel on page 325](#).
- **Any Length** - Select this option to decode Code 128 symbols containing any number of characters within the RS5100's capability.

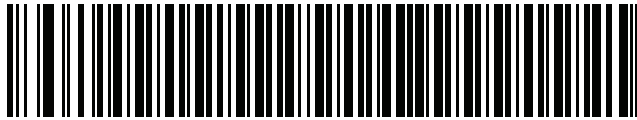
### Set Lengths for Code 128 (continued)



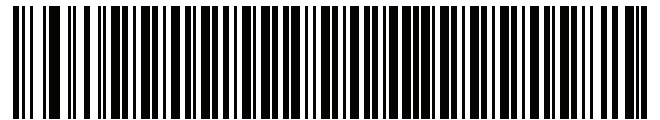
Code 128 - One Discrete Length



Code 128 - Two Discrete Lengths



Code 128 - Length Within Range

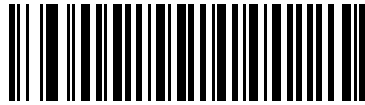


Code 128 - Any Length

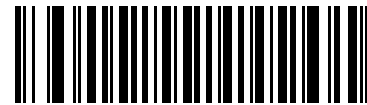
## Enable/Disable GS1-128 (formerly UCC/EAN-128)

### Parameter # 14 (SSI # 0Eh)

To enable or disable GS1-128, scan the appropriate barcode below.



**\*Enable GS1-128  
(1)**



**Disable GS1-128  
(0)**

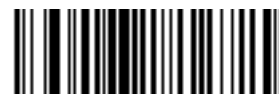
## Enable/Disable ISBT 128

### Parameter # 84 (SSI # 54h)

ISBT 128 is a variant of Code 128 used in the blood bank industry. Scan a barcode below to enable or disable ISBT 128. If necessary, the host must perform concatenation of the ISBT data.



**\*Enable ISBT 128  
(1)**



**Disable ISBT 128  
(0)**

## ISBT Concatenation

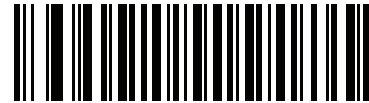
### Parameter # 577 (SSI # F1h 41h)

Select an option for concatenating pairs of ISBT code types:

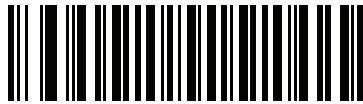
- If you select **Disable ISBT Concatenation**, the RS5100 does not concatenate pairs of ISBT codes it encounters.
- If you select **Enable ISBT Concatenation**, there must be two ISBT codes in order for the RS5100 to decode and perform concatenation. The RS5100 does not decode single ISBT symbols.
- If you select **Autodiscriminate ISBT Concatenation**, the RS5100 decodes and concatenates pairs of ISBT codes immediately. If only a single ISBT symbol is present, the RS5100 must decode the symbol the number of times set via [ISBT Concatenation Redundancy on page 176](#) before transmitting its data to confirm that there is no additional ISBT symbol.



**Disable ISBT Concatenation  
(0)**



**Enable ISBT Concatenation  
(1)**



**\*Autodiscriminate ISBT Concatenation  
(2)**



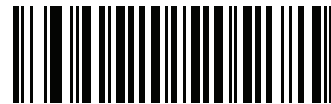
## Check ISBT Table

### Parameter # 578 (SSI # F1h 42h)

The ISBT specification includes a table that lists several types of ISBT barcodes that are commonly used in pairs. If you set **ISBT Concatenation** to **Enable**, enable **Check ISBT Table** to concatenate only those pairs found in this table. Other types of ISBT codes are not concatenated.



\*Enable Check ISBT Table  
(1)



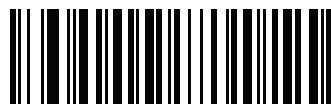
Disable Check ISBT Table  
(0)

## ISBT Concatenation Redundancy

### Parameter # 223 (SSI # DFh)

If you set **ISBT Concatenation** to **Autodiscriminate**, use this parameter to set the number of times the RS5100 must decode an ISBT symbol before determining that there is no additional symbol.

Scan the barcode below, then scan two numeric barcodes in [Alphanumeric and Numeric Barcodes](#) to set a value between 2 and 20. Enter a leading zero for single digit numbers. To correct an error or change a selection, scan [Cancel on page 325](#). The default is 10.



ISBT Concatenation Redundancy

## Code 128 Security Level

### Parameter # 751 (SSI # F1h EFh)

Code 128 barcodes are vulnerable to misdecodes, particularly when Code 128 Lengths is set to **Any Length**. The RS5100 offers four levels of decode security for Code 128 barcodes. There is an inverse relationship between security and RS5100 aggressiveness. Increasing the level of security can reduce scanning aggressiveness, so select only the level of security necessary.

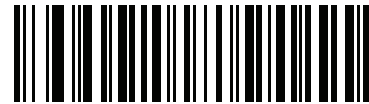
- **Code 128 Security Level 0:** This setting allows the RS5100 to operate in its most aggressive state, while providing sufficient security in decoding most in-spec barcodes.
- **Code 128 Security Level 1:** A barcode must be successfully read twice, and satisfy certain safety requirements before being decoded. This default setting eliminates most misdecodes.
- **Code 128 Security Level 2:** Select this option with greater barcode security requirements if **Security Level 1** fails to eliminate misdecodes.
- **Code 128 Security Level 3:** If you selected **Security Level 2**, and misdecodes still occur, select this security level to apply the highest safety requirements. A barcode must be successfully read three times before being decoded.



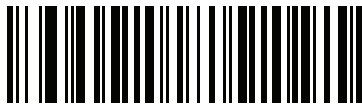
**NOTE:** Selecting this option is an extreme measure against mis-decoding severely out-of-spec barcodes. Selecting this level of security significantly impairs the decoding ability of the RS5100. If this level of security is required, try to improve the quality of the barcodes.



Code 128 Security Level 0  
(0)



\*Code 128 Security Level 1  
(1)



Code 128 Security Level 2  
(2)



Code 128 Security Level 3  
(3)

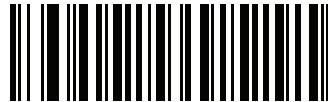
## Code 128 Reduced Quiet Zone

### Parameter # 1208 (SSI # F8h 04h B8h)

Scan one of the following barcodes to enable or disable decoding Code 128 barcodes with reduced quiet zones. If you select **Enable**, select a [1D Quiet Zone Level on page 251](#).



Enable Code 128 Reduced Quiet Zone  
(1)



\*Disable Code 128 Reduced Quiet Zone  
(0)

## Ignore Code 128 <FNC4>

### Parameter # 1254 (SSI # F8h 04h E6h)

This feature applies to Code 128 barcodes with an embedded <FNC4> character. Enable this to strip the <FNC4> character from the decode data. The remaining characters are sent to the host unchanged. When disabled, the <FNC4> character is processed normally as per Code 128 standard.



Enable Ignore Code 128 <FNC4>  
(1)

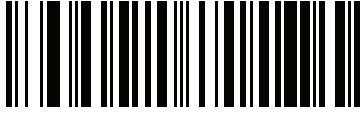


\*Disable Ignore Code 128 <FNC4>  
(0)

## Code 128 Exclusive

### Parameter # 673 (SSI # SSI F1h A1h)

This feature only allows decoding of barcode matching the Code 128 Exclusive format.



**Enable**  
**(1)**



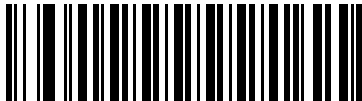
**\*Disable**  
**(0)**

## Code 39

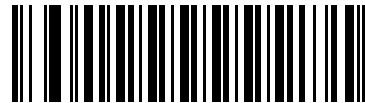
### Enable/Disable Code 39

#### Parameter # 0 (SSI # 00h)

To enable or disable Code 39, scan the appropriate barcode below.



**\*Enable Code 39**  
(1)

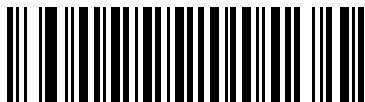


**Disable Code 39**  
(0)

### Enable/Disable Trioptic Code 39

#### Parameter # 13 (SSI # 0Dh)

Trioptic Code 39 is a variant of Code 39 used in the marking of computer tape cartridges. Trioptic Code 39 symbols always contain six characters. To enable or disable Trioptic Code 39, scan the appropriate barcode below.



**Enable Trioptic Code 39**  
(1)



**\*Disable Trioptic Code 39**  
(0)



**NOTE:** You cannot enable Trioptic Code 39 and Code 39 Full ASCII simultaneously.

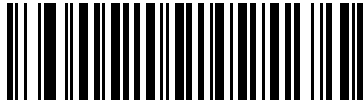
## Convert Code 39 to Code 32

### Parameter # 86 (SSI # 56h)

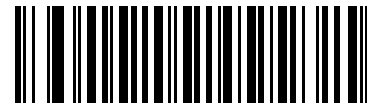
Code 32 is a variant of Code 39 used by the Italian pharmaceutical industry. Scan the appropriate barcode below to enable or disable converting Code 39 to Code 32.



**NOTE:** Code 39 must be enabled for this parameter to function.



**Enable Convert Code 39 to Code 32**  
(1)



**\*Disable Convert Code 39 to Code 32**  
(0)

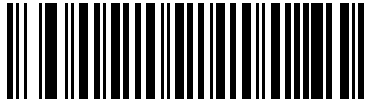
## Code 32 Prefix

### Parameter # 231 (SSI # E7h)

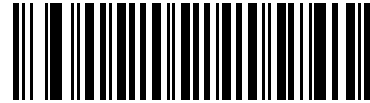
Scan the appropriate barcode below to enable or disable adding the prefix character “A” to all Code 32 barcodes.



**NOTE:** Convert Code 39 to Code 32 must be enabled for this parameter to function.



**Enable Code 32 Prefix  
(1)**



**\*Disable Code 32 Prefix  
(0)**

## Set Lengths for Code 39

### Parameter # L1 = 18 (SSI # 12h), L2 = 19 (SSI # 13h)

The length of a code refers to the number of characters (i.e., human readable characters), including check digit(s) the code contains. Set lengths for Code 39 to any length, one or two discrete lengths, or lengths within a specific range. If Code 39 Full ASCII is enabled, **Length Within a Range** or **Any Length** are the preferred options. The default is 1 to 55.

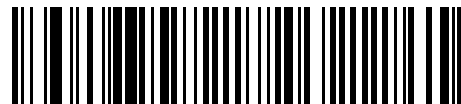


**NOTE:** When setting lengths for different barcode types, enter a leading zero for single digit numbers.

- **One Discrete Length** - Select this option to decode only Code 39 symbols containing a selected length. Select the length using the numeric barcodes in [Alphanumeric and Numeric Barcodes](#). For example, to decode only Code 39 symbols with 14 characters, scan **Code 39 - One Discrete Length**, then scan **1** followed by **4**. To correct an error or change the selection, scan [Cancel on page 325](#).
- **Two Discrete Lengths** - Select this option to decode only Code 39 symbols containing either of two selected lengths. Select lengths using the numeric barcodes in [Alphanumeric and Numeric Barcodes](#). For example, to decode only Code 39 symbols containing either 2 or 14 characters, select **Code 39 - Two Discrete Lengths**, then scan **0, 2, 1**, and then **4**. To correct an error or change the selection, scan [Cancel on page 325](#).
- **Length Within Range** - Select this option to decode a Code 39 symbol with a specific length range. Select lengths using numeric barcodes in [Alphanumeric and Numeric Barcodes](#). For example, to decode Code 39 symbols containing between 4 and 12 characters, first scan **Code 39 - Length Within Range**. Then scan **0, 4, 1**, and **2** (enter a leading zero for single digit numbers). To correct an error or change the selection, scan [Cancel on page 325](#).
- **Any Length** - Select this option to decode Code 39 symbols containing any number of characters within the RS5100's capability.



Code 39 - One Discrete Length



Code 39 - Two Discrete Lengths



Code 39 - Length Within Range



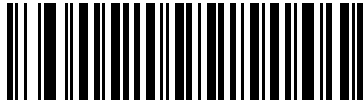
Code 39 - Any Length



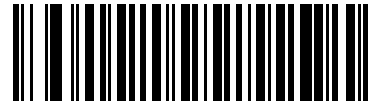
## Code 39 Check Digit Verification

### Parameter # 48 (SSI # 30h)

Enable this feature to check the integrity of all Code 39 symbols to verify that the data complies with specified check digit algorithm. Only Code 39 symbols which include a modulo 43 check digit are decoded. Enable this feature if the Code 39 symbols contain a Modulo 43 check digit.



Enable Code 39 Check Digit  
(1)

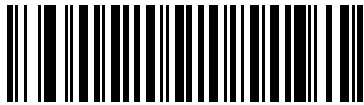


\*Disable Code 39 Check Digit  
(0)

## Transmit Code 39 Check Digit

### Parameter # 43 (SSI # 2Bh)

Scan a barcode below to transmit Code 39 data with or without the check digit.



Transmit Code 39 Check Digit (Enable)  
(1)



\*Do Not Transmit Code 39 Check Digit (Disable)  
(0)

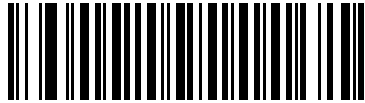


**NOTE:** Code 39 Check Digit Verification must be enabled for this parameter to function.

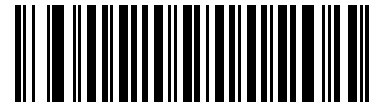
## Code 39 Full ASCII Conversion

### Parameter # 17 (SSI # 11h)

Code 39 Full ASCII is a variant of Code 39 which pairs characters to encode the full ASCII character set. To enable or disable Code 39 Full ASCII, scan the appropriate barcode below.



**Enable Code 39 Full ASCII  
(1)**



**\*Disable Code 39 Full ASCII  
(0)**



**NOTE:** You cannot enable Trioptic Code 39 and Code 39 Full ASCII simultaneously.

Code 39 Full ASCII to Full ASCII Correlation is host-dependent, and is therefore described in the ASCII Character Set Table for the appropriate interface. See the [ASCII Character Sets on page 385](#).

## Code 39 Security Level

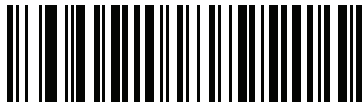
### Parameter # 750 (SSI # F1h EEh)

The RS5100 offers four levels of decode security for Code 39 barcodes. There is an inverse relationship between security and RS5100 aggressiveness. Increasing the level of security can reduce scanning aggressiveness, so select only the level of security necessary.

- **Code 39 Security Level 0:** This setting allows the RS5100 to operate in its most aggressive state, while providing sufficient security in decoding most in-spec barcodes.
- **Code 39 Security Level 1:** This default setting eliminates most misdecodes.
- **Code 39 Security Level 2:** Select this option with greater barcode security requirements if **Security Level 1** fails to eliminate misdecodes.
- **Code 39 Level 3:** If you selected **Security Level 2**, and misdecodes still occur, select this security level to apply the highest safety requirements.



**NOTE:** Selecting this option is an extreme measure against mis-decoding severely out-of-spec barcodes. Selecting this level of security significantly impairs the decoding ability of the RS5100. If this level of security is required, try to improve the quality of the barcodes.



**Code 39 Security Level 0**  
(0)



**\*Code 39 Security Level 1**  
(1)



**Code 39 Security Level 2**  
(2)



**Code 39 Security Level 3**  
(3)

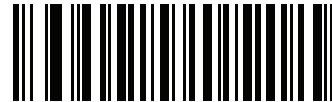
## Code 39 Reduced Quiet Zone

### Parameter # 1209 (SSI # F8h 04h B9h)

Scan one of the following barcodes to enable or disable decoding Code 39 barcodes with reduced quiet zones. If you select **Enable**, select a [1D Quiet Zone Level on page 251](#).



**Enable Code 39 Reduced Quiet Zone**  
(1)



**\*Disable Code 39 Reduced Quiet Zone**  
(0)

## Code 39 Buffering - Scan & Store

### Parameter # 113 (SSI # 71h)

This feature allows the digital scanner to accumulate data from multiple Code 39 symbols.

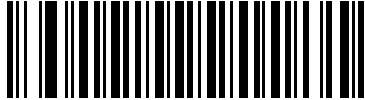
Selecting the Scan and Store option (Buffer Code 39) temporarily buffers all Code 39 symbols having a leading space as a first character for later transmission. The leading space is not buffered.

Decoding a Code 39 symbol with no leading space transmits in sequence all buffered data in a first-in first-out format, plus the “triggering” symbol. See the following pages for further details.

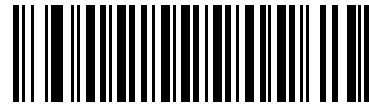
Select **Do Not Buffer Code 39** to transmit all decoded Code 39 symbols immediately without storing them in the buffer.

## Code 39 Buffering - Scan & Store (continued)

This feature affects Code 39 only. If selecting **Buffer Code 39**, we recommend configuring the digital scanner to decode Code 39 symbology only.



**Buffer Code 39 (Enable)**  
(01h)



**\*Do Not Buffer Code 39 (Disable)**  
(00h)

While there is data in the transmission buffer, you cannot select **Do Not Buffer Code 39**. The buffer holds 200 bytes of information.

To disable Code 39 buffering when there is data in the transmission buffer, first force the buffer transmission (see [Transmit Buffer on page 189](#)) or clear the buffer.

### Buffer Data

To buffer data, enable Code 39 buffering and scan a Code 39 symbol with a space immediately following the start pattern.

- Unless the data overflows the transmission buffer, the digital scanner issues a low/high beep to indicate successful decode and buffering. (For overflow conditions, see [Overfilling Transmission Buffer on page 189](#).)
- The digital scanner adds the decoded data excluding the leading space to the transmission buffer.
- No transmission occurs.

### Clear Transmission Buffer

To clear the transmission buffer, scan the **Clear Buffer** barcode below, which contains only a start character, a dash (minus), and a stop character.

- The digital scanner issues a short high/low/high beep.
- The digital scanner erases the transmission buffer.

- No transmission occurs.



**Clear Buffer**



**NOTE:** The Clear Buffer contains only the dash (minus) character. In order to scan this command, set Code 39 lengths to include length 1.

## Transmit Buffer

There are two methods to transmit the Code 39 buffer.

1. Scan the **Transmit Buffer** barcode below, which includes only a start character, a plus (+), and a stop character.
2. The digital scanner transmits and clears the buffer.
  - The digital scanner issues a low/high beep.



**Transmit Buffer**

3. Scan a Code 39 barcode with a leading character other than a space.
  - The digital scanner appends new decode data to buffered data.
  - The digital scanner transmits and clears the buffer.
  - The digital scanner signals that it transmitted the buffer with a low/high beep.
  - The digital scanner transmits and clears the buffer.



**NOTE:** The Transmit Buffer contains only a plus (+) character. In order to scan this command, set Code 39 lengths to include length 1.

## Overfilling Transmission Buffer

The Code 39 buffer holds 200 characters. If the symbol just read overflows the transmission buffer:

- The digital scanner indicates that it rejected the symbol by issuing three long, high beeps.
- No transmission occurs. The data in the buffer is not affected.

## Attempt to Transmit an Empty Buffer

If you scan the **Transmit Buffer** symbol and the Code 39 buffer is empty:

- A short low/high/low beep signals that the buffer is empty.
- No transmission occurs.
- The buffer remains empty.

## Code 93

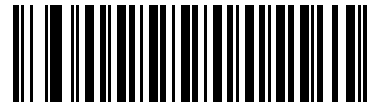
### Enable/Disable Code 93

#### Parameter # 9 (SSI # 09h)

To enable or disable Code 93, scan the appropriate barcode below.



\*Enable Code 93  
(1)



Disable Code 93  
(0)

### Set Lengths for Code 93

#### Parameter # L1 = 26 (SSI # 1Ah), L2 = 27 (SSI # 1Bh)

The length of a code refers to the number of characters (i.e., human readable characters), including check digit(s) the code contains. Set lengths for Code 93 to any length, one or two discrete lengths, or lengths within a specific range. The default is 1 to 55.

- **One Discrete Length** - Select this option to decode only Code 93 symbols containing a selected length. Select the length using the numeric barcodes in [Alphanumeric and Numeric Barcodes](#). For example, to decode only Code 93 symbols with 14 characters, scan **Code 93 - One Discrete Length**, then scan **1** followed by **4**. To correct an error or to change the selection, scan [Cancel on page 325](#).
- **Two Discrete Lengths** - Select this option to decode only Code 93 symbols containing either of two selected lengths. Select lengths using the numeric barcodes in [Alphanumeric and Numeric Barcodes](#). For example, to decode only Code 93 symbols containing either 2 or 14 characters, select **Code 93 - Two Discrete Lengths**, then scan **0, 2, 1**, and then **4**. To correct an error or to change the selection, scan [Cancel on page 325](#).
- **Length Within Range** - Select this option to decode a Code 93 symbol with a specific length range. Select lengths using the numeric barcodes in [Alphanumeric and Numeric Barcodes](#). For example, to decode Code 93 symbols containing between 4 and 12 characters, first scan **Code 93 - Length Within Range**. Then scan **0, 4, 1**, and **2** (enter a leading zero for single digit numbers). To correct an error or change the selection, scan [Cancel on page 325](#).
- **Any Length** - Scan this option to decode Code 93 symbols containing any number of characters within the RS5100's capability.

## Set Lengths for Code 93 (continued)



Code 93 - One Discrete Length



Code 93 - Two Discrete Lengths



Code 93 - Length Within Range



Code 93 - Any Length

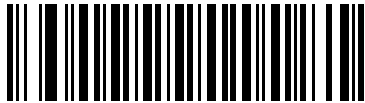


## Code 11

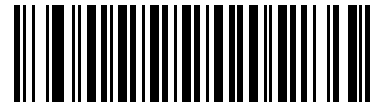
### Code 11

#### Parameter # 10 (SSI # 0Ah)

To enable or disable Code 11, scan the appropriate barcode below.



**Enable Code 11**  
(1)



**\*Disable Code 11**  
(0)

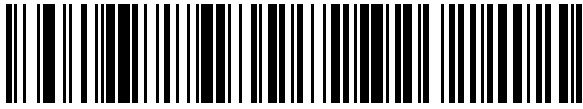
### Set Lengths for Code 11

#### Parameter # L1 = 28 (SSI # 1Ch), L2 = 29 (SSI # 1Dh)

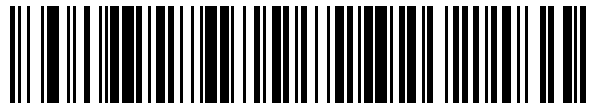
The length of a code refers to the number of characters (i.e., human readable characters), including check digit(s) the code contains. Set lengths for Code 11 to any length, one or two discrete lengths, or lengths within a specific range. The default is 4 to 55.

- **One Discrete Length** - Select this option to decode only Code 11 symbols containing a selected length. Select the length using the numeric barcodes in [Alphanumeric and Numeric Barcodes](#). For example, to decode only Code 11 symbols with 14 characters, scan **Code 11 - One Discrete Length**, then scan **1** followed by **4**. To correct an error or to change the selection, scan [Cancel on page 325](#).
- **Two Discrete Lengths** - Select this option to decode only Code 11 symbols containing either of two selected lengths. Select lengths using the numeric barcodes in [Alphanumeric and Numeric Barcodes](#). For example, to decode only Code 11 symbols containing either 2 or 14 characters, select **Code 11 - Two Discrete Lengths**, then scan **0, 2, 1**, and then **4**. To correct an error or to change the selection, scan [Cancel on page 325](#).
- **Length Within Range** - Select this option to decode a Code 11 symbol with a specific length range. Select lengths using numeric barcodes in [Alphanumeric and Numeric Barcodes](#). For example, to decode Code 11 symbols containing between 4 and 12 characters, first scan **Code 11 - Length Within Range**. Then scan **0, 4, 1**, and **2** (enter a leading zero for single digit numbers). To correct an error or change the selection, scan [Cancel on page 325](#).
- **Any Length** - Scan this option to decode Code 11 symbols containing any number of characters within the RS5100's capability.

### Set Lengths for Code 11 (continued)



Code 11 - One Discrete Length



Code 11 - Two Discrete Lengths



Code 11 - Length Within Range



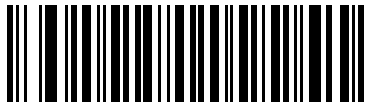
Code 11 - Any Length

## Code 11 Check Digit Verification

### Parameter # 52 (SSI # 34h)

This feature allows the RS5100 to check the integrity of all Code 11 symbols to verify that the data complies with the specified check digit algorithm. This selects the check digit mechanism for the decoded Code 11 barcode. The options are to check for one check digit, check for two check digits, or disable the feature.

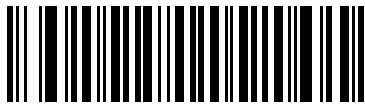
To enable this feature, scan the barcode below corresponding to the number of check digits encoded in the Code 11 symbols.



**\*Disable**  
**(0)**



**One Check Digit**  
**(1)**



**Two Check Digits**  
**(2)**

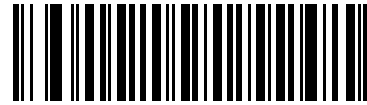
## Transmit Code 11 Check Digits

### Parameter # 47 (SSI # 2Fh)

This feature selects whether or not to transmit the Code 11 check digit(s).



Transmit Code 11 Check Digit(s) (Enable)  
(1)



\*Do Not Transmit Code 11 Check Digit(s) (Disable)  
(0)



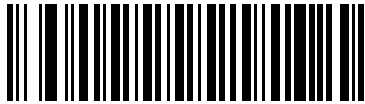
**NOTE:** Code 11 Check Digit Verification must be enabled for this parameter to function.

## Interleaved 2 of 5 (ITF)

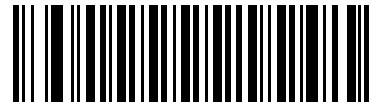
### Enable/Disable Interleaved 2 of 5

#### Parameter # 6 (SSI # 06h)

To enable or disable Interleaved 2 of 5, scan the appropriate barcode below, and select an Interleaved 2 of 5 length from the following pages.



**Enable Interleaved 2 of 5  
(1)**



**\*Disable Interleaved 2 of 5  
(0)**

## Set Lengths for Interleaved 2 of 5

### Parameter # L1 = 22 (SSI # 16h), L2 = 23 (SSI # 17h)

The length of a code refers to the number of characters (i.e., human readable characters), including check digit(s) the code contains. Set lengths for I 2 of 5 to any length, one or two discrete lengths, or lengths within a specific range. The range for Interleaved 2 of 5 lengths is 0 - 55. The default is 6 to 55.

- **One Discrete Length** - Select this option to decode only I 2 of 5 symbols containing a selected length. Select the length using the numeric barcodes in [Alphanumeric and Numeric Barcodes](#). For example, to decode only I 2 of 5 symbols with 14 characters, scan **I 2 of 5 - One Discrete Length**, then scan **1** followed by **4**. To correct an error or to change the selection, scan [Cancel on page 325](#).
- **Two Discrete Lengths** - Select this option to decode only I 2 of 5 symbols containing either of two selected lengths. Select lengths using the numeric barcodes in [Alphanumeric and Numeric Barcodes](#). For example, to decode only I 2 of 5 symbols containing either 2 or 14 characters, select **I 2 of 5 - Two Discrete Lengths**, then scan **0, 2, 1**, and then **4**. To correct an error or to change the selection, scan [Cancel on page 325](#).
- **Length Within Range** - Select this option to decode an I 2 of 5 symbol with a specific length range. Select lengths using numeric barcodes in [Alphanumeric and Numeric Barcodes](#). For example, to decode I 2 of 5 symbols containing between 4 and 12 characters, first scan **I 2 of 5 - Length Within Range**. Then scan **0, 4, 1**, and **2** (enter a leading zero for single digit numbers). To correct an error or change the selection, scan [Cancel on page 325](#).
- **Any Length** - Scan this option to decode I 2 of 5 symbols containing any number of characters within the RS5100's capability.

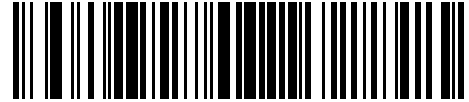


**NOTE:** Due to the construction of the I 2 of 5 symbology, it is possible for a scan line covering only a portion of the code to transmit as a complete scan, yielding less data than is encoded in the barcode. To prevent this, select specific lengths (I 2 of 5 - One Discrete Length, Two Discrete Lengths) for I 2 of 5 applications.

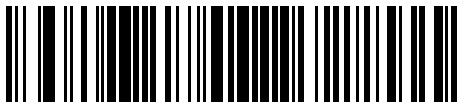
## Set Lengths for Interleaved 2 of 5 (continued)



I 2 of 5 - One Discrete Length



I 2 of 5 - Two Discrete Lengths



I 2 of 5 - Length Within Range



I 2 of 5 - Any Length

## I 2 of 5 Check Digit Verification

### Parameter # 49 (SSI # 31h)

Enable this feature to check the integrity of all I 2 of 5 symbols to verify the data complies with either the specified Uniform Symbology Specification (USS), or the Optical Product Code Council (OPCC) check digit algorithm.



**\*Disable  
(0)**



**USS Check Digit  
(1)**



**OPCC Check Digit  
(2)**



## Transmit I 2 of 5 Check Digit

### Parameter # 44 (SSI # 2Ch)

Scan the appropriate barcode below to transmit I 2 of 5 data with or without the check digit.



Transmit I 2 of 5 Check Digit (Enable)  
(1)

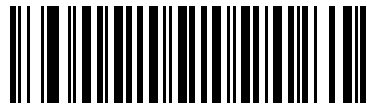


\*Do Not Transmit I 2 of 5 Check Digit (Disable)  
(0)

## Convert I 2 of 5 to EAN-13

### Parameter # 82 (SSI # 52h)

Enable this parameter to convert 14-character I 2 of 5 codes to EAN-13, and transmit to the host as EAN-13. To accomplish this, the I 2 of 5 code must be enabled, and the code must have a leading zero and a valid EAN-13 check digit.



Convert I 2 of 5 to EAN-13 (Enable)  
(1)



\*Do Not Convert I 2 of 5 to EAN-13 (Disable)  
(0)

## I 2 of 5 Security Level

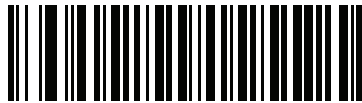
### Parameter # 1121 (SSI # F8h 04h 61h)

Interleaved 2 of 5 barcodes are vulnerable to misdecodes, particularly when I 2 of 5 Lengths is set to **Any Length**. The RS5100 offers four levels of decode security for Interleaved 2 of 5 barcodes. There is an inverse relationship between security and RS5100 aggressiveness. Increasing the level of security can reduce scanning aggressiveness, so select only the level of security necessary.

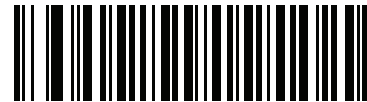
- **I 2 of 5 Security Level 0:** This setting allows the RS5100 to operate in its most aggressive state, while providing sufficient security in decoding most in-spec barcodes.
- **I 2 of 5 Security Level 1:** A barcode must be successfully read twice, and satisfy certain safety requirements before being decoded. This default setting eliminates most misdecodes.
- **I 2 of 5 Security Level 2:** Select this option with greater barcode security requirements if **Security Level 1** fails to eliminate misdecodes.
- **I 2 of 5 Security Level 3:** If you selected **Security Level 2**, and misdecodes still occur, select this security level. The highest safety requirements are applied. A barcode must be successfully read three times before being decoded.



**NOTE:** Selecting this option is an extreme measure against mis-decoding severely out-of-spec barcodes. Selecting this level of security significantly impairs the decoding ability of the RS5100. If this level of security is required, try to improve the quality of the barcodes.



I 2 of 5 Security Level 0  
(00h)



\*I 2 of 5 Security Level 1  
(01h)



I 2 of 5 Security Level 2  
(02h)



I 2 of 5 Security Level 3  
(03h)

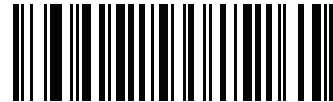
## I 2 of 5 Reduced Quiet Zone

### Parameter # 1210 (SSI # F8h 04h BAh)

Scan one of the following barcodes to enable or disable decoding I 2 of 5 barcodes with reduced quiet zones. If you select **Enable**, select a [1D Quiet Zone Level on page 251](#).



**Enable I 2 of 5 Reduced Quiet Zone  
(1)**



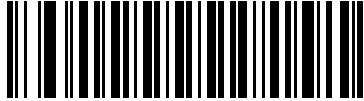
**\*Disable I 2 of 5 Reduced Quiet Zone  
(0)**

## Discrete 2 of 5 (DTF)

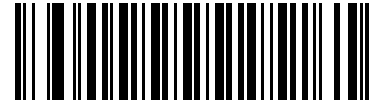
### Enable/Disable Discrete 2 of 5

#### Parameter # 5 (SSI # 05h)

To enable or disable Discrete 2 of 5, scan the appropriate barcode below.



Enable Discrete 2 of 5  
(1)



\*Disable Discrete 2 of 5  
(0)

## Set Lengths for Discrete 2 of 5

### Parameter # L1 = 20 (SSI # 14h), L2 = 21 (SSI # 15h)

The length of a code refers to the number of characters (i.e., human readable characters), including check digit(s) the code contains. Set lengths for D 2 of 5 to any length, one or two discrete lengths, or lengths within a specific range. The range for Discrete 2 of 5 lengths is 1 - 55.

- **One Discrete Length** - Select this option to decode only D 2 of 5 symbols containing a selected length. Select the length using the numeric barcodes in [Alphanumeric and Numeric Barcodes](#). For example, to decode only D 2 of 5 symbols with 14 characters, scan **D 2 of 5 - One Discrete Length**, then scan **1** followed by **4**. To correct an error or to change the selection, scan [Cancel on page 325](#).
- **Two Discrete Lengths** - Select this option to decode only D 2 of 5 symbols containing either of two selected lengths. Select lengths using the numeric barcodes in [Alphanumeric and Numeric Barcodes](#). For example, to decode only D 2 of 5 symbols containing either 2 or 14 characters, select **D 2 of 5 - Two Discrete Lengths**, then scan **0, 2, 1**, and then **4**. To correct an error or to change the selection, scan [Cancel on page 325](#).
- **Length Within Range** - Select this option to decode a D 2 of 5 symbol with a specific length range. Select lengths using numeric barcodes in [Alphanumeric and Numeric Barcodes](#). For example, to decode D 2 of 5 symbols containing between 4 and 12 characters, first scan **D 2 of 5 - Length Within Range**. Then scan **0, 4, 1**, and **2** (enter a leading zero for single digit numbers). To correct an error or change the selection, scan [Cancel on page 325](#).
- **Any Length** - Scan this option to decode D 2 of 5 symbols containing any number of characters within the RS5100's capability.

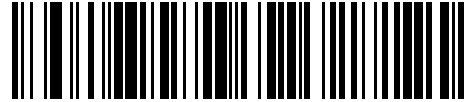


**NOTE:** Due to the construction of the D 2 of 5 symbology, it is possible for a scan line covering only a portion of the code to transmit as a complete scan, yielding less data than is encoded in the barcode. To prevent this, select specific lengths (**D 2 of 5 - One Discrete Length, Two Discrete Lengths**) for D 2 of 5 applications.

## Set Lengths for Discrete 2 of 5 (continued)



D 2 of 5 - One Discrete Length



D 2 of 5 - Two Discrete Lengths



D 2 of 5 - Length Within Range



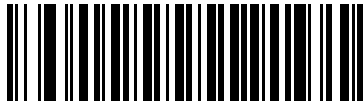
D 2 of 5 - Any Length

## Codabar (NW - 7)

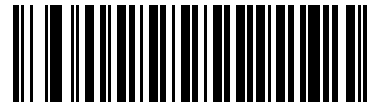
### Enable/Disable Codabar

#### Parameter # 7 (SSI # 07h)

To enable or disable Codabar, scan the appropriate barcode below.



\*Enable Codabar  
(1)



Disable Codabar  
(0)

### Set Lengths for Codabar

#### Parameter # L1 = 24 (SSI # 18h), L2 = 25 (SSI # 19h)

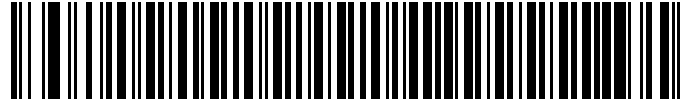
The length of a code refers to the number of characters (i.e., human readable characters), including check digit(s) the code contains. Set lengths for Codabar to any length, one or two discrete lengths, or lengths within a specific range. The default is 4 to 55.

- **One Discrete Length** - Select this option to decode only Codabar symbols containing a selected length. Select the length using the numeric barcodes in [Alphanumeric and Numeric Barcodes](#). For example, to decode only Codabar symbols with 14 characters, scan **Codabar - One Discrete Length**, then scan **1** followed by **4**. To correct an error or to change the selection, scan [Cancel on page 325](#).
- **Two Discrete Lengths** - Select this option to decode only Codabar symbols containing either of two selected lengths. Select lengths using the numeric barcodes in [Alphanumeric and Numeric Barcodes](#). For example, to decode only Codabar symbols containing either 2 or 14 characters, select **Codabar - Two Discrete Lengths**, then scan **0, 2, 1**, and then **4**. To correct an error or to change the selection, scan [Cancel on page 325](#).
- **Length Within Range** - Select this option to decode a Codabar symbol with a specific length range. Select lengths using numeric barcodes in [Alphanumeric and Numeric Barcodes](#). For example, to decode Codabar symbols containing between 4 and 12 characters, first scan **Codabar - Length Within Range**. Then scan **0, 4, 1**, and **2** (enter a leading zero for single digit numbers). To correct an error or change the selection, scan [Cancel on page 325](#).
- **Any Length** - Scan this option to decode Codabar symbols containing any number of characters within the RS5100's capability.

## Set Lengths for Codabar (continued)



Codabar - One Discrete Length



Codabar - Two Discrete Lengths



Codabar - Length Within Range



Codabar - Any Length



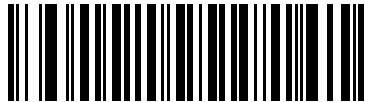
## CLSI Editing

### Parameter # 54 (SSI # 36h)

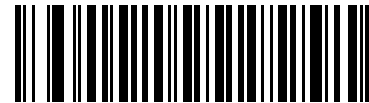
Enable this parameter to strip the start and stop characters and insert a space after the first, fifth, and tenth characters of a 14-character Codabar symbol. Enable this feature if the host system requires this data format.



**NOTE:** Symbol length does not include start and stop characters.



**Enable CLSI Editing  
(1)**

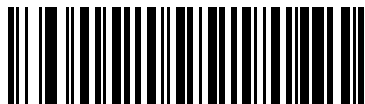


**\*Disable CLSI Editing  
(0)**

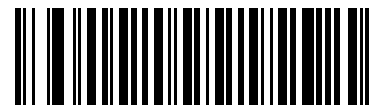
## NOTIS Editing

### Parameter # 55 (SSI # 37h)

Enable this parameter to strip the start and stop characters from a decoded Codabar symbol. Enable this feature if the host system requires this data format.



**Enable NOTIS Editing  
(1)**



**\*Disable NOTIS Editing  
(0)**

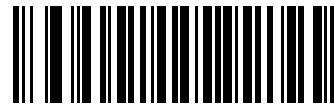
## Codabar Upper or Lower Case Start/Stop Characters Detection

### Parameter # 855 (SSI # F2h 57h)

Select whether to detect upper case or lower case Codabar start/stop characters.



Lower Case  
(1)



\*Upper Case  
(0)

## Codabar Mod 16 Check Digit Verification

### Parameter # 1784 (SSI # F8h 06h F8h)

Enable this feature to check the Codabar Mod 16 Check Digit to verify that the data complies with the specified check digit algorithm.



Enable Codabar Mod 16 Checkdigit  
(1)



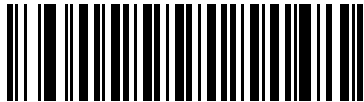
\* Disable Codabar Mod 16 Checkdigit  
(0)

## MSI

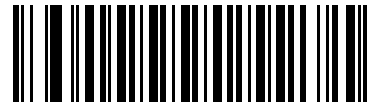
### Enable/Disable MSI

#### Parameter # 11 (SSI # 0Bh)

To enable or disable MSI, scan the appropriate barcode below.



Enable MSI  
(1)



\*Disable MSI  
(0)

### Set Lengths for MSI

#### Parameter # L1 = 30 (SSI # 1Eh), L2 = 31 (SSI # 1Fh)

The length of a code refers to the number of characters (i.e., human readable characters), including check digit(s) the code contains. Set lengths for MSI to any length, one or two discrete lengths, or lengths within a specific range. The default is 4 to 55.

- **One Discrete Length** - Select this option to decode only MSI symbols containing a selected length. Select the length using the numeric barcodes in [Alphanumeric and Numeric Barcodes](#). For example, to decode only MSI symbols with 14 characters, scan **MSI - One Discrete Length**, then scan **1** followed by **4**. To correct an error or to change the selection, scan [Cancel on page 325](#).
- **Two Discrete Lengths** - Select this option to decode only MSI symbols containing either of two selected lengths. Select lengths using the numeric barcodes in [Alphanumeric and Numeric Barcodes](#). For example, to decode only MSI symbols containing either 2 or 14 characters, select **MSI - Two Discrete Lengths**, then scan **0, 2, 1**, and then **4**. To correct an error or to change the selection, scan [Cancel on page 325](#).
- **Length Within Range** - Select this option to decode a MSI symbol with a specific length range. Select lengths using numeric barcodes in [Alphanumeric and Numeric Barcodes](#). For example, to decode MSI symbols containing between 4 and 12 characters, first scan **MSI - Length Within Range**. Then scan **0, 4, 1**, and **2** (enter a leading zero for single digit numbers). To correct an error or change the selection, scan [Cancel on page 325](#).
- **Any Length** - Scan this option to decode MSI symbols containing any number of characters within the RS5100's capability.

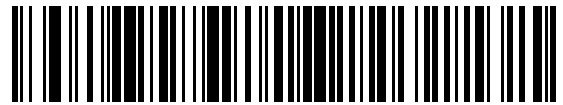
## Set Lengths for MSI (continued)



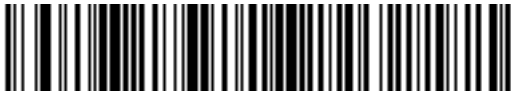
**NOTE:** Due to the construction of the MSI symbology, it is possible for a scan line covering only a portion of the code to transmit as a complete scan, yielding less data than is encoded in the barcode. To prevent this, select specific lengths (**MSI - One Discrete Length, Two Discrete Lengths**) for MSI applications.



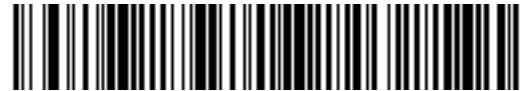
**MSI - One Discrete Length**



**MSI - Two Discrete Lengths**



**MSI - Length Within Range**



**MSI - Any Length**

## MSI Check Digits

### Parameter # 50 (SSI # 32h)

0 - Doesn't check MSI check digit. Decodes MSI with no check digit.

1 - MSI barcodes with 1 check digit. This is the default.

2 - MSI barcodes with 2 check digits.

See [MSI Check Digit Algorithm on page 214](#) for the selection of second digit algorithms.



**NOTE:** This parameter's value semantics have changed from previous models of Zebra scanners. As a result, this parameter is not compatible with current Zebra host devices. An update on the Zebra host devices is in progress.



None (0)



\* One MSI Check Digit (1)

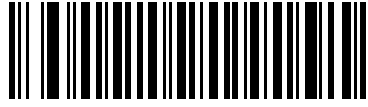


Two MSI Check Digits  
(2)

## Transmit MSI Check Digit(s)

### Parameter # 46 (SSI # 2Eh)

Scan a barcode below to transmit MSI data with or without the check digit.



**Transmit MSI Check Digit(s) (Enable)**  
**(1)**



**\*Do Not Transmit MSI Check Digit(s) (Disable)**  
**(0)**

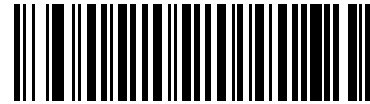
## MSI Check Digit Algorithm

### Parameter # 51 (SSI # 33h)

Two algorithms are possible for the verification of the second MSI check digit. Select the barcode below corresponding to the algorithm used to encode the check digit.



**MOD 10/MOD 11**  
**(0)**



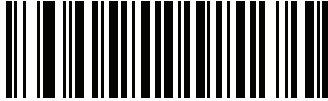
**\*MOD 10/MOD 10**  
**(1)**

## Chinese 2 of 5

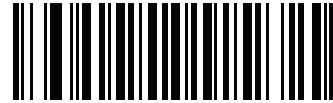
### Enable/Disable Chinese 2 of 5

#### Parameter # 408 (SSI # F0h 98h)

To enable or disable Chinese 2 of 5, scan the appropriate barcode below.



**Enable Chinese 2 of 5  
(1)**



**\*Disable Chinese 2 of 5  
(0)**



## Matrix 2 of 5

### Enable/Disable Matrix 2 of 5

#### Parameter # 618 (SSI # F1h 6Ah)

To enable or disable Matrix 2 of 5, scan the appropriate barcode below.



Enable Matrix 2 of 5  
(1)



\*Disable Matrix 2 of 5  
(0)

### Set Lengths for Matrix 2 of 5

#### Parameter # L1 = 619 (SSI # F1h 6Bh), L2 = 620 (SSI # F1h 6Ch)

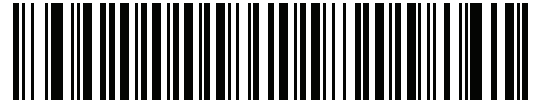
The length of a code refers to the number of characters (i.e., human readable characters), including check digit(s) the code contains. Set lengths for Matrix 2 of 5 to any length, one or two discrete lengths, or lengths within a specific range. The default is 4 to 55.

- **One Discrete Length** - Select this option to decode only Matrix 2 of 5 symbols containing a selected length. Select the length using the numeric barcodes in [Alphanumeric and Numeric Barcodes](#). For example, to decode only Matrix 2 of 5 symbols with 14 characters, scan **Matrix 2 of 5 - One Discrete Length**, then scan **1** followed by **4**. To correct an error or to change the selection, scan [Cancel on page 325](#).
- **Two Discrete Lengths** - Select this option to decode only Matrix 2 of 5 symbols containing either of two selected lengths. Select lengths using the numeric barcodes in [Alphanumeric and Numeric Barcodes](#). For example, to decode only Matrix 2 of 5 symbols containing either 2 or 14 characters, select **Matrix 2 of 5 - Two Discrete Lengths**, then scan **0, 2, 1**, and then **4**. To correct an error or to change the selection, scan [Cancel on page 325](#).
- **Length Within Range** - Select this option to decode a Matrix 2 of 5 symbol with a specific length range. Select lengths using the numeric barcodes in [Alphanumeric and Numeric Barcodes](#). For example, to decode Matrix 2 of 5 symbols containing between 4 and 12 characters, first scan **Matrix 2 of 5 - Length Within Range**. Then scan **0, 4, 1**, and **2** (enter a leading zero for single digit numbers). To correct an error or change the selection, scan [Cancel on page 325](#).
- **Any Length** - Scan this option to decode Matrix 2 of 5 symbols containing any number of characters within the RS5100's capability.

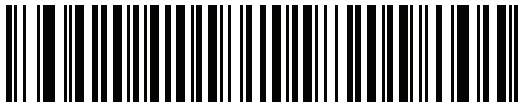
## Set Lengths for Matrix 2 of 5 (continued)



**\*Matrix 2 of 5 - One Discrete Length**



**Matrix 2 of 5 - Two Discrete Lengths**



**Matrix 2 of 5 - Length Within Range**



**Matrix 2 of 5 - Any Length**

## Matrix 2 of 5 Check Digit

### Parameter # 622 (SSI # F1h 6Eh)

The check digit is the last character of the symbol used to verify the integrity of the data. Scan the appropriate barcode below to transmit the barcode data with or without the Matrix 2 of 5 check digit.



**Enable Matrix 2 of 5 Check Digit  
(1)**



**\*Disable Matrix 2 of 5 Check Digit  
(0)**

## Transmit Matrix 2 of 5 Check Digit

### Parameter # 623 (SSI # F1h 6Fh)

Scan a barcode below to transmit Matrix 2 of 5 data with or without the check digit.



**Transmit Matrix 2 of 5 Check Digit  
(1)**



**\*Do Not Transmit Matrix 2 of 5 Check Digit  
(0)**

## Korean 3 of 5

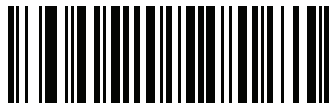
### Enable/Disable Korean 3 of 5

#### Parameter # 581 (SSI # F1h 45h)

To enable or disable Korean 3 of 5, scan the appropriate barcode below.



**NOTE:** The length for Korean 3 of 5 is fixed at 6.



**Enable Korean 3 of 5**  
(1)



**\*Disable Korean 3 of 5**  
(0)

## Inverse 1D

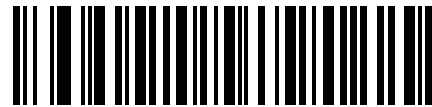
### Parameter # 586 (SSI # F1h 4Ah)

This parameter sets the 1D inverse decoder setting. Options are:

- **Regular Only** - the RS5100 decodes regular 1D barcodes only.
- **Inverse Only** - the RS5100 decodes inverse 1D barcodes only.
- **Inverse Autodetect** - the RS5100 decodes both regular and inverse 1D barcodes.



**\*Regular  
(0)**



**Inverse Only  
(1)**



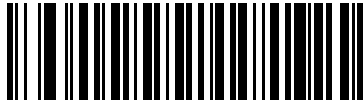
**Inverse Autodetect  
(2)**

## GS1 DataBar

The variants of GS1 DataBar are DataBar-14, DataBar Expanded, and DataBar Limited. The limited and expanded versions have stacked variants. Scan the appropriate barcodes to enable or disable each variant of GS1 DataBar.

### GS1 DataBar-14

#### Parameter # 338 (SSI # F0h 52h)



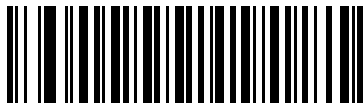
**\*Enable GS1 DataBar-14  
(1)**



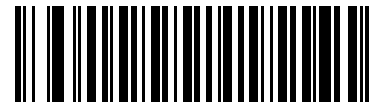
**Disable GS1 DataBar-14  
(0)**

### GS1 DataBar Limited

#### Parameter # 339 (SSI # F0h 53h)



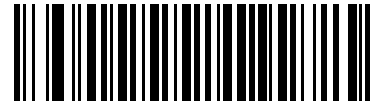
**\*Enable GS1 DataBar Limited  
(1)**



**Disable GS1 DataBar Limited  
(0)**

**GS1 DataBar Expanded****Parameter # 340 (SSI # F0h 54h)**

**\*Enable GS1 DataBar Expanded  
(1)**



**Disable GS1 DataBar Expanded  
(0)**

**Convert GS1 DataBar to UPC/EAN****Parameter # 397 (SSI # F0h, 8Dh)**

This parameter only applies to GS1 DataBar-14 and GS1 DataBar Limited symbols not decoded as part of a Composite symbol. Enable this to strip the leading '010' from DataBar-14 and DataBar Limited symbols encoding a single zero as the first digit, and report the barcode as EAN-13.

For barcodes beginning with two or more zeros but not six zeros, this parameter strips the leading '0100' and reports the barcode as UPC-A. The UPC-A Preamble parameter that transmits the system character and country code applies to converted barcodes. Note that neither the system character nor the check digit can be stripped.



**Enable Convert GS1 DataBar to UPC/EAN  
(1)**



**\*Disable Convert GS1 DataBar to UPC/EAN  
(0)**

## GS1 DataBar Limited Security Level

### Parameter # 728 (SSI # F1h D8h)

The RS5100 offers four levels of decode security for GS1 DataBar Limited barcodes. There is an inverse relationship between security and RS5100 aggressiveness. Increasing the level of security may result in reduced aggressiveness in scanning, so choose only that level of security necessary.

- Level 1 – No clear margin required. This complies with the original GS1 standard, yet might result in erroneous decoding of the DataBar Limited barcode when scanning some UPC symbols that start with digits “9” and “7”
- Level 2 – Automatic risk detection. This level of security may result in erroneous decoding of DataBar Limited barcodes when scanning some UPC symbols. The RS5100 defaults to Level 3, otherwise to Level 1.
- Level 3 – Security level reflects newly proposed GS1 standard that requires a 5 times trailing clear margin.
- Level 4 – Security level extends beyond the standard required by GS1. This level of security requires a 5 times leading and trailing clear margin.



GS1 DataBar Limited Security Level 1  
(1)



GS1 DataBar Limited Security Level 2  
(2)



\*GS1 DataBar Limited Security Level 3  
(3)



GS1 DataBar Limited Security Level 4  
(4)

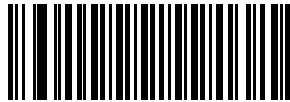


## Composite

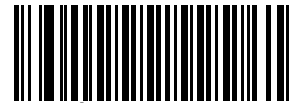
### Composite CC-C

#### Parameter # 341 (SSI # F0h 55h)

Scan a barcode below to enable or disable Composite barcodes of type CC-C.



Enable CC-C  
(1)



\*Disable CC-C  
(0)

### Composite CC-A/B

#### Parameter # 342 (SSI # F0h 56h)

Scan a barcode below to enable or disable Composite barcodes of type CC-A/B.



Enable CC-A/B  
(1)



\*Disable CC-A/B  
(0)

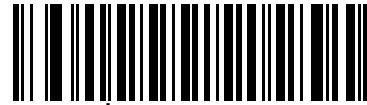
## Composite TLC-39

### Parameter # 371 (SSI # F0h 73h)

Scan a barcode below to enable or disable Composite barcodes of type TLC-39.



Enable TLC39  
(1)



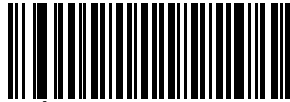
\*Disable TLC39  
(0)

## UPC Composite Mode

### Parameter # 344 (SSI # F0h 58h)

Select an option for linking UPC symbols with a 2D symbol during transmission as if they were one symbol:

- Select **UPC Never Linked** to transmit UPC barcodes regardless of whether a 2D symbol is detected.
- Select **UPC Always Linked** to transmit UPC barcodes and the 2D portion. If 2D is not present, the UPC barcode does not transmit.
- If you select **Autodiscriminate UPC Composites**, the RS5100 determines if there is a 2D portion, then transmits the UPC, as well as the 2D portion if present.



\*UPC Never Linked  
(0)



UPC Always Linked  
(1)

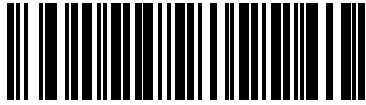


Autodiscriminate UPC Composites  
(2)

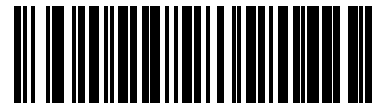
## Composite Beep Mode

### Parameter # 398 (SSI # F0h, 8Eh)

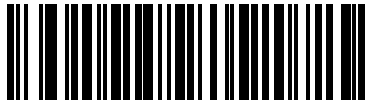
To select the number of decode beeps when a composite barcode is decoded, scan the appropriate barcode.



Single Beep after both are decoded  
(0)



\*Beep as each code type is decoded  
(1)



Double Beep after both are decoded  
(2)

## GS1-128 Emulation Mode for UCC/EAN Composite Codes

### Parameter # 427 (SSI # F0h, ABh)

Select whether to enable or disable this mode.



Enable GS1-128 Emulation Mode for  
UCC/EAN Composite Codes  
(1)



\*Disable GS1-128 Emulation Mode for  
UCC/EAN Composite Codes  
(0)

## 2D Symbologies

### Enable/Disable PDF417

#### Parameter # 15 (SSI # 0Fh)

To enable or disable PDF417, scan the appropriate barcode below.



**\*Enable PDF417**  
(1)



**Disable PDF417**  
(0)

### Enable/Disable MicroPDF417

#### Parameter # 227 (SSI # E3h)

To enable or disable MicroPDF417, scan the appropriate barcode below.



**Enable MicroPDF417**  
(1)



**\*Disable MicroPDF417**  
(0)

## Code 128 Emulation

### Parameter # 123 (SSI # 7Bh)

Enable this parameter to transmit data from certain MicroPDF417 symbols as Code 128. [AIM Code ID Character on page 137](#) must be enabled for this parameter to work.

Enable Code 128 Emulation to transmit these MicroPDF417 symbols with one of the following prefixes:

- ]C1 if the first codeword is 903-905
- ]C2 if the first codeword is 908 or 909
- ]C0 if the first codeword is 910 or 911

Disable Code 128 Emulation to transmit these MicroPDF417 symbols with one of the following prefixes:

- ]L3 if the first codeword is 903-905
- ]L4 if the first codeword is 908 or 909
- ]L5 if the first codeword is 910 or 911

Scan a barcode below to enable or disable Code 128 Emulation.



**NOTE:** Linked MicroPDF codewords 906, 907, 912, 914, and 915 are not supported. Use GS1 Composites instead.



**Enable Code 128 Emulation**  
(1)



**\*Disable Code 128 Emulation**  
(0)

## Data Matrix

### Parameter # 292 (SSI # F0h, 24h)

To enable or disable Data Matrix, scan the appropriate barcode below.



**\*Enable Data Matrix  
(1)**

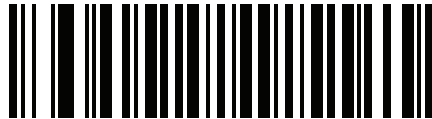


**Disable Data Matrix  
(0)**

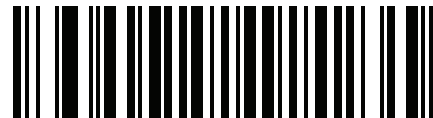
## GS1 Data Matrix

### Parameter # 1336 (SSI # F8h 05h 38h)

To enable or disable GS1 Data Matrix, scan the appropriate barcode below.



**\*Disable GS1 Data Matrix  
(0)**



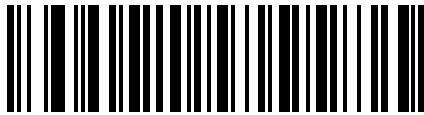
**Enable GS1 Data Matrix  
(1)**

## Data Matrix Inverse

### Parameter # 588 (SSI # F1h 4Ch)

This parameter sets the Data Matrix inverse decoder setting. Options are:

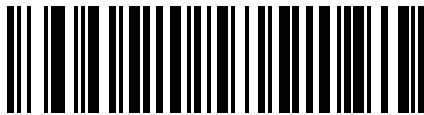
- **Regular Only** - the RS5100 decodes regular Data Matrix barcodes only.
- **Inverse Only** - the RS5100 decodes inverse Data Matrix barcodes only.
- **Inverse Autodetect** - the RS5100 decodes both regular and inverse Data Matrix barcodes.



Regular  
(0)



Inverse Only  
(1)

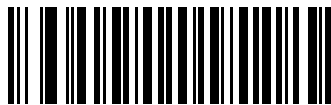


\*Inverse Autodetect  
(2)

## Maxicode

### Parameter # 294 (SSI # F0h, 26h)

To enable or disable Maxicode, scan the appropriate barcode below.



Enable Maxicode  
(1)



\*Disable Maxicode  
(0)



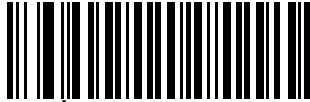
## QR Code

### Parameter # 293 (SSI # F0h, 25h)



**NOTE:** Inverse QR barcodes decode if **QR Code** is enabled.

To enable or disable QR Code, scan the appropriate barcode below.



**\*Enable QR Code**  
(1)

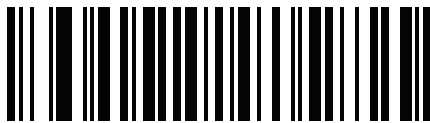


**Disable QR Code**  
(0)

## GS1 QR

### Parameter # 1343 (SSI # F8h 05h 3Fh)

To enable or disable GS1 QR, scan the appropriate barcode below.



**\*Disable GS1 QR**  
(0)

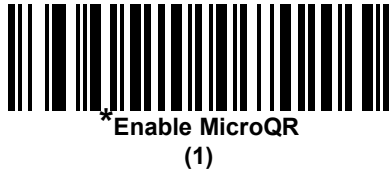


**Enable GS1 QR**  
(1)

## MicroQR

### Parameter # 573 (SSI # F1h 3Dh)

To enable or disable MicroQR, scan the appropriate barcode below.



## Aztec

### Parameter # 574 (SSI # F1h 3Eh)

To enable or disable Aztec, scan the appropriate barcode below.



## Aztec Inverse

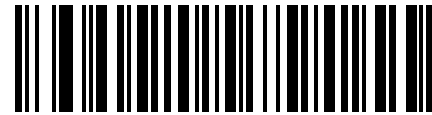
### Parameter # 589 (SSI # F1h 4Dh)

This parameter sets the Aztec inverse decoder setting. Options are:

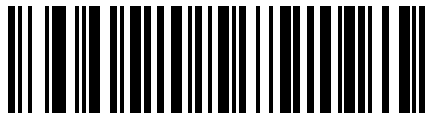
- **Regular Only** - the RS5100 decodes regular Aztec barcodes only.
- **Inverse Only** - the RS5100 decodes inverse Aztec barcodes only.
- **Inverse Autodetect** - the RS5100 decodes both regular and inverse Aztec barcodes.



Regular  
(0)



Inverse Only  
(1)



\*Inverse Autodetect  
(2)

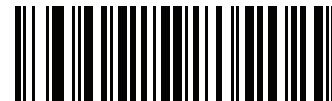
## Han Xin

### Parameter # 1167 (SSI # F8h 04h 8Fh)

To enable or disable Han Xin, scan the appropriate barcode below.



Enable Han Xin  
(1)



\*Disable Han Xin  
(0)

## Han Xin Inverse

### Parameter # 1168 (SSI # F8h 04h 90h)

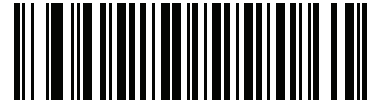
Select a Han Xin inverse decoder setting:

- **Regular Only** - the decoder decodes Han Xin barcodes with normal reflectance only.
- **Inverse Only** - the decoder decodes Han Xin barcodes with inverse reflectance only.

- **Inverse Autodetect** - the decoder decodes both regular and inverse Han Xin barcodes.



**\*Regular  
(0)**



**Inverse Only  
(1)**



**Inverse Autodetect  
(2)**

## DotCode

### Parameter # 1906 (SSI # F8 07 72h)



**NOTE** This parameter is only supported on the SR and HD configurations.

Scan one of the following barcodes to enable or disable DotCode.



**\* Disable DotCode  
(0)**



**Enable DotCode  
(1)**

## DotCode Inverse

### Parameter # 1907 (SSI # F8 07 73h)



**NOTE** This parameter is only supported on the SR and HD configurations.

Scan one of the following barcodes to select a DotCode Inverse decoder setting. Setting options are:

- **Regular Only** - Decoder decodes DotCode barcodes with normal reflectance only.
- **Inverse Only** - Decoder decodes DotCode barcodes with inverse reflectance only.
- **Inverse Autodetect** - Decoder decodes both regular and inverse DotCode barcodes.



**Regular**  
**(0)**



**Inverse Only**  
**(1)**



**\* Autodetect**  
**(2)**

## DotCode Mirrored

### Parameter # 1908 (SSI # F8 07 74h)



**NOTE** This parameter is only supported on the SR and HD configurations.

Scan one of the following barcodes to select a DotCode Mirror decoder setting:

- **Non-Mirrored Only** - Digital scanner decodes non-mirrored DotCode barcodes only.
- **Mirrored Only** - Digital scanner decodes mirrored DotCode barcodes only.
- **Autodetect** - Digital scanner decodes both mirrored and non-mirrored DotCode barcodes.



**Never**  
**(0)**



**Always**  
**(1)**



**\* Autodetect**  
**(2)**

## DotCode Prioritize

### Parameter # 1937 (SSI # F8 07 91h)



**NOTE** This parameter is only supported on the SR and HD configurations.

Enable DotCode Prioritize to give priority to DotCode decoding as compared to other symbologies.



\* **Disable**



**Enable**

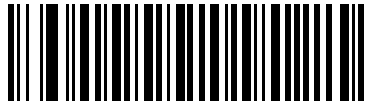


## Postal Codes

### US Postnet

#### Parameter # 89 (SSI # 59h)

To enable or disable US Postnet, scan the appropriate barcode below.



Enable US Postnet  
(1)



\*Disable US Postnet  
(0)

### US Planet

#### Parameter # 90 (SSI # 5Ah)

To enable or disable US Planet, scan the appropriate barcode below.



Enable US Planet  
(1)



\*Disable US Planet  
(0)

## Transmit US Postal Check Digit

### Parameter # 95 (SSI # 5Fh)

Select whether to transmit US Postal data, which includes both US Postnet and US Planet, with or without the check digit.



**\*Transmit US Postal Check Digit  
(1)**



**Do Not Transmit US Postal Check Digit  
(0)**

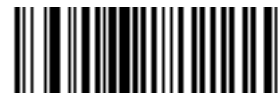
## UK Postal

### Parameter # 91 (SSI # 5Bh)

To enable or disable UK Postal, scan the appropriate barcode below.



**Enable UK Postal  
(1)**



**\*Disable UK Postal  
(0)**

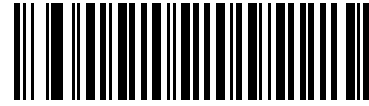
## Transmit UK Postal Check Digit

### Parameter # 96 (SSI # 60h)

Select whether to transmit UK Postal data with or without the check digit.



\*Transmit UK Postal  
Check Digit  
(1)

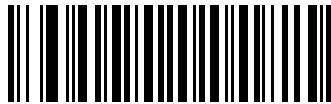


Do Not Transmit UK Postal Check Digit  
(0)

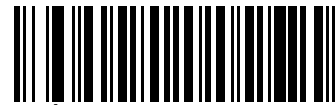
## Japan Postal

### Parameter # 290 (SSI # F0h, 22h)

To enable or disable Japan Postal, scan the appropriate barcode below.



Enable Japan Postal  
(1)



\*Disable Japan Postal  
(0)

## Australia Post

### Parameter # 291 (SSI # F0h, 23h)

To enable or disable Australia Post, scan the appropriate barcode below.



Enable Australia Post  
(1)



\*Disable Australia Post  
(0)

## Australia Post Format

### Parameter # 718 (SSI # F1h, CEh)

To select one of the following formats for Australia Post, scan the appropriate barcode below:

- **Autodiscriminate** (or Smart mode) - Attempt to decode the Customer Information Field using the N and C Encoding Tables.



**NOTE:** This option increases the risk of misdecodes because the encoded data format does not specify the Encoding Table used for encoding.

- **Raw Format** - Output raw bar patterns as a series of numbers 0 through 3.
- **Alphanumeric Encoding** - Decode the Customer Information Field using the C Encoding Table.
- **Numeric Encoding** - Decode the Customer Information Field using the N Encoding Table.

For more information on Australia Post Encoding Tables, refer to the Australia Post Customer Barcoding Technical Specifications available at [auspost.com.au](http://auspost.com.au).



\*Autodiscriminate  
(0)



Raw Format  
(1)



Alphanumeric Encoding  
(2)



Numeric Encoding  
(3)

## Netherlands KIX Code

### Parameter # 326 (SSI # F0h, 46h)

To enable or disable Netherlands KIX Code, scan the appropriate barcode below.



Enable Netherlands KIX Code  
(1)

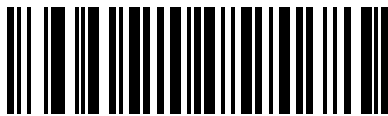


\*Disable Netherlands KIX Code  
(0)

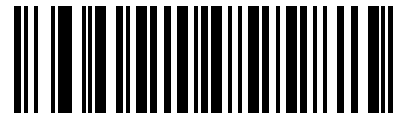
## USPS 4CB/One Code/Intelligent Mail

### Parameter # 592 (SSI # F1h 50h)

To enable or disable USPS 4CB/One Code/Intelligent Mail, scan the appropriate barcode below.



Enable USPS 4CB/One Code/Intelligent Mail  
(1)



\*Disable USPS 4CB/One Code/Intelligent Mail  
(0)

## UPU FICS Postal

### Parameter # 611 (SSI # F1h 63h)

To enable or disable UPU FICS Postal, scan the appropriate barcode below.



Enable UPU FICS Postal  
(1)

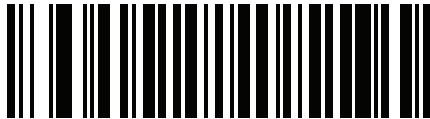


\*Disable UPU FICS Postal  
(0)

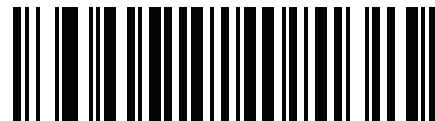
## Mailmark

### Parameter # 1337 (SSI # F8h 05h 39h)

To enable or disable Mailmark, scan the appropriate barcode below.



\*Disable Mailmark  
(0)

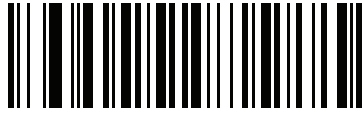


Enable Mailmark  
(1)

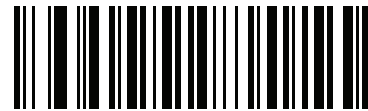
## Canada Post

### Parameter # 92 (SSI # 5Ch)

To enable or disable Canada Post, scan the appropriate barcode below.



**\*Disable Canada Post  
(0)**

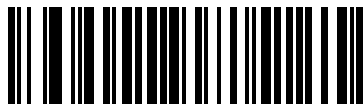


**Enable Canada Post  
(1)**

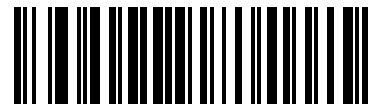
## Posti LAPA 4-State Code

### Parameter # 2031 (SSI # F8 07EF)

To enable or disable Posti LAPA, scan the appropriate barcode below.



**\*Disable Posti LAPA  
(0)**



**Enable Posti LAPA  
(1)**



## Symbology-Specific Security Levels

### Redundancy Level

#### Parameter # 78 (SSI # 4Eh)

The RS5100 offers four levels of decode redundancy. Select higher redundancy levels for decreasing levels of barcode quality. As redundancy levels increase, the RS5100's aggressiveness decreases.

Select the redundancy level appropriate for the barcode quality.

#### Redundancy Level 1

The following code types must be successfully read twice before being decoded:

**Table 9** Redundancy Level 1 Codes

Code Type	Code Length
Codabar	8 characters or less
MSI	4 characters or less
D 2 of 5	8 characters or less
I 2 of 5	8 characters or less

#### Redundancy Level 2

The following code types must be successfully read twice before being decoded:

**Table 10** Redundancy Level 2 Codes

Code Type	Code Length
All	All

#### Redundancy Level 3

Code types other than the following must be successfully read twice before being decoded. The following codes must be read three times:

**Table 11** Redundancy Level 3 Codes

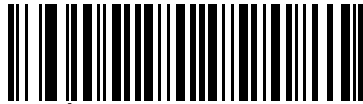
Code Type	Code Length
MSI	4 characters or less
D 2 of 5	8 characters or less
I 2 of 5	8 characters or less
Codabar	8 characters or less

## Redundancy Level 4

The following code types must be successfully read three times before being decoded:

**Table 12** Redundancy Level 4 Codes

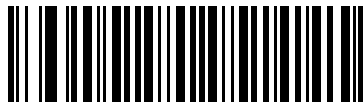
Code Type	Code Length
All	All



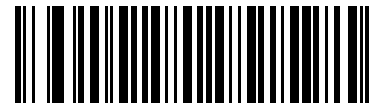
\*Redundancy Level 1  
(1)



Redundancy Level 2  
(2)



Redundancy Level 3  
(3)



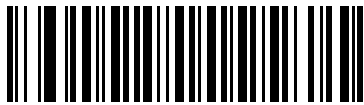
Redundancy Level 4  
(4)

## Security Level

### Parameter # 77 (SSI # 4Dh)

The RS5100 offers four levels of decode security for delta barcodes, which include the Code 128 family, UPC/EAN, and Code 93. Select increasing levels of security for decreasing levels of barcode quality. There is an inverse relationship between security and RS5100 aggressiveness, so choose only that level of security necessary for any given application.

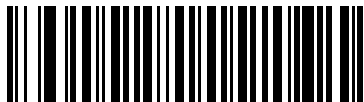
- **Security Level 0:** This setting allows the RS5100 to operate in its most aggressive state, while providing sufficient security in decoding most “in-spec” barcodes.
- **Security Level 1:** This default setting eliminates most misdecodes.
- **Security Level 2:** Select this option if Security level 1 fails to eliminate misdecodes.
- **Security Level 3:** If you selected Security Level 2 and misdecodes still occur, select this security level. Be advised, selecting this option is an extreme measure against mis-decoding severely out of spec barcodes. Selecting this level of security significantly impairs the decoding ability of the RS5100. If you need this level of security, try to improve the quality of the barcodes.



Security Level 0  
(0)



\*Security Level 1  
(1)



Security Level 2  
(2)



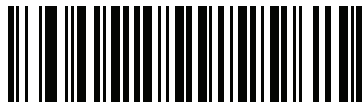
Security Level 3  
(3)

## 1D Quiet Zone Level

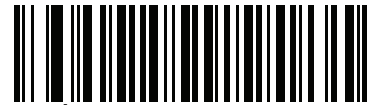
### Parameter # 1288 (SSI # F8h 05h 08h)

This feature sets the level of aggressiveness in decoding barcodes with a reduced quiet zone (the area in front of and at the end of a barcode), and applies to symbologies enabled by a Reduced Quiet Zone parameter. Because higher levels increase the decoding time and risk of misdecodes, Symbol Technologies strongly recommends enabling only the symbologies which require higher quiet zone levels, and leaving Reduced Quiet Zone disabled for all other symbologies. Options are:

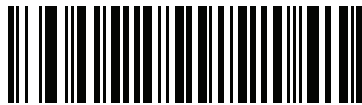
- 0 - The RS5100 performs normally in terms of quiet zone.
- 1 - The RS5100 performs more aggressively in terms of quiet zone.
- 2 - The RS5100 only requires one side EB (end of barcode) for decoding.
- 3 - The RS5100 decodes anything in terms of quiet zone or end of barcode.



1D Quiet Zone Level 0  
(0)



\*1D Quiet Zone Level 1  
(1)



1D Quiet Zone Level 2  
(2)

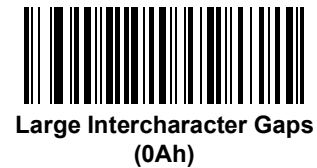


1D Quiet Zone Level 3  
(3)

## Intercharacter Gap Size

### Parameter # 381 (SSI # F0h, 7Dh)

The Code 39 and Codabar symbologies have an intercharacter gap that is typically quite small. Due to various barcode-printing technologies, this gap can grow larger than the maximum size allowed, preventing the RS5100 from decoding the symbol. If this problem occurs, scan the **Large Intercharacter Gaps** parameter to tolerate these out-of-specification barcodes.



---

## Report Version

Scan the barcode below to report the version of software installed in the RS5100.



## Macro PDF Features

Macro PDF is a special feature for concatenating multiple PDF symbols into one file. The RS5100 can decode symbols that are encoded with this feature, and can store more than 64 Kb of decoded data stored in up to 50 MacroPDF symbols.



**CAUTION:** When printing, keep each Macro PDF sequence separate, as each sequence has unique identifiers. Do not mix barcodes from several Macro PDF sequences, even if they encode the same data. When scanning Macro PDF sequences, scan the entire Macro PDF sequence without interruption. If, when scanning a mixed sequence, the RS5100 emits two long low beeps (Low/Low) this indicates an inconsistent file ID or inconsistent symbology error.

## Flush Macro Buffer

This flushes the buffer of all decoded Macro PDF data stored to that point, transmits it to the host device, and aborts from Macro PDF mode.



**Flush Macro PDF Buffer**

## Abort Macro PDF Entry

This clears all currently-stored Macro PDF data in the buffer without transmission and aborts from Macro PDF mode.



**Abort Macro PDF Entry**

# Digimarc Barcode

---

## Introduction

Digimarc Barcode is an invisible machine-readable code.

---

## Digimarc Symbology

Digimarc codes are reported as UPC-A, UPC-E, EAN-13, or GS1 DataBar Expanded.



**NOTE:** Converting the Digimarc reported code types to other barcode types is not supported.

AIM and Symbol code IDs are supported for the reported Digimarc code types.

## Picklist

The Digimarc decoder searches configured block areas of the image for Digimarc codes, and operates the same regardless of whether Picklist Mode is enabled or disabled.



**NOTE:** Decode time can be greater in Picklist Mode due to the additional processing required by the system and decoder.

---

## Digimarc Digital Watermarks

### Parameter # 1687 (SSI # F8h 06h 97h)

Scan the appropriate barcode to enable or disable the Digimarc Digital Watermarks code.



**Enable Digimarc Digital Watermarks  
(1)**



**\*Disable Digimarc Digital Watermarks  
(0)**



# Data Formatting: ADF, MDF, Preferred Symbol

---

## Introduction

This chapter briefly describes the Zebra features available for customizing scanner operation.

---

## Advanced Data Formatting (ADF)

Advanced Data Formatting (ADF) allows customizing data before transmission to the host device. Use ADF to edit scanned data to suit the host application's requirements. With ADF you scan one barcode per trigger pull. ADF is programmed using 123Scan.

For a video on Creating an Advanced Data Formatting (ADF) Rule using 123Scan, go to: [www.zebra.com/ScannerHowToVideos](http://www.zebra.com/ScannerHowToVideos).

For additional information, refer to the Advanced Data Formatting Programmer Guide.

---

## Multicode Data Formatting (Hand-held Mode Only)

Multicode Data Formatting (MDF) enables a 2D scanner to scan all barcodes on a label with a single trigger pull, and then modify and transmit the data to meet host application requirements. MDF supports programming up to nine unique labels into one scanner. MDF also supports scanning multiple barcodes on opposite sides of a box by holding the trigger.

MDF options include:

- Output all or specific barcodes.
- Control the barcode output sequence.
- Apply unique multicode data formatting (MDF) to each output barcode.
- Discard scanned data if all required barcodes are not present.

## Programming a Scanner

- Using 123Scan, programming an MDF is similar to programming an ADF rule. MDF programming is saved in a 123Scan configuration file.
- MDF can be deployed to a fleet of 2D scanners using the Scanner Management Service (SMS) through a traditional SMS package.

For more information, refer to the Multicode Data Formatting and Preferred Symbol User Guide, p/n MN-002895-xx.

For a video on Creating an Multicode Data Formatting (MDF) Rule using 123Scan, go to: [www.zebra.com/ScannerHowToVideos](http://www.zebra.com/ScannerHowToVideos).

---

## Preferred Symbol

Preferred Symbol is a barcode prioritization technique that enables favored decoding of high priority barcode(s). The Preferred Symbol is the only barcode that is decoded and output within the preset Preferred Symbol Timeout. During this time, the scanner attempts to decode the prioritized barcode and reports only this barcode.

For more information, refer to the Multicode Data Formatting and Preferred Symbol User Guide, p/n MN-002895-xx.

To program Preferred Symbol via 123Scan, select 123Scan > Configuration Wizard > Symbologies screen, and then select Preferred Symbol from the drop-down menu. Preferred Symbol programming is saved in the 123Scan configuration file.

# OCR Programming

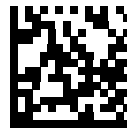
## Introduction

This chapter describes how to set up the digital scanner for OCR programming. The digital scanner can read 6 to 60 point OCR typeface. It supports font types OCR-A, OCR-B, MICR-E13B, and US Currency Serial Number.

OCR is not as secure as a barcode. To decrease OCR misdecodes and speed OCR reading, set an accurate OCR template and character subset, and use a check digit.

All OCR fonts are disabled by default. Enabling OCR can slow barcode decoding. Enabling more than one OCR font could also slow OCR decoding and impact OCR decoding accuracy.

Throughout the programming barcode menus, asterisks (\*) indicate default values. OCR Parameter Defaults



\* Indicates Default      \* **Disable OCR-A**      Feature/Option



**NOTE:** OCR pertains to the DS36X8-HP configuration only.



**NOTE:** Most computer monitors allow scanning the barcodes directly on the screen. When scanning from the screen, be sure to set the document magnification to a level where you can see the barcode clearly, and bars and/or spaces are not merging.

Table 13 lists the defaults for OCR parameters. To change any option, scan the appropriate barcode(s) provided in the Parameter Descriptions section beginning on [page 260](#).



**NOTE:** See [Standard Default Parameters](#) for all user preferences, hosts, symbologies, and default parameters.

**Table 13** OCR Programming Default Table

Parameter	Parameter Number	SSI Number	Default	Page Number
OCR Programming Parameters				
OCR-A	680	F1h A8h	Disable	<a href="#">260</a>
OCR-A Variant	684	F1h ACh	Full ASCII	<a href="#">261</a>

**Table 13** OCR Programming Default Table (Continued)

Parameter	Parameter Number	SSI Number	Default	Page Number
OCR-B	681	F1h A9h	Disable	<a href="#">263</a>
OCR-B Variant	685	F1h ADh	Full ASCII	<a href="#">264</a>
MICR E13B	682	F1h AAh	Disable	<a href="#">268</a>
US Currency	683	F1h ABh	Disable	<a href="#">269</a>
OCR Orientation	687	F1h AFh	0°	<a href="#">269</a>
OCR Lines	691	F1h B3h	1	<a href="#">271</a>
OCR Minimum Characters	689	F1h B1h	3	<a href="#">271</a>
OCR Maximum Characters	690	F1h B2h	100	<a href="#">272</a>
OCR Subset	686	F1h AEh	Selected font variant	<a href="#">272</a>
OCR Quiet Zone	695	F1h B7h	50	<a href="#">273</a>
OCR Template	547	F1h 23h	99999999	<a href="#">274</a>
OCR Check Digit Modulus	688	F1h B0h	1	<a href="#">283</a>
OCR Check Digit Multiplier	700	F1h BCh	121212121212	<a href="#">284</a>
OCR Check Digit Validation	694	F1h B6h	None	<a href="#">286</a>
Inverse OCR	856	F2h 58h	Regular	<a href="#">291</a>
OCR Redundancy	1770	F8h 06h EAh	Level 1	<a href="#">292</a>

---

## OCR Programming Parameters

### Enable/Disable OCR-A

#### Parameter # 680 (SSI # F1h A8h)

To enable or disable OCR-A, scan one of the following barcodes.



**NOTE:** OCR is not as secure as a barcode. To decrease OCR misdecodes and speed OCR reading, set an accurate OCR template and character subset, and use a check digit. See [OCR Subset on page 272](#) and [OCR Template on page 274](#).



**NOTE:** All OCR fonts are disabled by default. Enabling OCR can slow barcode decoding. Enabling more than one OCR font could also slow OCR decoding and impact OCR decoding accuracy.



Enable OCR-A  
(1)



\* Disable OCR-A  
(0)

## OCR-A Variant

### Parameter # 684 (SSI # F1 ACh)

Font variant sets a processing algorithm and default character subset for the given font. To choose a variant, scan one of the following barcodes. Selecting the most appropriate font variant optimizes performance and accuracy.

OCR-A supports the following variants:

- OCR-A Full ASCII  
! "\$ % ' ( ) \* + , - . / 0 1 2 3 4 5 6 7 8 9 < > A B C D E F G H I J K L M N O P Q R S T U V W X Y Z \ ^
- OCR-A Reserved 1  
\$ \* + - . / 0 1 2 3 4 5 6 7 8 9 A B C D E F G H I J K L M N O P Q R S T U V W X Y Z
- OCR-A Reserved 2  
\$ \* + - . / 0 1 2 3 4 5 6 7 8 9 < > A B C D E F G H I J K L M N O P Q R S T U V W X Y Z
- OCR-A Banking  
- 0 1 2 3 4 5 6 7 8 9 < > ƒ Ɔ ɦ

Special banking characters output as the following representative characters:

ƒ outputs as f

Ɔ outputs as c

ɦ outputs as h



**NOTE:** Enable OCR-A before setting this parameter. If disabling OCR-A, set the variant to its default (OCR-A Full ASCII).

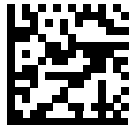
OCR-A Variant (continued)



\* OCR-A Full ASCII  
(0)



OCR-A Reserved 1  
(1)



OCR-A Reserved 2  
(2)



OCR-A Banking  
(3)

## Enable/Disable OCR-B

### Parameter # 681 (SSI # F1h A9h)

To enable or disable OCR-B, scan one of the following barcodes.



**NOTE:** OCR is not as secure as a barcode. To decrease OCR misdecodes and speed OCR reading, set an accurate OCR template and character subset, and use a check digit. See [OCR Subset on page 272](#) and [OCR Template on page 274](#).



**NOTE:** All OCR fonts are disabled by default. Enabling OCR can slow barcode decoding. Enabling more than one OCR font could also slow OCR decoding and impact OCR decoding accuracy.



**Enable OCR-B  
(1)**



**\* Disable OCR-B  
(0)**



## OCR-B Variant

### Parameter # 685 (SSI # F1h ADh)

OCR-B has the following variants. Selecting the most appropriate font variant affects performance and accuracy.

- OCR-B Full ASCII  
!#\$%()\*+,-./0123456789<>ABCDEFGHIJKLMNOPQRSTUVWXYZ^|ñ
- OCR-B Banking  
#+-0123456789<>JNP|
- OCR-B Limited  
+,-./0123456789<>ACENPSTVX
- OCR-B ISBN 10-Digit Book Numbers  
-0123456789>BCEINPSXz
- OCR-B ISBN 10 or 13-Digit Book Numbers  
-0123456789>BCEINPSXz
- OCR-B Travel Document Version 1 (TD1) 3-Line ID Cards  
-0123456789<ABCDEFGHIJKLMNOPQRSTUVWXYZ
- OCR-B Travel Document Version 2 (TD2) 2-Line ID Cards  
-0123456789<ABCDEFGHIJKLMNOPQRSTUVWXYZ
- OCR-B Travel Document 2 or 3-Line ID Cards Auto-Detect  
!#\$%()\*+,-./0123456789<>ABCDEFGHIJKLMNOPQRSTUVWXYZ^|ñ
- OCR-B Passport  
-0123456789<ABCDEFGHIJKLMNOPQRSTUVWXYZñ
- OCR-B Visa Type A  
-0123456789<ABCDEFGHIJKLMNOPQRSTUVWXYZ
- OCR-B Visa Type B  
-0123456789<ABCDEFGHIJKLMNOPQRSTUVWXYZñ
- OCR-B ICAO Travel Documents  
This allows reading either TD1, TD2, Passport, Visa Type A, or Visa Type B without switching between these options. It automatically recognizes the travel document read.

To choose a variant, scan one of the following barcodes. Selecting the following OCR-B variants automatically sets the appropriate [OCR Lines on page 271](#). These five variants invoke extensive special algorithms and checking for that particular document type:

VariantOCR Lines Setting

Passport2

TD1 ID Cards3

TD2 ID Cards2

Visa Type A2

Visa Type B2

Selecting one of the ISBN Book Numbers automatically applies the appropriate ISBN checksum, so you do not need to set this.

## OCR-B Variant (continued)

For the best performance in passport reading, fix the target passport and the decoder in place (6.5 - 7.5”).



**NOTE:** Enable OCR-B before setting this parameter. If disabling OCR-B, set the variant to its default (OCR-B Full ASCII).



\* OCR-B Full ASCII  
(0)



OCR-B Banking  
(1)

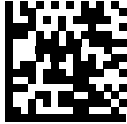


OCR-B Limited  
(2)



OCR-B ISBN 10-Digit Book Numbers  
(6)

**OCR-B Variant (continued)**



**OCR-B ISBN 10 or 13-Digit Book Numbers  
(7)**



**OCR-B Travel Document Version 1 (TD1)  
3 Line ID Cards  
(3)**



**OCR-B Travel Document Version 2 (TD2)  
2-Line ID Cards  
(8)**



**Travel Document 2 or 3-Line ID Cards Auto-Detect  
(20)**

**OCR-B Variant (continued)**



**OCR-B Passport  
(4)**



**OCR-B Visa Type A  
(9)**



**OCR-B Visa Type B  
(10)**



**OCR-B ICAO Travel Documents  
(11)**



## Enable/Disable US Currency Serial Number

### Parameter # 683 (SSI # F1h ABh)

To enable or disable US Currency Serial Number, scan one of the following barcodes.



**NOTE:** OCR is not as secure as a barcode. To decrease OCR misdecodes and speed OCR reading, set an accurate OCR template and character subset, and use a check digit. See [OCR Subset on page 272](#) and [OCR Template on page 274](#).



**NOTE:** All OCR fonts are disabled by default. Enabling OCR can slow barcode decoding. Enabling more than one OCR font could also slow OCR decoding and impact OCR decoding accuracy.



**Enable US Currency  
(1)**



**\* Disable US Currency  
(0)**

## OCR Orientation

### Parameter # 687 (SSI # F1h AFh)

Select one of five options to specify the orientation of an OCR string to be read:

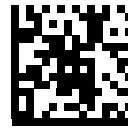
- 0° to the imaging engine (default)
- 270° clockwise (or 90° counterclockwise) to the imaging engine
- 180° (upside down) to the imaging engine
- 90° clockwise to the imaging engine
- Omnidirectional

Setting an incorrect orientation can cause misdecodes.

**OCR Orientation (continued)**



**\* OCR Orientation 0°  
(0)**



**OCR Orientation 270° Clockwise  
(1)**



**OCR Orientation 180° Clockwise  
(2)**



**OCR Orientation 90° Clockwise  
(3)**



**OCR Orientation Omnidirectional  
(4)**

## OCR Lines

### Parameter # 691 (SSI # F1h B3h)

To select the number of OCR lines to decode, scan one of the following barcodes. Selecting Visas, TD1, or TD2 ID cards automatically sets the appropriate **OCR Lines**. Also see [OCR-B Variant on page 264](#).



\* OCR 1 Line  
(1)



OCR 2 Lines  
(2)



OCR 3 Lines  
(3)

## OCR Minimum Characters

### Parameter # 689 (SSI # F1h B1h)

To select the minimum number of OCR characters (not including spaces) per line to decode, scan the following barcode, then scan a three-digit number between 003 and 100 using the barcodes in [Alphanumeric and Numeric Barcodes](#) representing the number of OCR characters to decode. Strings of OCR characters less than the minimum are ignored. The default is 003.



OCR Minimum Characters



## OCR Maximum Characters

### Parameter # 690 (SSI # F1h B2h)

To select the maximum number of OCR characters (including spaces) per line to decode, scan the following barcode, then scan a three-digit number between 003 and 100 using the barcodes in [Alphanumeric and Numeric Barcodes](#) representing the number of OCR characters to decode. Strings of OCR characters greater than the maximum are ignored. The default is 100.



OCR Maximum Characters

## OCR Subset

### Parameter # 686 (SSI # F1h AEh)

Set an OCR subset to define a custom group of characters in place of a preset font variant. For example, if scanning only numbers and the letters A, B, and C, create a subset of just these characters to speed decoding. This applies a designated OCR Subset across all enabled OCR fonts.

To set or modify the OCR font subset, first enable the appropriate OCR font(s). Next, scan the following barcode, then scan numbers and letters to form the OCR Subset from the alphanumeric keyboard in the *Advanced Data Formatting Guide*. Then scan **End of Message** in the *Advanced Data Formatting Guide*.



OCR Subset

To cancel an OCR subset, for OCR-A or OCR-B, set OCR-A variant **Full ASCII**, or OCR-B variant **Full ASCII**, and set subset to **NULL string**.

For MICR E13B or US Currency Serial Number, create a subset which includes all allowed characters in that character set, or scan an option from the [Standard Default Parameters on page 309](#) and re-program the digital scanner.

## OCR Quiet Zone

### Parameter # 695 (SSI # F1h B7h)

This option sets the OCR quiet zone. The digital scanner stops scanning a field when it detects a sufficiently wide blank space. The width of this space is defined by the End of Field option. Used with parsers that tolerate slanted characters, the End of Field count is roughly a count of 8 for a character width. For example if set to 15, then two character widths are an end of line indicator for the parser. Larger end of field numbers require bigger quiet zones at each end of text line.

To set a quiet zone, scan the following barcode, then scan a two-digit number using the numeric keypad in the *Advanced Data Formatting Guide*. The range of the quiet zone is 20 - 99 and the default is 50, indicating a six character width quiet zone.



OCR Quiet Zone

## OCR Template

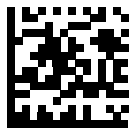
### Parameter # 547 (SSI # F1h 23h)

This option creates a template for precisely matching scanned OCR characters to a desired input format. Carefully constructing an OCR template eliminates scanning errors.

To set or modify the OCR decode template, scan the [OCR Template](#) barcode, then barcodes corresponding to numbers and letters on the following pages to form the template expression. Then scan **End of Message** in the *Advanced Data Formatting Guide*. The default is **99999999** which accepts OCR strings only containing eight digits.



OCR Template



End of Message

### Required Digit (9)

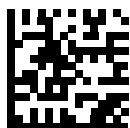


9

Only a numeric character is allowed in this position.

Template	Valid data	Valid data	Invalid data
99999	12987	30517	123AB

### Required Alpha (A)



A

Only an alpha character is allowed in this position.

Template	Valid data	Valid data	Invalid data
AAA	ABC	WXY	12F

## Optional Alphanumeric (1)



1

When this option appears in the template string, the data validator accepts an alphanumeric character if present. Optional characters are not allowed as the first character(s) in a field of like characters.

Template	Valid data	Valid data	Invalid data
99991	1234A	12345	1234<

## Optional Alpha (2)



2

When this option appears in the template string, the data validator accepts an alpha character if present. Optional characters are not allowed as the first character(s) in a field of like characters.

Template	Valid data	Valid data	Invalid data
AAAA2	ABCDE	WXYZ	ABCD6

## Alpha or Digit (3)



3

The data validator requires an alphanumeric character in this position to validate the incoming data.

Template	Valid data	Valid data	Invalid data
33333	12ABC	WXY34	12AB<

### Any Including Space & Reject (4)



4

The template accepts any character in this position, including space and reject. Rejects are represented as an underscore (\_) in the output. This is a good selection for troubleshooting.

Template	Valid data	Valid data
99499	12\$34	34_98

### Any except Space & Reject (5)



5

The template accepts any character in this position except a space or reject.

Template	Valid data	Valid data	Invalid data
55999	A.123	*Z456	A BCD

### Optional Digit (7)



7

When this option appears in the template string, the template accepts a numeric character if present. Optional characters are not allowed as the first character(s) in a field of like characters.

Template	Valid data	Valid data	Invalid data
99977	12345	789	789AB

### Digit or Fill (8)



8

The data validator accepts any numeric or fill character in this position.

Template	Valid data	Valid data	Valid data
88899	12345	>>789	<<789

### Alpha or Fill (F)



F

The data validator accepts any alpha or fill character in this position.

Template	Valid data	Valid data	Valid data
AAAFF	ABCXY	LMN>>	ABC<5

### Optional Space ( )



Space

When this option appears in the template string, the template accepts a space if present. Optional characters are not allowed as the first character(s) in a field of like characters.

Template	Valid data	Valid data	Invalid data
99 99	12 34	1234	67891

## Optional Small Special (.)



.

When this option appears in the template string, the data validator accepts a special character if present. Optional characters are not allowed as the first character(s) in a field of like characters. Small special characters are -, , and .

Template	Valid data	Valid data	Invalid data
AA.99	MN.35	XY98	XYZ12

## Other Template Operators

These template operators assist in capturing, delimiting, and formatting scanned OCR data.

### Literal String (" and +)



"



+

Use either of these delimiting characters surrounding characters from the alphanumeric keyboard in the *Advanced Data Formatting Guide* to define a literal string within a template that must be present in scanned OCR data. There are two characters used to delimit required literal strings; if one of the delimiter characters is present in the desired literal string, use the other delimiter.

Template	Valid data	Invalid data
"35+BC"	35+BC	AB+22

**New Line (E)**



**E**

To create a template of multiple lines, add **E** between the template of each single line.

Template	Valid data	Valid data	Invalid data
999EAAAA	321	987	XYZW
	BCAD	ZXYW	12

**String Extract (C)**



**C**

This operator combined with others defines a string of characters to extract from the scanned data. The string extract is structured as follows:

CbPe

Where:

- **C** is the string extract operator
- **b** is the string begin delimiter
- **P** is the category (one or more numeric or alpha characters) describing the string representation
- **e** is the string end delimiter

Values for **b** and **e** can be any scannable character. They are included in the output stream.

Template	Incoming data	Output
C>A>	XQ3>ABCDE>	>ABCDE>
	->ATHRUZ>123	>ATHRUZ>
	1ABCXYZ	No Output



**Ignore to End of Field (D)****D**

This operator causes all characters after a template to be ignored. Use this as the last character in a template expression. Examples for the template 999D:

Template	Incoming data	Output
999D	123-PED	123
	357298	357
	193	193

**Skip Until (P1)****P****1**

This operator allows skipping over characters until a specific character type or a literal string is detected. It can be used in two ways:

```
P1ct
```

Where:

- P1 is the Skip Until operator
- c is the type of character that triggers the start of output
- t is one or more template characters

```
P1"s"t
```

Where:

- P1 is the Skip Until operator
- "s" is one or more literal string characters (see [Literal String \(" and +\) on page 278](#)) that trigger the start of output

- `t` is one or more template characters

The trigger character or literal string is included in output from a Skip Until operator, and the first character in the template should accommodate this trigger.

Template	Incoming data	Output
<code>P1"PN"AA9999</code>	123PN9876	PN9876
	PN1234	PN1234
	X-PN3592	PN3592

## Skip Until Not (P0)



P



0

This operator allows skipping over characters until a specific character type or a literal string is not matched in the output stream. It can be used in two ways:

`P0ct`

Where:

- `P0` is the Skip Until Not operator
- `c` is the type of character that triggers the start of output
- `t` is one or more template characters

`P0"s"t`

Where:

- `P0` is the Skip Until Not operator
- `"s"` is one or more literal string characters (see [Literal String \(" and +\) on page 278](#)) that trigger the start of output
- `t` is one or more template characters

The trigger character or literal string is not included in output from a Skip Until Not operator.

Template	Incoming data	Output
P0A9999	BN3456	3456
	PN1234	1234
	5341	No output

Template	Incoming data	Output
P0"PN"9999	PN3456	3456
	5341	No output
	PNPN7654	7654

### ***Repeat Previous (R)***



**R**

This operator allows a template character to repeat one or more times, allowing the capture of variable-length scanned data. The following examples capture two required alpha characters followed by one or more required digits:

Template	Incoming data	Output
AA9R	AB3	AB3
	PN12345	PN12345
	32RM52700	No output

### ***Scroll Until Match (S)***



**S**

This operator steps through scanned data one character at a time until the data matches the template.

Template	Incoming data	Output
S99999	AB3	No Output
	PN12345	12345
	32RM52700	52700

## Multiple Templates

This feature sets up multiple templates for OCR decoding. To do this, follow the procedure described in [OCR Template on page 274](#) (scan the [OCR Template](#) barcode, then barcodes corresponding to numbers and letters to form the template expression, then **End of Message**) for each template in the multiple template string, using a capital letter **X** as a separator between the templates.

For example, set the [OCR Template](#) as **99999XAAAAA** to decode OCR strings of either **12345** or **ABCDE**.

## Template Examples

Following are sample templates with descriptions of valid data for each definition.

### Field Definition Description

"M"99977 M followed by three digits and two optional digits.

"X"997777"X" X followed by two digits, four optional digits, and an X.

9959775599 Two digits followed by any character, a digit, two optional digits, any two characters, and two digits.

A55"- "999"- "99 A letter followed by two characters, a dash, three digits, a dash, and two digits.

33A" . "99 Two alphanumeric characters followed by a letter, a period, and two digits.

999992991 Five digits followed by an optional alpha, two digits, and an optional alphanumeric.

"PN98" Literal field - PN98

## OCR Check Digit Modulus

### Parameter # 688 (SSI # F1h B0h)

This option sets OCR module check digit calculation. The check digit is the last digit (in the right most position) in an OCR string and improves the accuracy of the collected data. The check digit is the end product of a calculation made on the incoming data. For check digit calculation, for example Modulus 10, alpha and numeric characters are assigned numeric weights (see [OCR Check Digit Multiplier on page 284](#)). The calculation is applied to the character weights and the resulting check digit is added to the end of the data. If the incoming data does not match the check digit, the data is considered corrupt.

The selected check digit option does not take effect until you set **OCR Check Digit Validation**.

To choose the Check Digit Modulus, such as 10 for modulo 10, scan the following barcode, then scan a three-digit number from 001 to 099 representing the check digit using the numeric keypad in the *Advanced Data Formatting Guide*. The default is 1.



OCR Check Digit

## OCR Check Digit Multiplier

### Parameter # 700 (SSI # F1h BCh)

This option sets OCR check digit multipliers for the character positions. For check digit validation, each character in scanned data has an equivalent weight used in the check digit calculation. DS36X8 OCR ships with the following weight equivalents:

0 = 0 A = 10 K = 20 U = 30

1 = 1 B = 11 L = 21 V = 31

2 = 2 C = 12 M = 22 W = 32

3 = 3 D = 13 N = 23 X = 33

4 = 4 E = 14 O = 24 Y = 34

5 = 5 F = 15 P = 25 Z = 35

6 = 6 G = 16 Q = 26 Space = 0

7 = 7 H = 17 R = 27

8 = 8 I = 18 S = 28

9 = 9 J = 19 T = 29

All other characters are equivalent to one (1).

You can define the multiplier string if it is different from the default.

121212121212 (default)

123456789A (for ISBN, Product Add Right to Left. See [OCR Check Digit Validation on page 286](#).)

For example:

ISBN 0 2 0 1 1 8 3 9 9 4

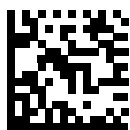
Multiplier 10 9 8 7 6 5 4 3 2 1

Product 0 18 0 7 6 40 12 27 18 4

Product add 0+ 18+ 0+ 7+ 6+ 40+ 12+ 27+ 18+ 4= 132

ISBN uses modulo 11 for its check digit. In this case, 132 is divisible by 11, so it passes the check digit.

To set the check digit multiplier, scan the following barcode, then scan numbers and letters to form the multiplier string from the alphanumeric keyboard in the *Advanced Data Formatting Guide*. Then scan **End of Message** in the *Advanced Data Formatting Guide*.



OCR Check Digit Multiplier



## OCR Check Digit Validation

### Parameter # 694 (SSI # F1h B6h)

Use **OCR Check Digit Validation** to protect against scanning errors by applying a check digit validation scheme. The following is a list of options.

#### None

No check digit validation, indicating no check digit is applied. This is the default.



\* No Check Digit  
(0)

#### Product Add Left to Right

Each character in the scanned data is assigned a numeric value (see [OCR Check Digit Multiplier on page 284](#)). Each digit representing a character in the scanned data is multiplied by its corresponding digit in the multiplier, and the sum of these products is computed. The check digit passes if this sum modulo Check Digit Modulus is zero.

Example:

Scanned data numeric value is 132456 (check digit is 6)

Check digit multiplier string is 123456

Digit 1 3 2 4 5 6

Multiplier 1 2 3 4 5 6

Product 1 6 6 16 25 36

Product add  $1+ 6+ 6+ 16+ 25+ 36= 90$

The Check Digit Modulus is 10. It passes because 90 is divisible by 10 (the remainder is zero).



Product Add Left to Right  
(3)

#### Product Add Right to Left

Each character in the scanned data is assigned a numeric value (see [OCR Check Digit Multiplier on page 284](#)). The check digit multiplier is reversed in order. Each value representing a character in the scanned data is

multiplied by its corresponding digit in the reversed multiplier, resulting in a product for each character in the scanned data. The sum of these products is computed. The check digit passes if this sum modulo Check Digit Modulus is zero.

Example:

Scanned data numeric value is 132459 (check digit is 9)

Check digit multiplier string is 123456

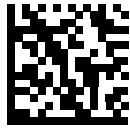
Digit 1 3 2 4 5 9

Multiplier 6 5 4 3 2 1

Product 6 15 8 12 10 9

Product add  $6+ 15+ 8+ 12+ 10+ 9= 60$

The Check Digit Modulus is 10. It passes because 60 is divisible by 10 (the remainder is 0).



**Product Add Right to Left  
(1)**

## Digit Add Left to Right

Each character in the scanned data is assigned a numeric value (see [OCR Check Digit Multiplier on page 284](#)). Each value representing a character in the scanned data is multiplied by its corresponding digit in the multiplier, resulting in a product for each character in the scanned data. The sum of each individual digit in all of the products is then calculated. The check digit passes if this sum modulo Check Digit Modulus is zero.

Example:

Scanned data numeric value is 132456 (check digit is 6)

Check digit multiplier string is 123456

Digit 1 3 2 4 5 6

Multiplier 1 2 3 4 5 6

Product 1 6 6 16 25 36

Digit add  $1+ 6+ 6+ 1+6+ 2+5+ 3+6= 36$

The Check Digit Modulus is 12. It passes because 36 is divisible by 12 (the remainder is 0).



**Digit Add Left to Right  
(4)**



## Digit Add Right to Left

Each character in the scanned data is assigned a numeric value (see [OCR Check Digit Multiplier on page 284](#)). The check digit multiplier is reversed in order. Each value representing a character in the scanned data is multiplied by its corresponding digit in the reversed multiplier, resulting in a product for each character in the scanned data. The sum of each individual digit in all of the products is then calculated. The check digit passes if this sum modulo Check Digit Modulus is zero.

Example:

Scanned data numeric value is 132456 (check digit is 6)

Check digit multiplier string is 123456

Digit 1 3 2 4 5 6

Multiplier 6 5 4 3 2 1

Product 6 15 8 12 10 6

Digit add  $6+ 1+5+ 8+ 1+2+ 1+0+ 6= 30$

The Check Digit Modulus is 10. It passes because 30 is divisible by 10 (the remainder is 0).



**Digit Add Right to Left  
(2)**

## Product Add Right to Left Simple Remainder

Each character in the scanned data is assigned a numeric value (see [OCR Check Digit Multiplier on page 284](#)). The check digit multiplier is reversed in order. Each value representing a character in the scanned data is multiplied by its corresponding digit in the reversed multiplier, resulting in a product for each character in the scanned data. The sum of these products **except for the check digit's product** is computed. The check digit passes if this sum modulo Check Digit Modulus is equal to the check digit's product.

Example:

Scanned data numeric value is 122456 (check digit is 6)

Check digit multiplier string is 123456

Digit 1 2 2 4 5 6

Multiplier 6 5 4 3 2 1

Product 6 10 8 12 10 6

Product add  $6+ 10+ 8+ 12+ 10= 466$

The Check Digit Modulus is 10. It passes because 46 divided by 10 leaves a remainder of 6.



**Product Add Right to Left Simple Remainder  
(5)**

## Digit Add Right To Left Simple Remainder

Each character in the scanned data is assigned a numeric value (see [OCR Check Digit Multiplier on page 284](#)). The check digit multiplier is reversed in order. Each value representing a character in the scanned data is multiplied by its corresponding digit in the reversed multiplier, resulting in a product for each character in the scanned data. The sum of each individual digit in all of the products **except for the check digit's product** is then calculated. The check digit passes if this sum modulo Check Digit Modulus is equal to the check digit's product.

Example:

Scanned data numeric value is 122459 (check digit is 6)

Check digit multiplier string is 123456

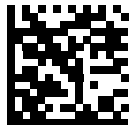
Digit 1 2 2 4 5 9

Multiplier 6 5 4 3 2 1

Product 6 10 8 12 10 9

Digit add  $6+ 1+0+ 8+ 1+2+ 1+0= 199$

The Check Digit Modulus is 10. It passes because 19 divided by 10 leaves a remainder of 9.



**Digit Add Right to Left Simple Remainder  
(6)**

## Health Industry - HIBCC43

This is the health industry module 43 check digit standard. The check digit is the modulus 43 sum of all the character values in a given message, and is printed as the last character in a given message.

Example:

Supplier Labeling Data Structure: + A 1 2 3 B J C 5 D 6 E 7 1

Sum of values:  $41+10+1+2+3+11+19+12+5+13+6+14+7+1 = 145$

Divide 145 by 43. The quotient is 3 with a remainder of 16. The check digit is the character corresponding to the value of the remainder (see Table 14), which in this example is 16, or **G**. The complete Supplier Labeling Data Structure, including the check digit, therefore is:

A 1 2 3 B J C 5 D 6 E 7 1 G

**Table 14** Table of Numeric Value Assignments for Computing HIBC LIC Data Format Check Digit

0 = 0	9 = 9	I = 18	R = 27	- = 36
1 = 1	A = 10	J = 19	S = 28	. = 37
2 = 2	B = 11	K = 20	T = 29	Space = 38
3 = 3	C = 12	L = 21	U = 30	\$ = 39
4 = 4	D = 13	M = 22	V = 31	/ = 40
5 = 5	E = 14	N = 23	W = 32	+ = 41
6 = 6	F = 15	O = 24	X = 33	% = 42
7 = 7	G = 16	P = 25	Y = 34	
8 = 8	H = 17	Q = 26	Z = 35	



Health Industry - HIBCC43  
(9)

## Inverse OCR

### Parameter # 856 (SSI # F2h 58h)

Inverse OCR is white or light words on a black or dark background. Select an option for decoding inverse OCR:

- **Regular Only** - decode regular OCR (black on white) strings only.
- **Inverse Only** - decode inverse OCR (white on black) strings only.
- **Autodiscriminate** - decodes both regular and inverse OCR strings.



\* Regular Only  
(0)



Inverse Only  
(1)



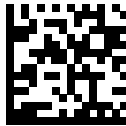
Autodiscriminate  
(2)

## OCR Redundancy

### Parameter # 1770 (SSI # F8h 06h EAh)

This option adjusts the number of times to decode an OCR text string before transmission. There are three levels of OCR decode redundancy. There is an inverse relationship between the redundancy level and OCR decoding aggressiveness. Increasing the level of the redundancy can reduce OCR scanning aggressiveness, so select only the level of redundancy necessary.

- **OCR Redundancy Level 1:** This default setting allows the scanner to operate in its most aggressive state while providing sufficient accuracy in decoding most in-spec OCR text strings.
- **OCR Redundancy Level 2:** This setting eliminates most misdecodes while maintaining reasonable aggressiveness.
- **OCR Redundancy Level 3:** Select this option with greater redundancy requirements if OCR Redundancy Level 2 fails to eliminate misdecodes.



\* OCR Redundancy Level 1  
(1)



OCR Redundancy Level 2  
(2)



OCR Redundancy Level 3  
(3)

# Maintenance and Troubleshooting

---

## Introduction

This chapter provides suggested RS5100 troubleshooting and maintenance.

---

## Maintenance

Cleaning the scan window is the basic maintenance required. A dirty window can affect scanning performance.

- Do not allow abrasive material to touch the window.
- Remove any dirt particles with a damp cloth.
- Wipe the window using a tissue moistened with ammonia/water.
- Do not spray water or other cleaning liquids directly into the window.

---

## Battery Safety Guidelines

- The area in which the RS5100 units are charged should be clear of debris and combustible materials or chemicals. Particular care should be taken where the device is charged in a non-commercial environment.
- Do not use incompatible batteries and chargers. If you have any questions about the compatibility of a battery or a charger, contact Zebra Support. See [Service Information on page 14](#) for contact information.
- Do not crush, puncture, or place a high degree of pressure on the battery.
- Follow battery usage, storage, and charging guidelines.
- Improper battery use may result in a fire, explosion, or other hazard.
- To charge the mobile device battery, the battery and charger temperatures must be between +32°F and +104°F (0°C and +40°C)
- Do not disassemble or open, crush, bend or deform, puncture, or shred.
- Severe impact from dropping any battery-operated device on a hard surface could cause the battery to overheat.
- Do not short circuit a battery or allow metallic or conductive objects to contact the battery terminals.
- Do not modify or remanufacture, attempt to insert foreign objects into the battery, immerse or expose to water or other liquids, or expose to fire, explosion, or other hazard.
- Do not leave or store the equipment in or near areas that might get very hot, such as in a parked vehicle or near a radiator or other heat source. Do not place battery into a microwave oven or dryer.

- Battery usage by children should be supervised.
- Please follow local regulations to promptly dispose of used re-chargeable batteries.
- Do not dispose of batteries in fire.
- Seek medical advice immediately if a battery has been swallowed.
- In the event of a battery leak, do not allow the liquid to come in contact with the skin or eyes. If contact has been made, wash the affected area with large amounts of water and seek medical advice.
- If you suspect damage to your equipment or battery, call Customer Support to arrange for inspection. See [Service Information on page 14](#) for contact information.

---

## Long Term Storage

When storing the RS5100 for a long period of time, it is recommended to remove the battery. When returning the RS5100 to everyday operation, install a fully charged battery.

---

## Cleaning Instructions



**CAUTION:** Always wear eye protection.

Read warning label on compressed air and alcohol product before using.

If you have to use any other solution for medical reasons please contact Zebra for more information.



**WARNING:** Avoid exposing this product to contact with hot oil or other flammable liquids. If such exposure occurs, unplug the device and clean the product immediately in accordance with these guidelines.

## Approved Cleanser Active Ingredients

100% of the active ingredients in any cleaner must consist of one or some combination of the following: isopropyl alcohol, or mild dish soap.

## Harmful Ingredients

The following chemicals are known to damage the plastics on the device and should not come in contact with the device: ammonia solutions, compounds of amines or ammonia; acetone; ketones; ethers; aromatic and chlorinated hydrocarbons; aqueous or alcoholic alkaline solutions; ethanolamine; toluene; trichloroethylene; benzene; carbolic acid, TB-lysoform, bleach products and hydrogen peroxide.

## Cleaning Instructions

Do not apply liquid directly to the device. Dampen a soft cloth or use pre-moistened wipes. Do not wrap the device in the cloth or wipe, but gently wipe the unit. Be careful not to let liquid pool around the display window or other places. Allow the unit to air dry before use.

## Special Cleaning Notes

Many vinyl gloves contain phthalate additives, which are often not recommended for medical use and are known to be harmful to the housing of the device. The device should not be handled while wearing vinyl gloves containing phthalates, or before hands are washed to remove contaminant residue after gloves are removed. If products

containing any of the harmful ingredients listed above are used prior to handling the device, such as hand sanitizer that contain ethanalamine, hands must be completely dry before handling the device to prevent damage to the plastics.

### Cleaning Materials Required

- Alcohol wipes
- Lens tissue
- Cotton tipped applicators
- Isopropyl alcohol
- Can of compressed air with a tube.

### Cleaning Frequency

The cleaning frequency is up to the customer's discretion due to the varied environments in which the WT6000 units are used. They may be cleaned as frequently as required. However when used in dirty environments it may be advisable to periodically clean the scanner exit window to ensure optimum scanning performance.

### Cleaning the RS5100

#### Housing

Using alcohol wipes, wipe the housing.

#### Exit Window

Wipe the exit window periodically with a lens tissue or other material suitable for cleaning eyeglasses.



**CAUTION:** Do not pour, spray, or spill any liquid on the RS5100.

#### Power Connector

1. Remove the battery from RS5100.
2. Dip the cotton portion of the cotton tipped applicator in isopropyl alcohol.
3. Rub the cotton portion of the cotton tipped applicator back-and-forth across the battery connector inside the battery compartment and the I/O connector on the top side of the RS5100. Do not leave any cotton residue on the connectors.
4. Repeat at least three times.
5. Use the cotton tipped applicator dipped in alcohol to remove any grease and dirt near the connector area.
6. Use a dry cotton tipped applicator and repeat steps 3 through 5.
7. Spray compressed air on the connector area by pointing the tube/nozzle about ½ inch away from the surface.



**CAUTION:** Do not point nozzle at yourself and others, ensure the nozzle or tube is away from your face.

8. Inspect the area for any grease or dirt, repeat if required.



### Cleaning Cradle Connectors

Use this procedure to clean the connectors on a cradle:

1. Remove power from the cradle.
2. Dip the cotton portion of the cotton tipped applicator in isopropyl alcohol.
3. Rub the cotton portion of the cotton tipped applicator along the pins of the connector. Slowly move the applicator back-and-forth from one side of the connector to the other. Do not let any cotton residue on the connector.
4. All sides of the connector should also be rubbed with the cotton tipped applicator.
5. Spray compressed air in the connector area by pointing the tube/nozzle about ½ inch away from the surface.



**CAUTION:** Do not pour, spray, or spill any liquid on the RS5100.

6. Ensure that there is no lint left by the cotton tipped applicator, remove lint if found.
7. If grease and other dirt can be found on other areas of the cradle, use lint free cloth and alcohol to remove.
8. Allow at least 10 to 30 minutes (depending on ambient temperature and humidity) for the alcohol to air dry before applying power to cradle.

If the temperature is low and humidity is high, longer drying time is required. Warm temperature and dry humidity requires less drying time.

### Cleaning the Finger Strap and Comfort Pad

It may be necessary to wash the finger strap and comfort pad when they become soiled.

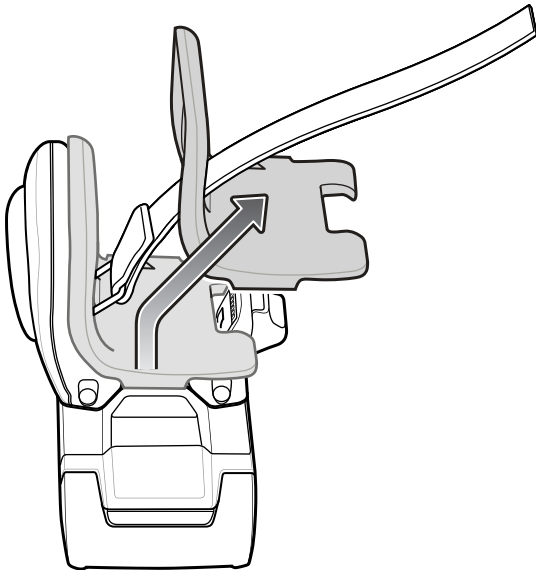
Remove the strap and comfort pads. See [Finger Strap Replacement](#) and [Comfort Pad Replacement](#). Hand wash in cold water with dish soap. Do not use bleach. Air dry. Do not use a hand dryer. Leave the comfort pad to air dry in a shaded area.

## Comfort Pad Replacement

To replace the Comfort Pad:

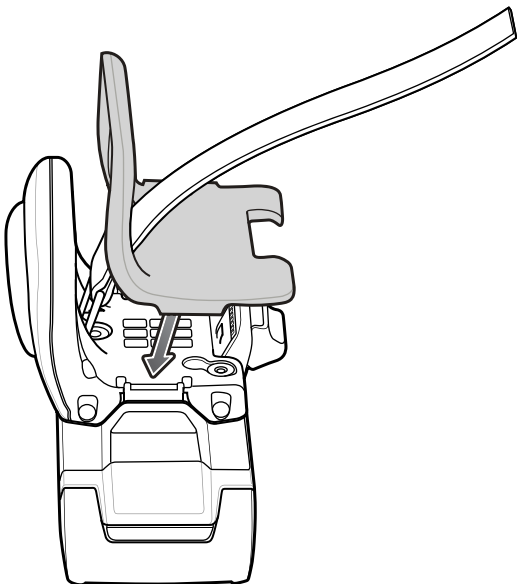
1. Slide the strap out of the buckle.
2. Remove the Comfort Pad from the RS5100.

**Figure 86** Removal of Comfort Pad



3. Position the Comfort Pad onto the RS5100 as shown.
4. Press the Comfort Pad onto the RS5100. When properly installed, the Comfort Pad locks into place.

**Figure 87** Installation of Comfort Pad



## Trigger Assembly Replacement

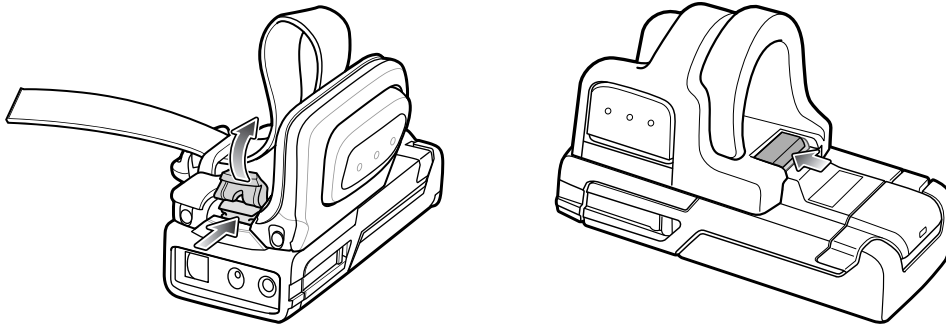
To replace the Single Trigger or Double Trigger Assembly:



**NOTE:** After installing a different type of trigger, reboot the RS5100 to recognize the new trigger.

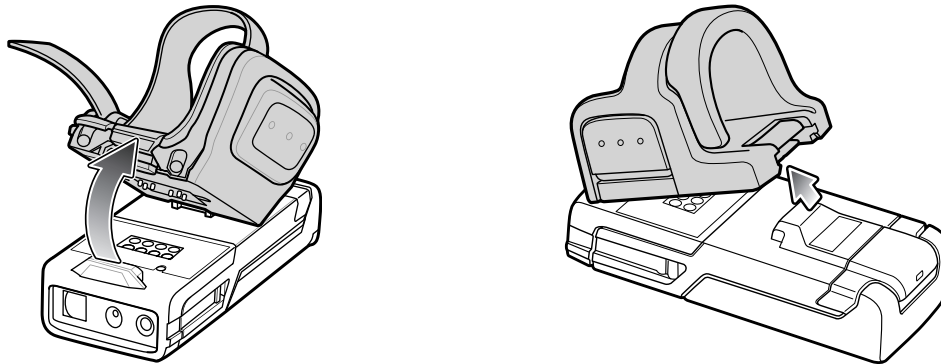
1. Push the Trigger Assembly latch in, while lifting the Trigger Assembly away from the RS5100.

**Figure 88** Push Trigger Assembly Latch In and Lift



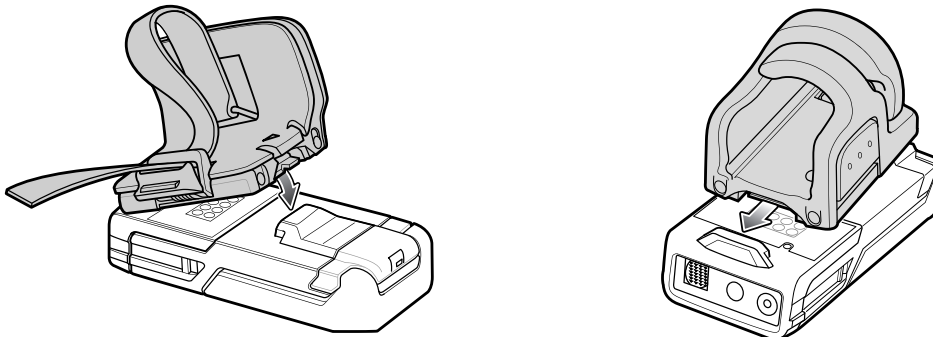
2. Lift the Trigger Assembly off of the RS5100.

**Figure 89** Lift Trigger Assembly Off RS5100



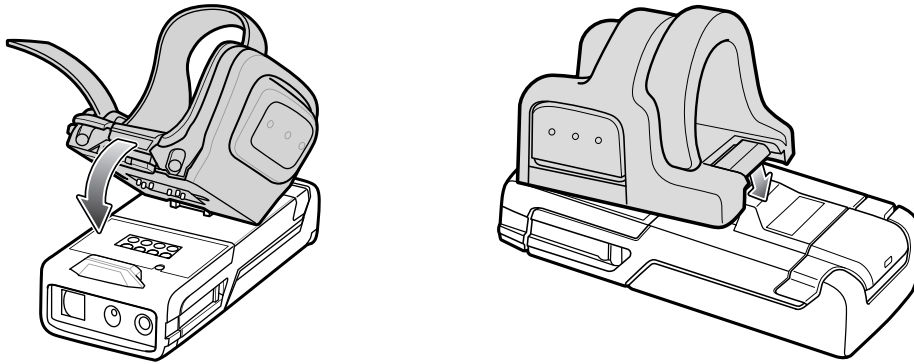
3. Position the Trigger Assembly to align with the back of the RS5100.

**Figure 90** Align Trigger Assembly



4. Lower the Trigger Assembly onto the housing and snap into place.

**Figure 91** Lower Trigger Assembly

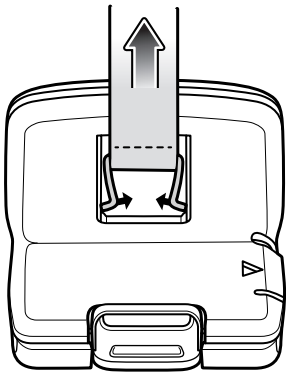


## Finger Strap Replacement

To replace the finger strap:

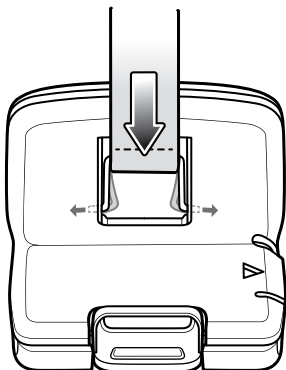
1. Use finger tip to press the strap release latch on the buckle.
2. Remove the Finger Strap from the buckle.
3. Push the Strap Pin in and pull the Finger Strap to remove the Strap Pin out of the Trigger Assembly.

**Figure 92** Remove Finger Strap from Trigger Assembly



4. Align the Strap Pin of a new Finger Strap with the slot in the Trigger Swivel Assembly.

**Figure 93** Finger Strap Pin Replacement



5. Guide the Strap Pin into the slots of the Trigger Swivel Assembly.

6. Pull up on the strap to snap the Strap Pin into the slots.
7. Slide the other end of the strap into the buckle.
8. Press the cam buckle closed.

## Troubleshooting

### RS5100

**Table 15** RS5100 Troubleshooting

Problem	Cause	Solution
Laser aiming pattern does not display when pressing the Scan Trigger.	Battery is not charged.	Replace or charge battery.
	Power is not applied to RS5100.	Replace or charge RS5100 battery.
	Scan application on the mobile computer is not functioning.	Restart the scanning application on the mobile computer.
	RS5100 does not respond.	Reset the RS5100 (See <a href="#">Resetting the RS5100 on page 26</a> ).
RS5100 does not decode a barcode.	Barcode is unreadable.	Verify that the barcode is not defective, i.e., smudged or damaged.
	Exit window is dirty.	Clean exit window with a lens tissue. Tissues for eyeglasses work well. Do not use tissues coated with lotion (see <a href="#">Cleaning the RS5100 on page 295</a> ).
	Barcode symbology is not supported or enabled.	See your system administrator.
	Bluetooth link is disconnected.	Reestablish Bluetooth connection (See <a href="#">Reconnecting on page 72</a> ).



**NOTE:** If after performing these checks the RS5100 still experiences problems, contact the distributor or call Zebra Support. See [Service Information on page 14](#).

## Cradles

**Table 16** RS5100 Troubleshooting

Problem	Cause	Solution
Device battery is not charging.	Device was removed from cradle or cradle was unplugged from AC power.	Ensure cradle is receiving power. Ensure device is seated correctly. Confirm main battery is charging. The battery fully charges in approximately four hours.
	Battery is faulty.	Verify that other batteries charge properly. If so, replace the faulty battery (see <a href="#">Install the Battery on page 21</a> ).
	The device is not fully seated in the cradle.	Remove and re-insert the device into the cradle, ensuring it is firmly seated.
	Ambient temperature of the cradle is too warm or too cold.	Move the cradle to an area where the ambient temperature is between 5 °C and 40 °C (41 °F and 105 °F).



**NOTE:** If after performing these checks the RS5100 still experiences problems, contact the distributor or call Zebra Support. See [Service Information on page 14](#).

# Specifications

## RS5100 Technical Specifications

The following tables summarize the RS5100's intended operating environment and general technical hardware specifications.

**Table 17** RS5100 Technical Specifications

Item	Description
<b>Physical Characteristics</b>	
Dimensions (H x W x L):	61 mm (2.67 in.) x 28 mm (1.10 in.) x 21 mm (0.83 in.)
Weight:	70 g / 2.47 oz.
Power	480 mAh standard capacity; 735 mAh extended; PowerPrecision+; Li-Ion Battery Pack
<b>Performance Characteristics</b>	
Optical Resolution:	1280 x 960 pixels
Roll:	360°
Pitch Angle:	± 60° from normal
Skew Tolerance:	± 60° from normal
Aiming Element:	SE4710: 610 nm LED SE4770: 655 nm Laser
Illumination Element	SE4710: 1 Hyper Red 660 nm LED SE4770: 1 Hyper Red 660 nm LED or 1 Warm-White LED
Field of View:	SE4710: Horizontal: 42°, Vertical: 28° SE4770: Horizontal: 48°, Vertical: 30°
SE4710 Typical Working Distance	See <a href="#">Decode Distances on page 308</a> .
SE4770 Typical Working Distance	See <a href="#">Decode Distances on page 308</a> .



## Specifications

**Table 17** RS5100 Technical Specifications (Continued)

Item	Description
Ambient Light Immunity (from total darkness):	Max 107,639 lux (direct sunlight)
Supported 1D Symbologies	Code 39, Code 128, Code 93, Codebar/NW7, Code 11, MSI, UPC/EAN, I 2 of 5, Korean 3 of 5, GSI DataBar, Base 32 (Italian Pharma).
Supported 2D Symbologies	PDF417, MicroPDF417, Composite Codes, TLC-39, Aztec, DataMatrix, MaxiCode, QR Code, Micro QR, Chinese Sensible (Han Xin), Postal Codes.
Supported OCR Symbologies	OCR-A, OCR-B
<b>User Interface</b>	
LED:	4 RGB LEDs located at the back side of the device (programmable).
Beeper:	Up to 85 dBA at 10 cm from the back of the device beeper port.
Restore Key:	User accessible for emergency warm boot and Bluetooth reconnect (after disconnect timeout).
Scan Triggering:	Manual ambidextrous trigger.
<b>User Environment</b>	
Operating Temperature:	-20°C (-4°F) to +50°C (+122°F) (operation with extended battery).
Storage Temperature:	-40°C (-40°F) to +60°C (+140°F) including battery -40°C (-40°F) to +70°C (+158°F) excluding battery
Humidity	5% to 95% (non-condensing).
Drop Specification:	6 ft./1.8 m multiple drops to concrete across operating temperature range.
Tumble Specification	1,000 tumbles @ 0.5 m/1.64 ft.
Sealing	IEC 60529: IP65
Vibration	Sine 5-2000 Hz, 4g peak, one hour per axis Random 20-2000 Hz, 6g RMS or 0.04g2/Hz, one hour per axis
Pairing	NFC; Tap to Pair
Electrostatic Discharge (ESD):	+/-15 kVdc air discharge +/-8 kVdc contact discharge
<b>Data Capture</b>	
Scanning Options	SE4710 or SE4770 standard range imaging engines.
<b>Peripherals and Accessories</b>	
Ring charger:	4-Slot RS5100 Charge Only Cradle 20-Slot RS5100 Charge Only Cradle
Battery charger:	8-Slot Battery Charger 40-Slot Battery Charger

**Table 17** RS5100 Technical Specifications (Continued)

Item	Description
Other:	Back of hand mount, lanyard, spare trigger mounts (Not all accessories available during initial release).
<b>Wireless PAN</b>	
Bluetooth	Class 1 and 2, Bluetooth v4.0 with Bluetooth Low Energy (BLE) Supporting profiles: Serial Port Profile (SPP), Human Interface Device Profile (HID), Service Discovery Application Profile (SDAP).
<b>Regulatory</b>	
Environmental Compliance:	RoHS Directive 2011/65/EU; Amendment 2015/863 REACH SVHC 1907/2006

## Cradle Technical Specifications

### 4-Slot Charge Only Cradle Technical Specifications

**Table 18** 4-Slot Charge Only Cradle Technical Specifications

Item	Description
Dimensions	Height: 87.97 mm (3.46 in.) Width: 97.52 mm (3.84 in.) Depth: 136.25 mm (5.36 in.)
Weight	433 g (15.27 oz.)
Input Voltage	12 VDC
Power Consumption	50 watts
Operating Temperature	5°C to 40°C (41°F to 105°F)
Storage Temperature	-40°C to 70°C (-40°F to 158°F)
Charging Temperature	10°C to 40°C (50°F to 105°F)
Humidity	5% to 95% non-condensing
Drop	75 cm (30 in.) drops to concrete at room temperature.
Electrostatic Discharge (ESD)	+/- 15 kV air discharge +/- 8 kV contact discharge

### 8-Slot Battery Charger Technical Specifications

**Table 19** 8-Slot Battery Charger Technical Specifications

Item	Description
Dimensions	Height: 83.64 mm (3.29 in.) Width: 97.52 mm (3.84 in.) Depth: 137.29 mm (5.4 in.)
Weight	486 g (17.14 oz.)
Input Voltage	12 VDC
Power Consumption	50 watts
Operating Temperature	5°C to 40°C (41°F to 105°F)
Storage Temperature	-40°C to 70°C (-40°F to 158°F)
Charging Temperature	10°C to 40°C (50°F to 105°F)
Humidity	5% to 95% non-condensing

**Table 19** 8-Slot Battery Charger Technical Specifications

Item	Description
Drop	75 cm (30 in.) drops to concrete at room temperature.
Electrostatic Discharge (ESD)	+/- 15 kV air discharge +/- 8 kV contact discharge

## Decode Distances

**Table 20** Decode Distances

Barcode Type	Symbol Density	SE4710 Typical Working Ranges		SE4770 Typical Working Ranges	
		Near	Far	Near	Far
Code 39	3 mil	N/A	N/A	7.6 cm./3.0 in.	14.7 cm./5.8 in.
	4 mil	8.4 cm./3.3 in.	22.4 cm./8.8 in.	N/A	N/A
	5 mil	5.08 cm./2.0 in.	34.3 cm./13.5 in.	N/A	N/A
	20 mil	5.08 cm./2.0 in. Field of view limited	76.2 cm./30.0 in.	4.1 cm./1.6 in.	91.7 cm./36.1 in.
Code 128	5 mil	7.1 cm./2.8 in.	20.8 cm/8.2 in.	5.8 cm./2.3 in.	24.9 cm./9.8 in.
	15 mil	N/A	N/A	6.1 cm./2.4 in.	70.6 cm./27.8 in.
PDF 417	5 mil	7.9 cm./3.1 in.	21.3 cm./8.4 in.	7.6 cm./3.0 in.	20.1 cm./7.9 in.
	6.67 mil	N/A	N/A	6.4 cm./2.5 in.	25.7 cm./10.1 in.
DataMatrix	10 mil	7.4 cm./2.9 in.	25.7 cm./10.1 in.	5.3 cm./2.1 in.	27.9 cm./11.0 in.
100% UPCA		4.6 cm./1.8 in. Field of view limited	66.0 cm./26.0 in.	4.1 cm./1.6 in.	63.2 cm./24.9 in.
QR	20 mil	N/A	N/A	2.8 cm./1.1 in.	44.5 cm./17.5 in.

# Standard Default Parameters

## Standard Default Parameters Table

**Table 21** Standard Default Parameters Table

Parameter	Parameter Number	Default	Page Number
<b>Bluetooth Communications</b>			
Bluetooth Communications Host Types		SSI Bluetooth Classic	
Discoverable Mode	610	General	<a href="#">65</a>
Wi-Fi Friendly Mode		Disable	<a href="#">68</a>
Wi-Fi Friendly Channel Exclusion		Use All Channels	<a href="#">69</a>
Radio Output Power	1324	Class 2	<a href="#">70</a>
Link Supervision Timeout	1698	2 Seconds	<a href="#">71</a>
HID Features for Apple iOS	1114	Disable	<a href="#">37</a>
HID Keyboard Keystroke Delay		No Delay (0 msec)	<a href="#">37</a>
CAPS Lock Override		Disable	<a href="#">39</a>
Ignore Unknown Characters		Enable	<a href="#">39</a>
Emulate Keypad		Disable	<a href="#">40</a>
Fast HID Keyboard	1361	Enable	<a href="#">41</a>
Quick Keypad Emulation	1362	Enable	<a href="#">42</a>
Keyboard FN1 Substitution		Disable	<a href="#">42</a>
Function Key Mapping		Disable	<a href="#">43</a>
Simulated Caps Lock		Disable	<a href="#">43</a>
Convert Case		No Case Conversion	<a href="#">44</a>
Beep on Reconnect Attempt	559	Disable	<a href="#">73</a>
Reconnect Attempt Interval	558	30 sec	<a href="#">73</a>

## Standard Default Parameters

**Table 21** Standard Default Parameters Table (Continued)

Parameter	Parameter Number	Default	Page Number
Auto-reconnect	604	Auto-reconnect Immediately	74
Beep on Insertion	288	Enable	118
Beep on <BEL>	150	Enable	59
Toggle Pairing	1322	Disable	75
Force Pairing Save	795	Enable	76
Auto Un-Pairing	1708	Disable	76
Batch Mode	544	Normal (Do Not Batch Data)	78
PIN Code (Set and Store)	552	12345	66
Variable Pin Code	608	Static (Default PIN code is 12345)	67
Bluetooth Security Levels	1393	Low	67
<b>User Preferences</b>			
Set Default Parameter		Set Defaults	116
Parameter Barcode Scanning	ECh	Enabled	117
Beep After Good Decode	38h	Enabled	118
Beep on Insertion	288	Enabled	118
Beeper Tone	91h	High	120
Beeper Volume	8Ch	High	119
Beeper Duration	F1 74h	Medium	121
Suppress Power Up Beeps	721	Do Not Suppress	121
Low Battery Indication	779	Enable	122
Hand-Held Trigger Mode	138	Level	123
Hand-Held Decode Aiming Pattern	306	Enable	124
Picklist Mode	402	Disabled Always	125
Continuous Barcode Read	649	Disable	126
Unique Barcode Reporting	723	Enable	127
Decode Session Timeout	136	9.9 Sec	128
Timeout Between Decodes, Same Symbol	137	0.5 Sec	129
Timeout Between Decodes, Different Symbols	144	0.1 sec	130

## Standard Default Parameters

**Table 21** Standard Default Parameters Table (Continued)

Parameter	Parameter Number	Default	Page Number
Fuzzy 1D Processing	514	Enable	130
Decode Mirror Images (Data Matrix Only)	537	Auto	131
PDF Prioritization	719	Disable	133
PDF Prioritization Timeout	720	200 ms	134
Decoding Illumination	298	Enable	135
Motion Tolerance	858	Less Motion Tolerance	136
<b>Miscellaneous Options</b>			
Add an Enter Key	N/A	N/A	136
Transmit Code ID Character	45	None	136
Prefix Value	99, 105	7013 <CR><LF>	137
Suffix 1 Value	98, 104	7013 <CR><LF>	137
Suffix 2 Value	100, 106		
Scan Data Transmission Format	235	Data as is	138
FN1 Substitution Values	103, 109	7013 <CR><LF>	140
Transmit "No Read" Message	94	Disable	141
Picklist Mode	F0h 92h	Disabled	125
Fuzzy 1D Processing	F1h 02h	Enabled	130
Decoding Illumination	F0h, 2Ah	Enabled	135
<b>Symbologies</b>			
Enable/Disable All Code Types			151
<b>UPC/EAN</b>			
UPC-A	1	Enable	152
UPC-E	2	Enable	152
UPC-E1	12	Disable	153
EAN-8/JAN 8	4	Enable	153
EAN-13/JAN 13	3	Enable	154
Bookland EAN	83	Disable	154
Decode UPC/EAN/JAN Supplementals (2 and 5 digits)	16	Ignore	155



## Standard Default Parameters

**Table 21** Standard Default Parameters Table (Continued)

Parameter	Parameter Number	Default	Page Number
User-Programmable Supplementals		000	158
Supplemental 1:	579		
Supplemental 2:	580		
UPC/EAN/JAN Supplemental Redundancy	80	10	158
Decode UPC/EAN/JAN Supplemental AIM ID	672	Combined	159
UPC Reduced Quiet Zone	1289	Disable	160
Transmit UPC-A Check Digit	40	Enable	160
Transmit UPC-E Check Digit	41	Enable	161
Transmit UPC-E1 Check Digit	42	Enable	161
UPC-A Preamble	34	System Character	162
UPC-E Preamble	35	System Character	163
UPC-E1 Preamble	36	System Character	164
Convert UPC-E to A	37	Disable	165
Convert UPC-E1 to A	38	Disable	165
EAN-8/JAN-8 Extend	39	Disable	166
Bookland ISBN Format	576	ISBN-10	167
UCC Coupon Extended Code	85	Disable	168
Coupon Report	730	New Coupon Format	169
ISSN EAN	617	Disable	170
<b>Code 128</b>			
Code 128	8	Enable	171
Set Length(s) for Code 128	209, 210	1 to 55	172
GS1-128 (formerly UCC/EAN-128)	14	Enable	174
ISBT 128	84	Enable	174
ISBT Concatenation	577	Autodiscriminate	175
Check ISBT Table	578	Enable	176
ISBT Concatenation Redundancy	223	10	176
Code 128 Security Level	751	Security Level 1	177
Code 128 Reduced Quiet Zone	1208	Disable	178

## Standard Default Parameters

**Table 21** Standard Default Parameters Table (Continued)

Parameter	Parameter Number	Default	Page Number
Ignore Code 128 <FNC4>	1254	Disable	178
Code 128 Exclusive	Param 673	Disable	179
<b>Code 39</b>			
Code 39	0	Enable	180
Trioptic Code 39	13	Disable	180
Convert Code 39 to Code 32 (Italian Pharmacy Code)	86	Disable	181
Code 32 Prefix	231	Disable	182
Set Length(s) for Code 39	18, 19	1 to 55	183
Code 39 Check Digit Verification	48	Disable	184
Transmit Code 39 Check Digit	43	Disable	184
Code 39 Full ASCII Conversion	17	Disable	185
Code 39 Security Level	750	Security Level 1	186
Code 39 Reduced Quiet Zone	1209	Disable	187
Code 39 Buffering - Scan and Store	113	Disable	187
<b>Code 93</b>			
Code 93	9	Enable	190
Set Length(s) for Code 93	26, 27	1 to 55	190
<b>Code 11</b>			
Code 11	10	Disable	192
Set Lengths for Code 11	28, 29	4 to 55	192
Code 11 Check Digit Verification	52	Disable	194
Transmit Code 11 Check Digit(s)	47	Disable	195
<b>Interleaved 2 of 5 (ITF)</b>			
Interleaved 2 of 5 (ITF)	6	Disable	196
Set Lengths for I 2 of 5	22, 23	6 to 55	197
I 2 of 5 Check Digit Verification	49	Disable	199
Transmit I 2 of 5 Check Digit	44	Disable	200
Convert I 2 of 5 to EAN 13	82	Disable	200

## Standard Default Parameters

**Table 21** Standard Default Parameters Table (Continued)

Parameter	Parameter Number	Default	Page Number
I 2 of 5 Security Level	1121	Security Level 1	<a href="#">201</a>
I 2 of 5 Reduced Quiet Zone	1210	Disable	<a href="#">202</a>
Discrete 2 of 5 (DTF)			
Discrete 2 of 5	5	Disable	<a href="#">203</a>
Set Length(s) for D 2 of 5	20, 21	1 to 55	<a href="#">204</a>
Codabar (NW - 7)			
Codabar	7	Enable	<a href="#">206</a>
Set Lengths for Codabar	24, 25	4 to 55	<a href="#">206</a>
CLSI Editing	54	Disable	<a href="#">208</a>
NOTIS Editing	55	Disable	<a href="#">208</a>
Codabar Upper or Lower Case Start/ Stop Characters Detection	855	Upper Case	<a href="#">209</a>
MSI			
MSI	11	Disable	<a href="#">210</a>
Set Length(s) for MSI	30, 31	4 to 55	<a href="#">210</a>
MSI Check Digits	50	One	<a href="#">212</a>
Transmit MSI Check Digit	46	Disable	<a href="#">212</a>
MSI Check Digit Algorithm	51	Mod 10/Mod 10	<a href="#">214</a>
Chinese 2 of 5			
Chinese 2 of 5	408	Disable	<a href="#">215</a>
Matrix 2 of 5			
Matrix 2 of 5	618	Disable	<a href="#">216</a>
Matrix 2 of 5 Lengths	619 620	4 to 55	<a href="#">216</a>
Matrix 2 of 5 Check Digit	622	Disable	<a href="#">218</a>
Transmit Matrix 2 of 5 Check Digit	623	Disable	<a href="#">218</a>
Korean 3 of 5			
Korean 3 of 5	581	Disable	<a href="#">219</a>
Inverse 1D	586	Regular	<a href="#">220</a>

## Standard Default Parameters

**Table 21** Standard Default Parameters Table (Continued)

Parameter	Parameter Number	Default	Page Number
GS1 DataBar			
GS1 DataBar-14	338	Enable	<a href="#">221</a>
GS1 DataBar Limited	339	Enable	<a href="#">221</a>
GS1 DataBar Expanded	340	Enable	<a href="#">222</a>
Convert GS1 DataBar to UPC/EAN	397	Disable	<a href="#">222</a>
GS1 DataBar Limited Security Level	728	Level 3	<a href="#">223</a>
Composite			
Composite CC-C	341	Disable	<a href="#">224</a>
Composite CC-A/B	342	Disable	<a href="#">224</a>
Composite TLC-39	371	Disable	<a href="#">225</a>
UPC Composite Mode	344	UPC Never Linked	<a href="#">226</a>
Composite Beep Mode	398	Beep As Each Code Type is Decoded	<a href="#">227</a>
GS1-128 Emulation Mode for UCC/EAN Composite Codes	427	Disable	<a href="#">227</a>
2D Symbolologies			
PDF417	15	Enable	<a href="#">228</a>
MicroPDF417	227	Disable	<a href="#">228</a>
Code 128 Emulation	123	Disable	<a href="#">229</a>
Data Matrix	292	Enable	<a href="#">230</a>
GS1 Data Matrix	1336	Disable	<a href="#">230</a>
Data Matrix Inverse	588	Inverse Autodetect	<a href="#">231</a>
Maxicode	294	Disable	<a href="#">231</a>
QR Code	293	Enable	<a href="#">232</a>
GS1 QR	1343	Disable	<a href="#">232</a>
MicroQR	573	Enable	<a href="#">233</a>
Aztec	574	Enable	<a href="#">233</a>
Aztec Inverse	589	Inverse Autodetect	<a href="#">233</a>
Han Xin	1167	Disable	<a href="#">234</a>
Han Xin Inverse	1168	Regular	<a href="#">234</a>

## Standard Default Parameters

**Table 21** Standard Default Parameters Table (Continued)

Parameter	Parameter Number	Default	Page Number
<b>Postal Codes</b>			
US Postnet	89	Disable	<a href="#">240</a>
US Planet	90	Disable	<a href="#">240</a>
Transmit US Postal Check Digit	95	Enable	<a href="#">241</a>
UK Postal	91	Disable	<a href="#">241</a>
Transmit UK Postal Check Digit	96	Enable	<a href="#">242</a>
Japan Postal	290	Disable	<a href="#">242</a>
Australia Post	291	Disable	<a href="#">243</a>
Australia Post Format	718	Autodiscriminate	<a href="#">244</a>
Netherlands KIX Code	326	Disable	<a href="#">245</a>
USPS 4CB/One Code/Intelligent Mail	592	Disable	<a href="#">245</a>
UPU FICS Postal	611	Disable	<a href="#">246</a>
Mailmark	1337	Disable	<a href="#">246</a>
Canada Post	92	Disable	<a href="#">247</a>
<b>Symbology-Specific Security Levels</b>			
Redundancy Level	78	1	<a href="#">248</a>
Security Level	77	1	<a href="#">250</a>
1D Quiet Zone Level	1288	1	<a href="#">251</a>
Intercharacter Gap Size	381	Normal	<a href="#">252</a>
Report Version			<a href="#">252</a>
<b>Macro PDF</b>			
Flush Macro PDF Buffer	N/A	N/A	<a href="#">253</a>
Abort Macro PDF Entry	N/A	N/A	<a href="#">253</a>
<b>OCR Programming Parameters</b>			
OCR-A	680	Disable	<a href="#">260</a>
OCR-A Variant	684	Full ASCII	<a href="#">261</a>
OCR-B	681	Disable	<a href="#">263</a>
OCR-B Variant	685	Full ASCII	<a href="#">264</a>
MICR E13B	682	Disable	<a href="#">268</a>

## Standard Default Parameters

**Table 21** Standard Default Parameters Table (Continued)

Parameter	Parameter Number	Default	Page Number
US Currency	683	Disable	<a href="#">269</a>
OCR Orientation	687	0°	<a href="#">269</a>
OCR Lines	691	1	<a href="#">271</a>
OCR Minimum Characters	689	3	<a href="#">271</a>
OCR Maximum Characters	690	100	<a href="#">272</a>
OCR Subset	686	Selected font variant	<a href="#">272</a>
OCR Quiet Zone	695	50	<a href="#">273</a>
OCR Template	547	54R	<a href="#">274</a>
OCR Check Digit Modulus	688	1	<a href="#">283</a>
OCR Check Digit Multiplier	700	121212121212	<a href="#">284</a>
OCR Check Digit Validation	694	None	<a href="#">286</a>
Inverse OCR	856	Regular	<a href="#">291</a>

# Programming Reference

## Symbol Code Identifiers

Table 22 Symbol Code Characters

Code Character	Code Type
A	UPC-A, UPC-E, UPC-E1, EAN-8, EAN-13
B	Code 39, Code 32
C	Codabar
D	Code 128
E	Code 93
F	Interleaved 2 of 5
G	Discrete 2 of 5, or Discrete 2 of 5 IATA
H	Code 11
J	MSI
K	GS1-128
L	Bookland EAN
M	Trioptic Code 39
N	Coupon Code
R	GS1 DataBar Family
T	UCC Composite, TLC 39
X	PDF417, Macro PDF417, Micro PDF417
z	Aztec, Aztec Rune
P00	Data Matrix
P01	QR Code, MicroQR
P02	Maxicode
P03	US Postnet

**Table 22** Symbol Code Characters (Continued)

Code Character	Code Type
P04	US Planet
P05	Japan Postal
P06	UK Postal
P08	Netherlands KIX Code
P09	Australian Postal
P0A	USPS 4CB/One Code/Intelligent Mail
P0B	UPU FICS Postal

## AIM Code Identifiers

Each AIM Code Identifier contains the three-character string **jcm** where:

- j = Flag Character (ASCII 93)
- c = Code Character (see [Table 23](#))
- m = Modifier Character (see [Table 24](#))

**Table 23** Aim Code Characters

Code Character	Code Type
A	Code 39, Code 39 Full ASCII, Code 32
C	Code 128, Coupon (Code 128 portion)
d	Data Matrix
E	UPC/EAN, Coupon (UPC portion)
e	GS1 DataBar Family
F	Codabar
G	Code 93
H	Code 11
I	Interleaved 2 of 5
L	PDF417, Macro PDF417, Micro PDF417
M	MSI
Q	QR Code, MicroQR
S	Discrete 2 of 5, IATA 2 of 5
U	Maxicode



**Table 23** Aim Code Characters (Continued)

Code Character	Code Type
z	Aztec, Aztec Rune
X	Bookland EAN, Trioptic Code 39, US Postnet, US Planet, UK Postal, Japan Postal, Australian Postal, Netherlands KIX Code, USPS 4CB/One Code/Intelligent Mail, UPU FICS Postal

The modifier character is the sum of the applicable option values based on [Table 24](#).

**Table 24** Modifier Characters

Code Type	Option Value	Option
<b>Code 39</b>	0	No check character or Full ASCII processing.
	1	Reader has checked one check character.
	3	Reader has checked and stripped check character.
	4	Reader has performed Full ASCII character conversion.
	5	Reader has performed Full ASCII character conversion and checked one check character.
	7	Reader has performed Full ASCII character conversion and checked and stripped check character.
	Example: A Full ASCII barcode with check character W, <b>A+I+MI+DW</b> , is transmitted as <b>J</b> A7AIMID where 7 = (3+4).	
<b>Trioptic Code 39</b>	0	No option specified at this time. Always transmit 0.
	Example: A Trioptic barcode 412356 is transmitted as <b>J</b> X0412356	
<b>Code 128</b>	0	Standard data packet, no Function code 1 in first symbol position.
	1	Function code 1 in first symbol character position.
	2	Function code 1 in second symbol character position.
	Example: A Code (EAN) 128 barcode with Function 1 character <sup>FNC1</sup> in the first position, AIMID is transmitted as <b>J</b> C1AIMID	
<b>I 2 of 5</b>	0	No check digit processing.
	1	Reader has validated check digit.
	3	Reader has validated and stripped check digit.
	Example: An I 2 of 5 barcode without check digit, 4123, is transmitted as <b>J</b> I04123	
<b>Codabar</b>	0	No check digit processing.
	1	Reader has checked check digit.
	3	Reader has stripped check digit before transmission.
	Example: A Codabar barcode without check digit, 4123, is transmitted as <b>J</b> F04123	

**Table 24** Modifier Characters (Continued)

Code Type	Option Value	Option
<b>Code 93</b>	0	No options specified at this time. Always transmit 0.
	Example: A Code 93 barcode 012345678905 is transmitted as <b>JG00</b> 12345678905	
<b>MSI</b>	0	Check digits are sent.
	1	No check digit is sent.
	Example: An MSI barcode 4123, with a single check digit checked, is transmitted as <b>JM1</b> 4123	
<b>D 2 of 5</b>	0	No options specified at this time. Always transmit 0.
	Example: A D 2 of 5 barcode 4123, is transmitted as <b>JS0</b> 4123	
<b>UPC/EAN</b>	0	Standard data packet in full EAN format, i.e. 13 digits for UPC-A, UPC-E, and EAN-13 (not including supplemental data).
	1	Two digit supplemental data only.
	2	Five digit supplemental data only.
	3	Combined data packet comprising 13 digits from EAN-13, UPC-A or UPC-E symbol and 2 or 5 digits from supplemental symbol.
	4	EAN-8 data packet.
	Example: A UPC-A barcode 012345678905 is transmitted as <b>JE000</b> 12345678905	
<b>Bookland EAN</b>	0	No options specified at this time. Always transmit 0.
	Example: A Bookland EAN barcode 123456789X is transmitted as <b>JX0</b> 123456789X	
<b>Code 11</b>	0	Single check digit
	1	Two check digits
	3	Check characters validated but not transmitted.
<b>GS1 DataBar Family</b>		No option specified at this time. Always transmit 0. GS1 DataBar-14 and GS1 DataBar Limited transmit with an Application Identifier "01". Note: In GS1-128 emulation mode, GS1 DataBar is transmitted using Code 128 rules (i.e., J C1).
	Example: A GS1 DataBar-14 barcode 100123456788902 is transmitted as <b>Je00</b> 1100123456788902.	

**Table 24** Modifier Characters (Continued)

Code Type	Option Value	Option
<b>EAN.UCC Composites (GS1 DataBar, GS1-128, 2D portion of UPC composite)</b>		Native mode transmission. Note: UPC portion of composite is transmitted using UPC rules.
	0	Standard data packet.
	1	Data packet containing the data following an encoded symbol separator character.
	2	Data packet containing the data following an escape mechanism character. The data packet does not support the ECI protocol.
	3	Data packet containing the data following an escape mechanism character. The data packet supports the ECI protocol.
		GS1-128 emulation Note: UPC portion of composite is transmitted using UPC rules.
	1	Data packet is a GS1-128 symbol (i.e., data is preceded with ]JC1).
<b>PDF417, Micro PDF417</b>	0	Reader set to conform to protocol defined in 1994 PDF417 symbology specifications. <b>Note:</b> When this option is transmitted, the receiver cannot reliably determine whether ECIs have been invoked or whether data byte 92 <sub>DEC</sub> has been doubled in transmission.
	1	Reader set to follow the ECI protocol (Extended Channel Interpretation). All data characters 92 <sub>DEC</sub> are doubled.
	2	Reader set for Basic Channel operation (no escape character transmission protocol). Data characters 92 <sub>DEC</sub> are not doubled. <b>Note:</b> When decoders are set to this mode, unbuffered Macro symbols and symbols requiring the decoder to convey ECI escape sequences cannot be transmitted.
	3	The barcode contains a GS1-128 symbol, and the first codeword is 903-907, 912, 914, 915.
	4	The barcode contains a GS1-128 symbol, and the first codeword is in the range 908-909.
	5	The barcode contains a GS1-128 symbol, and the first codeword is in the range 910-911.
	Example: A PDF417 barcode ABCD, with no transmission protocol enabled, is transmitted as ]L2ABCD.	
<b>Data Matrix</b>	0	ECC 000-140, not supported.
	1	ECC 200.
	2	ECC 200, FNC1 in first or fifth position.
	3	ECC 200, FNC1 in second or sixth position.
	4	ECC 200, ECI protocol implemented.
	5	ECC 200, FNC1 in first or fifth position, ECI protocol implemented.
	6	ECC 200, FNC1 in second or sixth position, ECI protocol implemented.

**Table 24** Modifier Characters (Continued)

Code Type	Option Value	Option
<b>MaxiCode</b>	0	Symbol in Mode 4 or 5.
	1	Symbol in Mode 2 or 3.
	2	Symbol in Mode 4 or 5, ECI protocol implemented.
	3	Symbol in Mode 2 or 3, ECI protocol implemented in secondary message.
<b>QR Code</b>	0	Model 1 symbol.
	1	Model 2 / MicroQR symbol, ECI protocol not implemented.
	2	Model 2 symbol, ECI protocol implemented.
	3	Model 2 symbol, ECI protocol not implemented, FNC1 implied in first position.
	4	Model 2 symbol, ECI protocol implemented, FNC1 implied in first position.
	5	Model 2 symbol, ECI protocol not implemented, FNC1 implied in second position.
	6	Model 2 symbol, ECI protocol implemented, FNC1 implied in second position.
<b>Aztec</b>	0	Aztec symbol.
	C	Aztec Rune symbol.

# Alphanumeric and Numeric Barcodes

---

## Numeric Barcodes

For parameters requiring specific numeric values, scan the appropriately numbered barcode(s).



---

## Numeric Barcodes (continued)



---

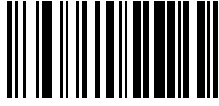
## Cancel

To correct an error or change a selection, scan the barcode below.



## Alphanumeric Barcodes

---



Space



#



\$



%

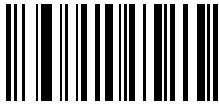
## Alphanumeric Keyboard (continued)



\*



+



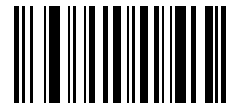
-



.



/



!



## Alphanumeric Keyboard (continued)



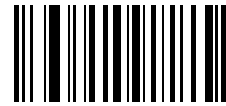
“



&



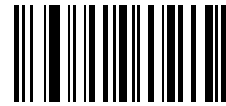
\$



(



)



:

## Alphanumeric Keyboard (continued)



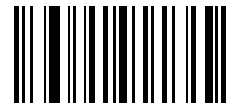
;



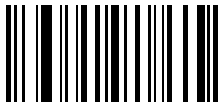
<



=



>

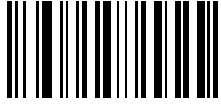


?



@

## Alphanumeric Keyboard (continued)



[



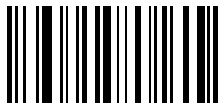
\



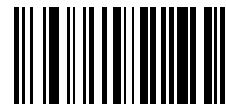
]



^



-



,

## Alphanumeric Keyboard (continued)



**NOTE:** The barcodes that follow should not be confused with those on the numeric keypad.



0



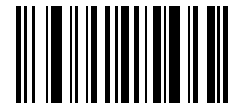
1



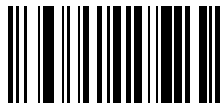
2



3



4

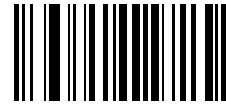


5

## Alphanumeric Keyboard (continued)



6



7



8



9



End of Message



Cancel

## Alphanumeric Keyboard (continued)



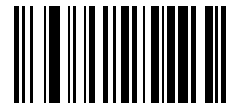
A



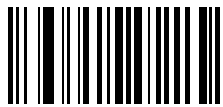
B



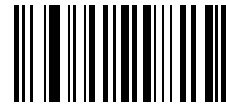
C



D



E

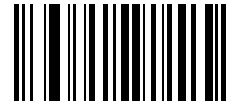


F

## Alphanumeric Keyboard (continued)



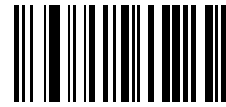
G



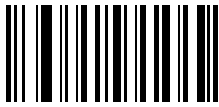
H



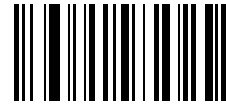
I



J



K

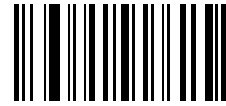


L

## Alphanumeric Keyboard (continued)



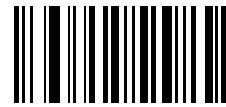
M



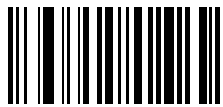
N



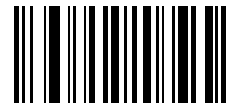
O



P



Q



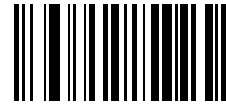
R



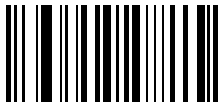
## Alphanumeric Keyboard (continued)



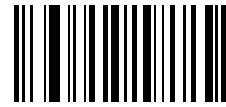
S



T



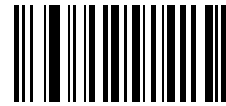
U



V



W



X

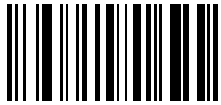
## Alphanumeric Keyboard (continued)



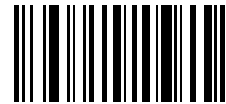
Y



Z



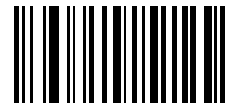
a



b



c

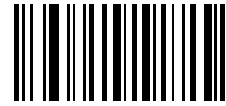


d

## Alphanumeric Keyboard (continued)



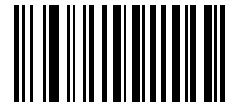
e



f



g



h



i

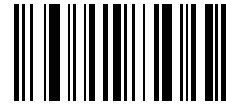


j

## Alphanumeric Keyboard (continued)



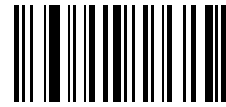
k



l



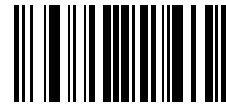
m



n

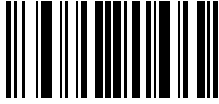


o



p

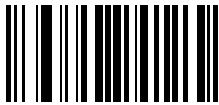
## Alphanumeric Keyboard (continued)



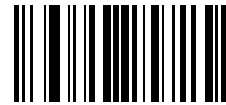
q



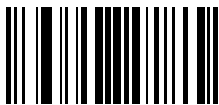
r



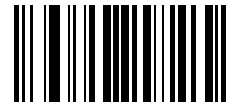
s



t

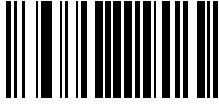


u

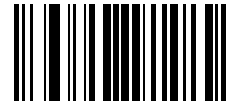


v

## Alphanumeric Keyboard (continued)



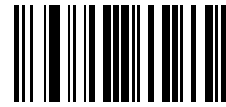
w



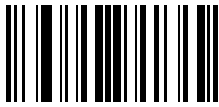
x



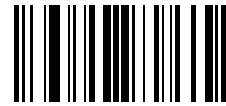
y



z



{



|

---

## Alphanumeric Keyboard (continued)



}



~

# Sample Barcodes

---

## Code 39



---

## UPC/EAN

### UPC-A, 100%



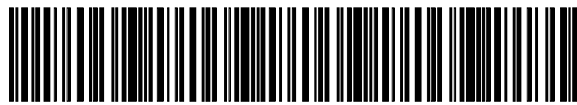


### EAN-13, 100%



---

### Code 128



---

12345678901234567890123456789012345678901234

### Interleaved 2 of 5



---

### GS1 DataBar-14



NOTE: DataBar-14 must be enabled to read the barcode below.



7612341562341

---

**PDF417**



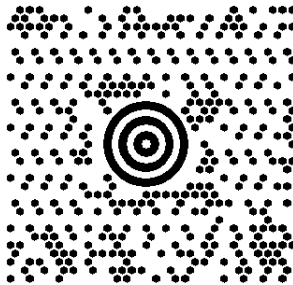
---

**Data Matrix**



---

**Maxicode**



---

**QR Code**



---

**US Postnet**



---

**UK Postal**



# Country Codes

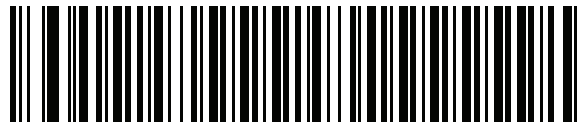
---

## Introduction

This chapter provides instructions for configuring the keyboard when the RS5100 is operating in Bluetooth HID mode.

To select a code page for the country keyboard type, see [Country Keyboard Types \(Country Codes\)](#).

Throughout the programming barcode menus, default values are indicated with asterisks (\*).



\*Indicates Default — \*US English (North American) — Feature/Option

## Country Keyboard Types (Country Codes)

Scan the barcode corresponding to the keyboard type. This setting applies only to the Bluetooth Keyboard (HID) device.

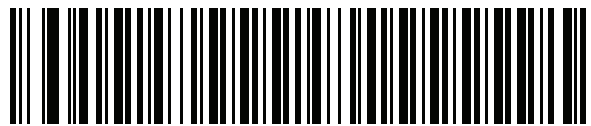


**NOTE:** For best results when using international keyboards, enable [Quick Keypad Emulation on page 42](#).

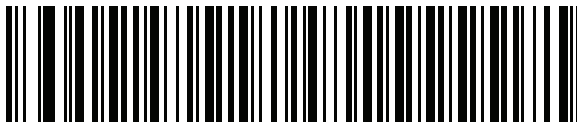


**IMPORTANT:** Some country keyboard barcode types are specific to certain Windows Operating Systems (i.e., XP, and Win 7 or higher). Barcodes requiring a specific Windows OS are noted so in their barcode captions.

Use the **French International** barcode for Belgian French keyboards.



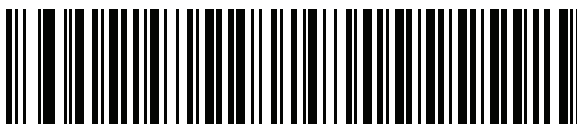
**\*US English (North American)**



**US English (Mac)**



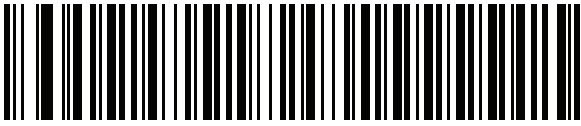
**Albanian**



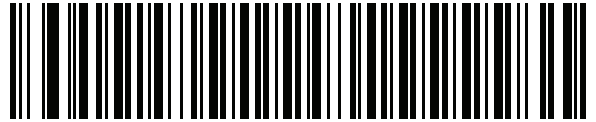
**Arabic (101)**



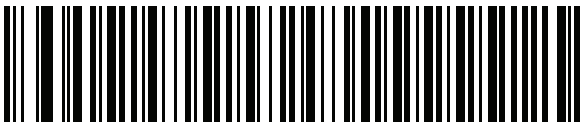
**Arabic (102)**



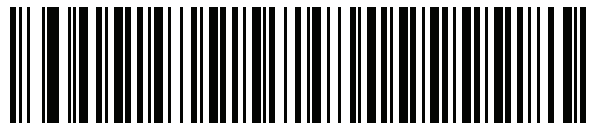
**Arabic (102) AZERTY**



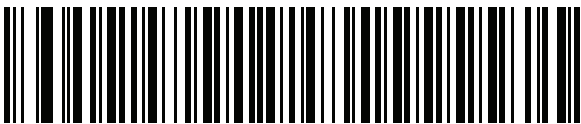
**Azeri (Latin)**



**Azeri (Cyrillic)**



**Belarusian**



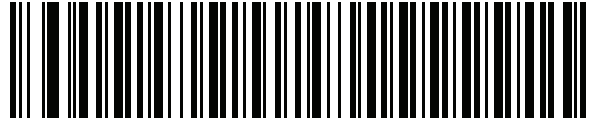
**Bosnian (Latin)**



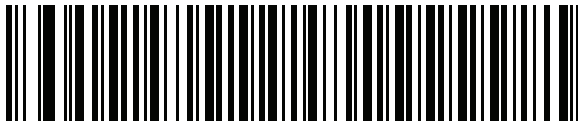
**Bosnian (Cyrillic)**



**Bulgarian (Latin)**



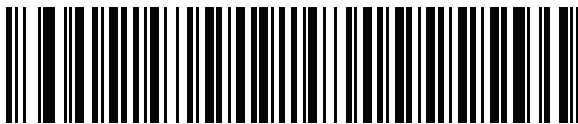
**Bulgarian Cyrillic (Typewriter)  
(Bulgarian -Windows XP  
Typewriter - Win 7 or higher)**



**Canadian French Win7**



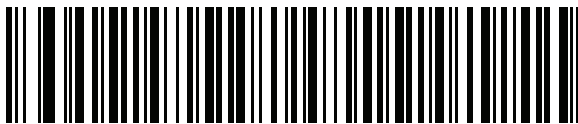
**Canadian French (Legacy)**



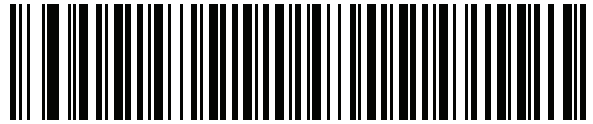
**Canadian Multilingual Standard**



**Chinese (ASCII)**

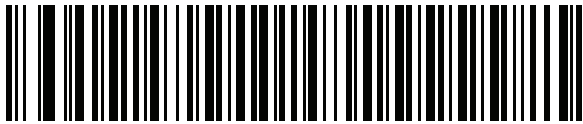


**Chinese (Simplified)\***



**Chinese (Traditional)\***

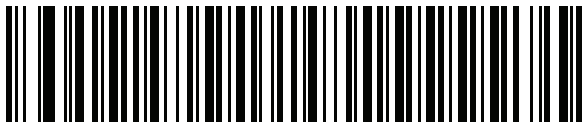
\*For CJK keyboard types, see [CKJ Decode Control](#).



**Croatian**



**Czech**



**Czech (Programmer)**



**Czech (QWERTY)**

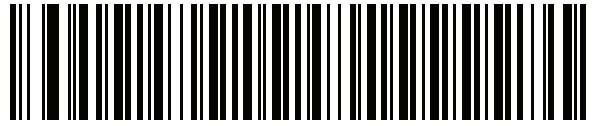


**Danish**

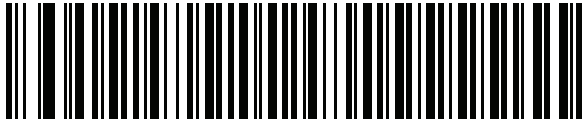


**Dutch (Netherlands)**

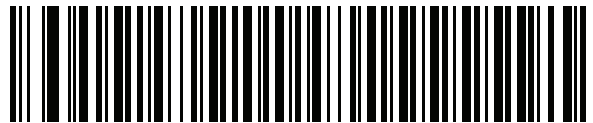




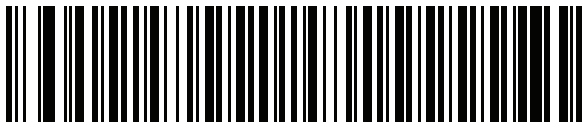
**Estonian**



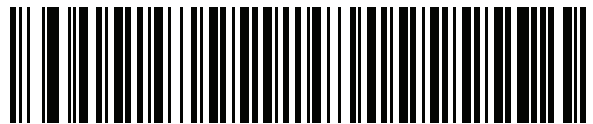
**Faeroese**



**Finnish**



**French (France)**



**French International  
(Belgian French)**



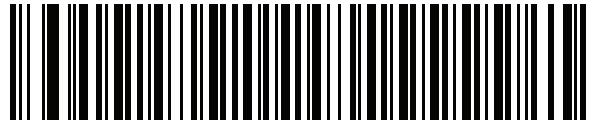
**French (Canada) 95/98**



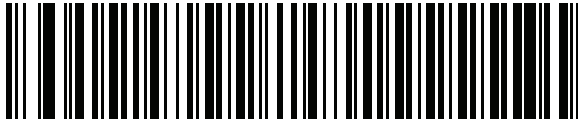
**French (Canada) 2000/XP\***

## Country Codes

\*Note that there is also a country code barcode for [Canadian Multilingual Standard on page 350](#). Be sure to select the appropriate barcode for your host system.



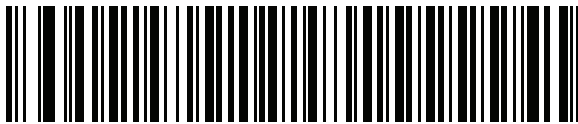
**Galician**



**German**



**Greek Latin**



**Greek (220) Latin**



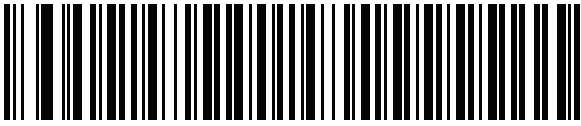
**Greek (319) Latin**



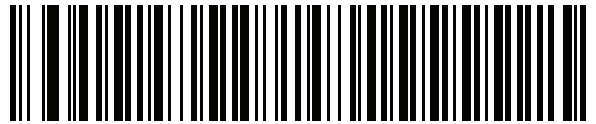
**Greek**



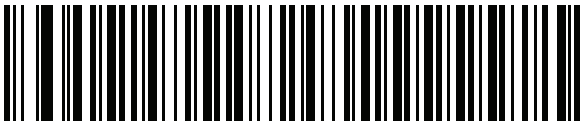
**Greek (220)**



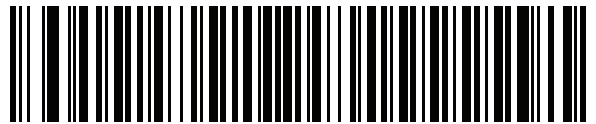
Greek (319)



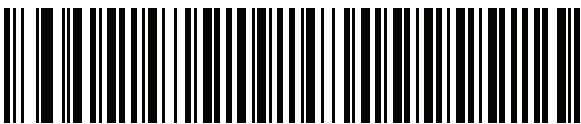
Greek Polytonic



Hebrew Israel



Hungarian



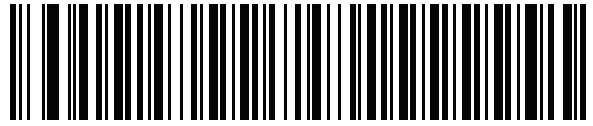
Hungarian\_101KEY



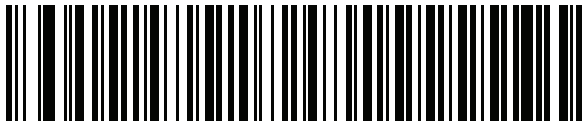
Icelandic



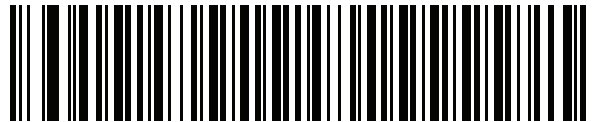
Irish



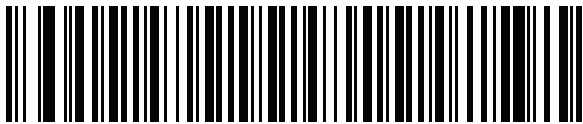
Italian



Italian (142)



Japanese (ASCII)



Japanese (SHIFT-JIS)\*

\*For CJK keyboard types, see [CJK Decode Control](#).



Kazakh

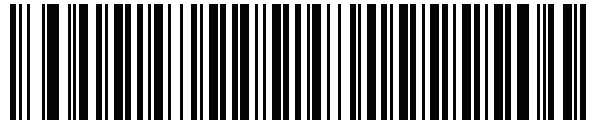


Korean (ASCII)

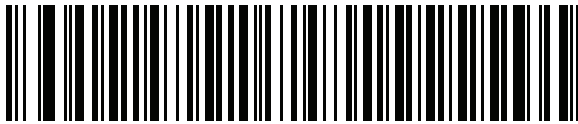


Korean (Hangul)\*

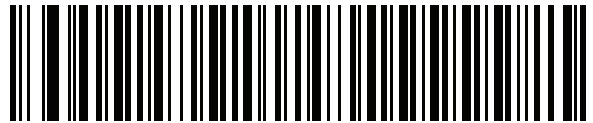
\*For CJK keyboard types, see [CJK Decode Control](#).



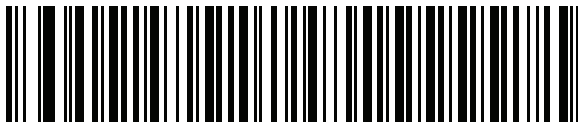
**Kyrgyz**



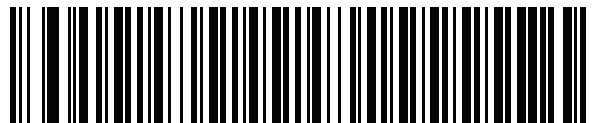
**Latin American**



**Latvian**



**Latvian (QWERTY)**



**Lithuanian**



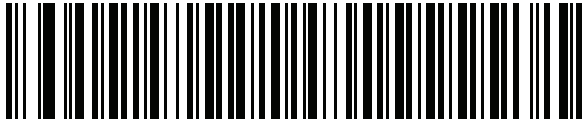
**Lithuanian (IBM)**



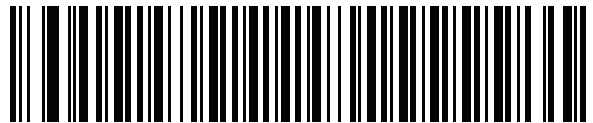
**Macedonian (FYROM)**



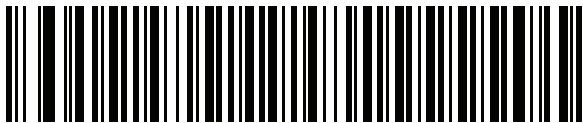
**Maltese\_47KEY**



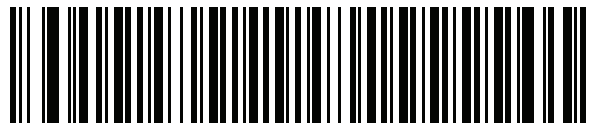
**Mongolian**



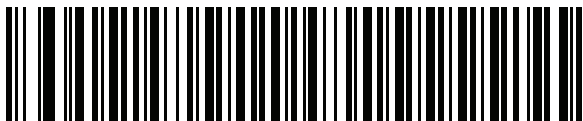
**Norwegian**



**Polish (214)**



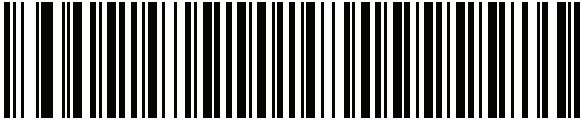
**Polish (Programmer)**



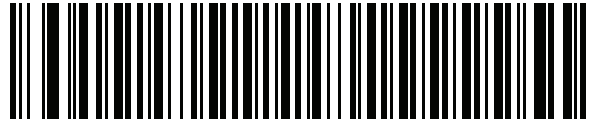
**Portuguese (Brazil)  
(Windows XP)**



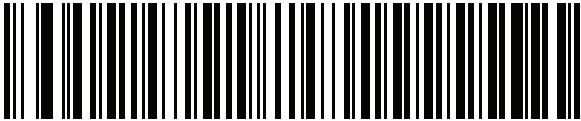
**Portuguese (Brazilian ABNT)**



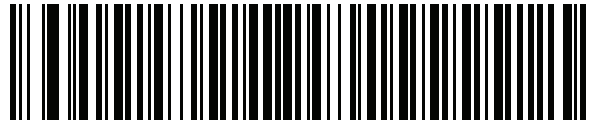
**Portuguese (Brazilian ABNT2)**



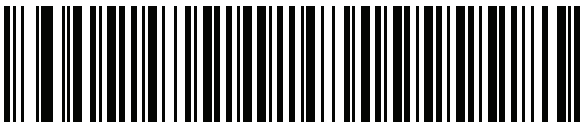
**Portuguese (Portugal)**



**Romanian  
(Windows XP)**



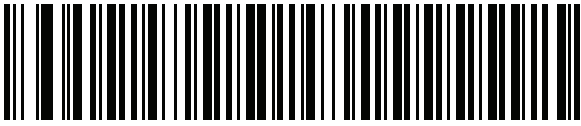
**Romanian (Legacy)  
(Win 7 or higher)**



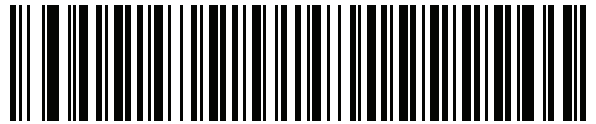
**Romanian (Standard)  
(Win 7 or higher)**



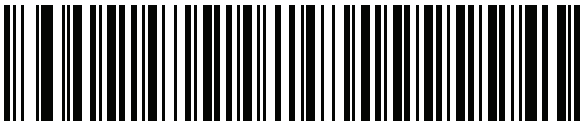
**Romanian (Programmer)  
(Win 7 or higher)**



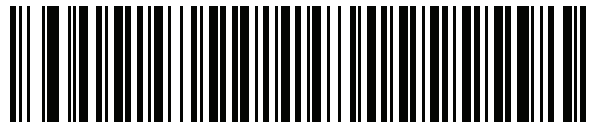
Russian



Russian (Typewriter)



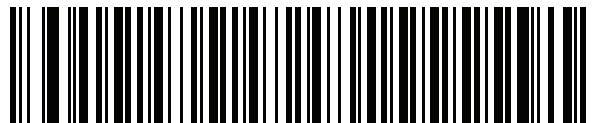
Serbian (Latin)



Serbian (Cyrillic)



Slovak

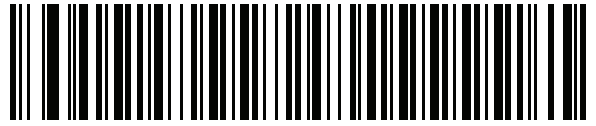


Slovak (QWERTY)

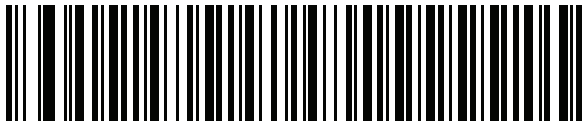


Slovenian

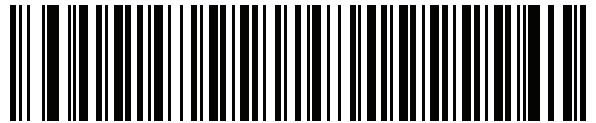




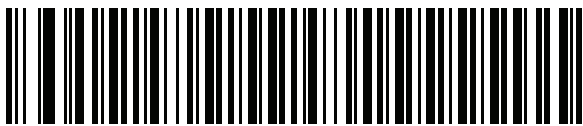
Spanish



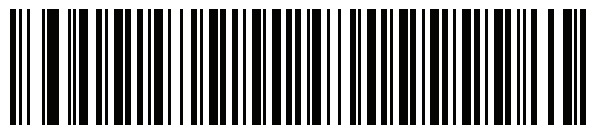
Spanish (Variation)



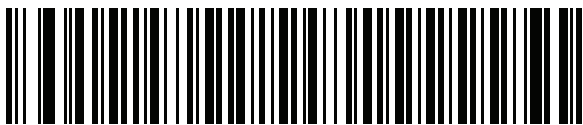
Swedish



Swiss French



Swiss German



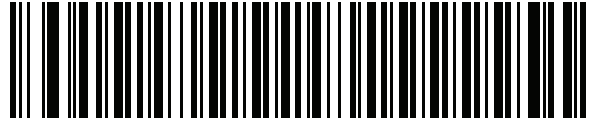
Tatar



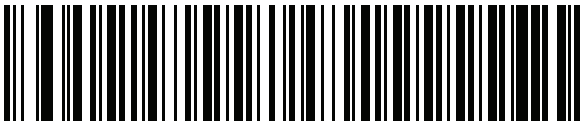
Thai (Kedmanee)



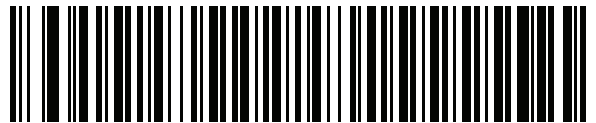
Turkish F



Turkish Q



UK English



Ukrainian



US Dvorak

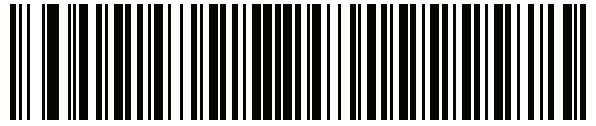


US Dvorak Left

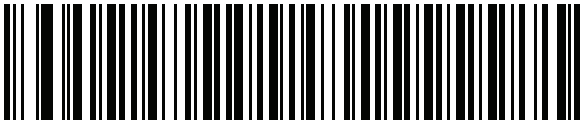


US Dvorak Right

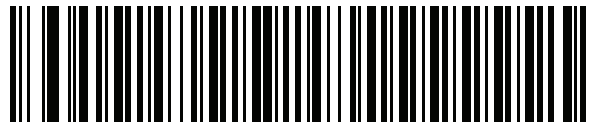
## Country Codes



**US International**



**Uzbek**



**Vietnamese**

# Country Code Pages

## Introduction

This chapter provides barcodes for selecting code pages for the country keyboard type selected in [Country Codes](#). If the default code page in [Table 25](#) is appropriate for your selected country keyboard type, you do not need to scan a country code page barcode.



**NOTE:** ADF rules can also specify a code page based on the symbology and other ADF criteria. Refer to the [Advanced Data Formatting Programmer Guide](#).

## Country Code Page Defaults

[Table 25](#) lists the code page default for each country keyboard.

**Table 25** Country Code Page Defaults

Country Keyboard	Code Page Default
US English (North American)	Windows 1252
US English (Mac)	Mac CP10000
Albanian	Windows 1250
Arabic 101	Windows 1256
Arabic 102	Windows 1256
Arabic 102 AZERTY	Windows 1256
Azeri Latin	Windows 1254
Azeri Cyrillic	Windows 1251
Belarusian	Windows 1251
Bosnian Latin	Windows 1250
Bosnian Cyrillic	Windows 1251
Bulgarian Latin	Windows 1250
Bulgarian Cyrillic	Windows 1251

**Table 25** Country Code Page Defaults (Continued)

Country Keyboard	Code Page Default
Canadian French Win7	Windows 1252
Canadian French (Legacy)	Windows 1252
Canadian Multilingual	Windows 1252
Croatian	Windows 1250
Chinese ASCII	Windows 1252
Chinese (Simplified)	Windows 936, GBK
Chinese (Traditional)	Windows 950, Big5
Czech	Windows 1250
Czech Programmers	Windows 1250
Czech QWERTY	Windows 1250
Danish	Windows 1252
Dutch Netherland	Windows 1252
Estonian	Windows 1257
Faeroese	Windows 1252
Finnish	Windows 1252
French (France)	Windows 1252
French (Canada) 95/98	Windows 1252
French (Canada) 2000/XP	Windows 1252
French International (Belgian French)	Windows 1252
Galician	Windows 1252
German	Windows 1252
Greek Latin	Windows 1252
Greek220 Latin	Windows 1253
Greek319 Latin	Windows 1252
Greek	Windows 1253
Greek220	Windows 1253
Greek319	Windows 1253
Greek Polytonic	Windows 1253
Hebrew Israel	Windows 1255
Hungarian	Windows 1250
Hungarian_101KEY	Windows 1250

**Table 25** Country Code Page Defaults (Continued)

Country Keyboard	Code Page Default
Icelandic	Windows 1252
Irish	Windows 1252
Italian	Windows 1252
Italian_142	Windows 1252
Japanese ASCII	Windows 1252
Japanese (Shift-JIS)	Windows 932, Shift-JIS
Kazakh	Windows 1251
Korean ASCII	Windows 1252
Korean (Hangul)	Windows 949, Hangul
Kyrgyz Cyrillic	Windows 1251
Latin America	Windows 1252
Latvian	Windows 1257
Latvian QWERTY	Windows 1257
Lithuanian	Windows 1257
Lithuanian_IBM	Windows 1257
Macedonian -FYROM	Windows 1251
Maltese_47KEY	Windows 1252
Mongolian-Cyrillic	Windows 1251
Norwegian	Windows 1252
Polish_214	Windows 1250
Polish Programmer	Windows 1250
Portuguese Brazil	Windows 1252
Portuguese Brazilian ABNT	Windows 1252
Portuguese Brazilian ABNT2	Windows 1252
Portuguese Portugal	Windows 1252
Romanian	Windows 1250
Romanian Legacy	Windows 1250
Romanian Standard	Windows 1250
Romanian Programmer	Windows 1250
Russian	Windows 1251
Russian Typewriter	Windows 1251

**Table 25** Country Code Page Defaults (Continued)

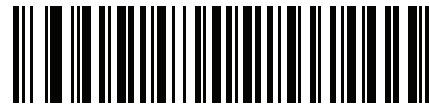
Country Keyboard	Code Page Default
Serbian Latin	Windows 1250
Serbian Cyrillic	Windows 1251
Slovak	Windows 1250
Slovak QWERTY	Windows 1250
Slovenian	Windows 1250
Spanish	Windows 1252
Spanish Variation	Windows 1252
Swedish	Windows 1252
Swiss French	Windows 1252
Swiss German	Windows 1252
Tatar	Windows 1251
Thai-Kedmanee	Windows 874
Turkish F	Windows 1254
Turkish Q	Windows 1254
Ukrainian	Windows 1251
United Kingdom	Windows 1252
United States	Windows 1252
US Dvorak	Windows 1252
US Dvorak Left Hand	Windows 1252
US Dvorak Right Hand	Windows 1252
US International	Windows 1252
Uzbek Cyrillic	Windows 1251
Vietnamese	Windows 1258

## Country Code Page Barcodes

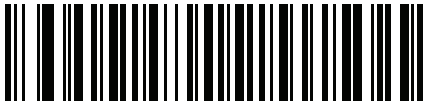
Scan the barcode corresponding to the country keyboard code page.



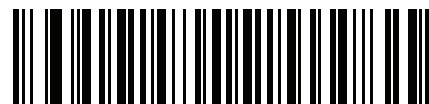
**Windows 1250**  
**Latin 2, Central European**



**Windows 1251**  
**Cyrillic, Slavic**



**Windows 1252**  
**Latin 1, Western European**



**Windows 1253**  
**Greek**



**Windows 1254**  
**Latin 5, Turkish**

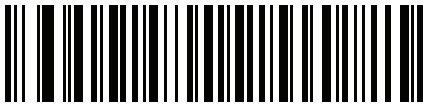




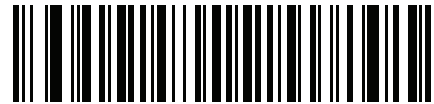
**Windows 1255  
Hebrew**



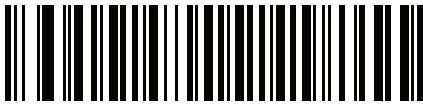
**Windows 1256  
Arabic**



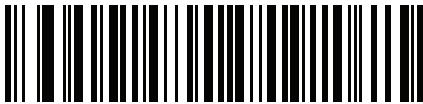
**Windows 1257  
Baltic**



**Windows 1258  
Vietnamese**



**Windows 874  
Thai**



**Windows 20866  
Cyrillic KOI8-R**



**Windows 932  
Japanese Shift-JIS**



**Windows 936  
Simplified Chinese GBK**



**Windows 54936  
Simplified Chinese GB18030**



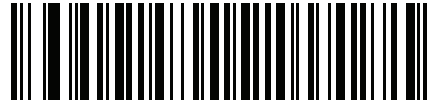
**Windows 949  
Korean Hangul**



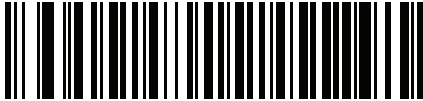
**Windows 950  
Traditional Chinese Big5**



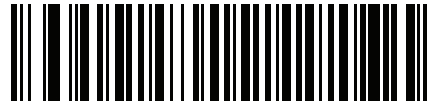
**MS-DOS 437  
Latin US**



**MS-DOS 737**  
Greek



**MS-DOS 775**  
Baltic



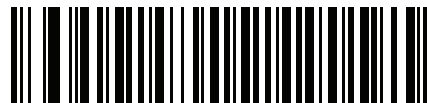
**MS-DOS 850**  
Latin 1



**MS-DOS 852**  
Latin 2



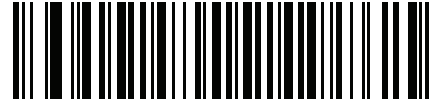
**MS-DOS 855**  
Cyrillic



**MS-DOS 857**  
Turkish



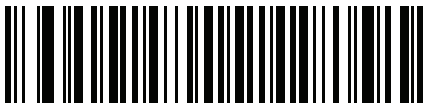
**MS-DOS 860**  
**Portuguese**



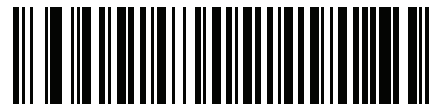
**MS-DOS 861**  
**Icelandic**



**MS-DOS 862**  
**Hebrew**



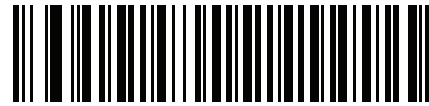
**MS-DOS 863**  
**French Canada**



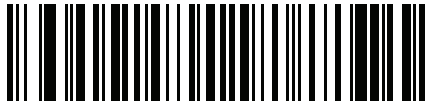
**MS-DOS 865**  
**Nordic**



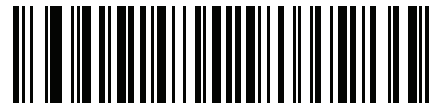
**MS-DOS 866**  
**Cyrillic**



**MS-DOS 869**  
**Greek 2**



**ISO 8859-1**  
**Latin 1, Western European**



**ISO 8859-2**  
**Latin 2, Central European**



**ISO 8859-3**  
**Latin 3, South European**



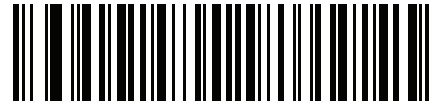
**ISO 8859-4**  
**Latin 4, North European**



**ISO 8859-5**  
**Cyrillic**



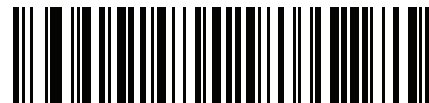
**ISO 8859-6**  
**Arabic**



**ISO 8859-7**  
**Greek**



**ISO 8859-8**  
**Hebrew**



**ISO 8859-9**  
**Latin 5, Turkish**



**ISO 8859-10**  
Latin 6, Nordic



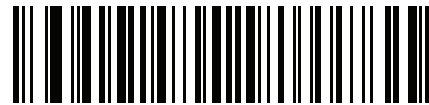
**ISO 8859-11**  
Thai



**ISO 8859-13**  
Latin 7, Baltic



**ISO 8859-14**  
Latin 8, Celtic



**ISO 8859-15**  
Latin 9



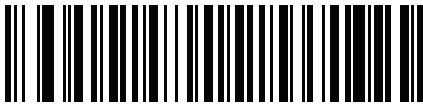
**ISO 8859-16**  
Latin 10, South-Eastern European



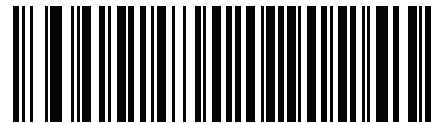
**UTF-8**



**UTF-16LE**  
**UTF-16 Little Endian**



**UTF-16BE**  
**UTF-16 Big Endian**



**Mac CP10000**  
**Roman**



# CKJ Decode Control

---

## Introduction

This appendix describes control parameters for CJK (Chinese, Japanese, Korean) barcode decode through Bluetooth HID Keyboard Emulation mode.



**NOTE:** Because ADF does not support CJK character processing, there is no format manipulation for CJK output.

## CJK Control Parameters

### Unicode Output Control

#### Parameter # 973

For a Unicode encoded CJK barcode, select one of the following options for unicode output:

- **Universal Output to Unicode and MBCS Application** - This default method applies to Unicode and MBCS expected applications, such as MS Word and Notepad on a Windows host.



**NOTE:** To support Unicode universal output, set up the registry table for the Windows host. See [Unicode/CJK Decode Setup with Windows Host on page 382](#).

- **Output to Unicode Application Only** - This method applies only to Unicode expected applications, such as MS Word and WordPad, but not Notepad.



**\*Universal Output  
(0)**



**Unicode Application Only  
(1)**

## CJK Output Method to Windows Host

### Parameter # 972

For a national standard encoded CJK barcode, select one of the following options for CJK output to a Windows host:

- **Universal CJK Output** - This is the default universal CJK output method for US English IME or Chinese/Japanese/Korean ASCII IME on a Windows host. This method converts CJK characters to Unicode and emulates the characters when transmitting to the host. Use the [Unicode Output Control](#) parameter to control Unicode output.



**NOTE:** To support universal CJK output, set up the registry table for the Windows host. See [Unicode/CJK Decode Setup with Windows Host on page 382](#).

- **Other options for CJK output** - With the following methods, the scanner sends the CJK character hexadecimal internal code (Nei Ma) value to host, or converts the CJK character to Unicode and sends the hexadecimal Unicode value to host. When using these methods, the Windows host must select the corresponding IME to accept the CJK character. See [Unicode/CJK Decode Setup with Windows Host on page 382](#).
  - **Japanese Unicode Output**
  - **Simplified Chinese GBK Code Output**
  - **Simplified Chinese Unicode Output**
  - **Korean Unicode Code Output**
  - **Traditional Chinese Big5 Code Output** (Windows XP)
  - **Traditional Chinese Big5 Code Output** (Windows 7)
  - **Traditional Chinese Unicode Code Output** (Windows XP)
  - **Traditional Chinese Unicode Code Output** (Windows 7)



**NOTE:** The Unicode emulate output method depends on the host system (Windows XP or Windows 7).



\*Universal CJK Output  
(0)



Japanese Unicode Output  
(34)

(for Japanese Unicode Output, select Simplified Chinese Unicode IME on the Windows host)

## CJK Output Method to Windows Host (continued)



**Chinese (Simplified) GBK Output  
(1)**

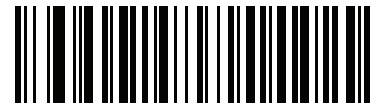


**Chinese (Simplified) Unicode Output  
(2)**

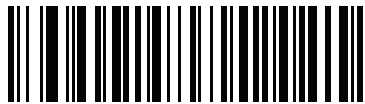


**Korean Unicode Output  
(50)**

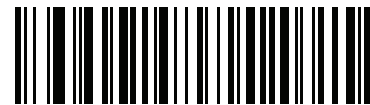
(for Korean Unicode Output, select Simplified Chinese Unicode IME on the Windows host)



**Chinese (Traditional) Big5 Output (Windows XP)  
(17)**



**Chinese (Traditional) Big5 Output (Windows 7)  
(19)**



**Chinese (Traditional) Unicode Output (Windows XP)  
(18)**



**Chinese (Traditional) Unicode Output (Windows 7)  
(20)**

## Non-CJK UTF Barcode Output

### Parameter # 960

Some country keyboard type layouts contain characters that do not exist in the default code page (see [Country Keyboard Type Missing Characters on page 380](#)). Although the default code page can not encode these characters in a barcode, they can be encoded in the UTF-8 barcode. Scan this parameter barcode to output the Unicode values by emulation mode.



**NOTE:** Use this special country keyboard type to decode the non-CJK UTF-8 barcode. After decoding, re-configure the scanner to use the original country keyboard type.

Use US English IME on Windows. See [Unicode Output Control on page 377](#).



Non-CJK UTF-8 Emulation Output

### Country Keyboard Type Missing Characters

Country keyboard type: **Tatar, Uzbek, Mongolian, Kyrgyz, Kazakh and Azeri**

Default code page: CP1251

Missing characters:

**Table 26** Country Keyboard Type: Tatar, Uzbek, Mongolian, Kyrgyz, Kazakh and Azeri

ƒ	F
χ	Χ
κ	Κ
h	h
ϑ	Θ
ϑ	Θ
γ	Υ
Ғ	Ғ
Ж	Ж
Ғ	
Ғ	Ғ
Ғ	Ғ
Ғ	Ғ

**Table 26** Country Keyboard Type: Tatar, Uzbek, Mongolian, Kyrgyz, Kazakh and Azeri (Continued)

җ	җ
к	к

Country keyboard type: **Romanian (Standard)**

Default code page: CP1250


Missing characters:

**Table 27** Country Keyboard Type: Romanian (Standard)

ș	Ș
ț	Ț

Country keyboard type: **Portuguese-Brazilian (ABNT), Portuguese-Brazilian (ABNT2)**

Default code page: CP1252

Missing character: 

Country keyboard type: **Azeri-Latin**

Default code page: CP1254

Missing characters: ə , Ə

## Unicode/CJK Decode Setup with Windows Host

This section describes how to set up CJK decode with a Windows host.

### Setting Up the Windows Registry Table for Unicode Universal Output

To support the Unicode universal output method, set up the Windows host registry table as follows:

1. Select **Start > Run > regedt32** to start the registry editor.
2. Under **HKEY\_Current\_User\Control Panel\Input Method**, set **EnableHexNumpad** to **1** as follows:

```
[HKEY_CURRENT_USER\Control Panel\Input Method]
```

```
"EnableHexNumpad"="1"
```

If this key does not exist, add it as type **REG\_SZ** (string value).

3. Reboot the computer to implement the registry change.

### Adding CJK IME on Windows

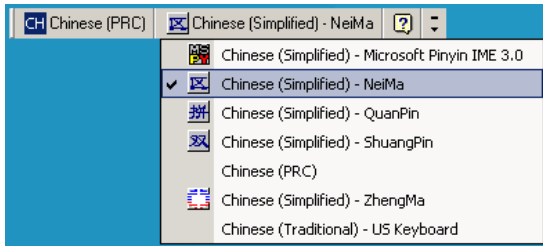
To add the desired CJK input language:

1. Click **Start > Control Panel**.
2. If the Control Panel opens in category view, select **Switch to Classic View** in the top left corner.
3. Select **Regional and Language Options**.
4. Click the **Language** tab.
5. Under **Supplemental Language Support**, select the **Install Files for East Asian Languages** check box if not already selected, and click **Apply**. This may require a Windows installation CD to install the required files. This step ensures that the East Asian Languages (CJK) are available.
6. Under **Text Services and Input Language**, click **Details**.
7. Under **Installed Services**, click **Add**.
8. In the **Add Input Language** dialog box, choose the CJK input language and keyboard layout or Input Method Editor (IME) to add.
9. Click **OK** twice. The language indicator appears in the system tray (at bottom right corner of the desktop by default). To switch between input languages (keyboard languages) select the language indicator in the system tray.
10. Select the language indicator in the system tray to select the desired country keyboard type.
11. Verify that the characters displayed on each country's keyboard appear.

## Selecting the Simplified Chinese Input Method on the Host

To select the Simplified Chinese input method:

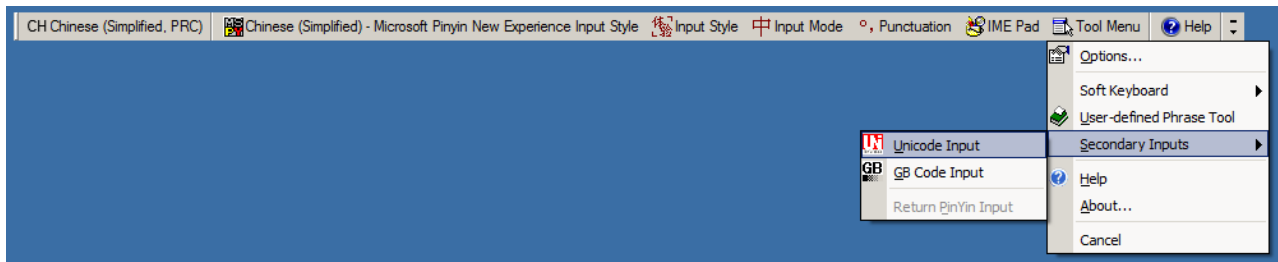
- Select Unicode/GBK input on Windows XP: **Chinese (Simplified) - NeiMa**, then click the input bar to select **Unicode** or **GBK NeiMa** input.



Or



- Select Unicode/GBK input on Windows7: **Chinese (Simplified) - Microsoft Pinyin New Experience Input Style**, then select **Tool Menu > Secondary Inputs > Unicode Input** or **GB Code Input**.

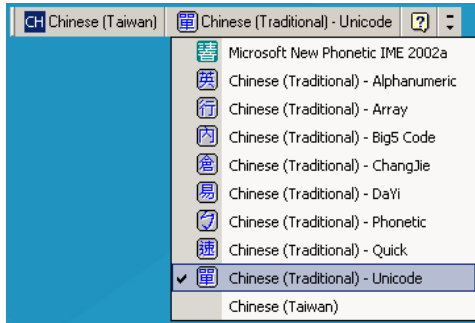




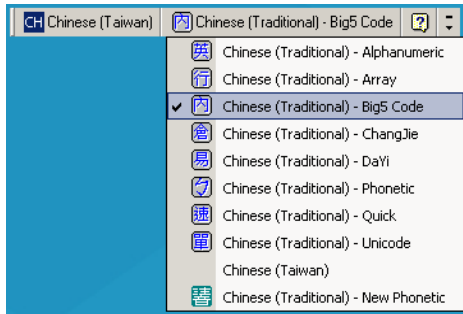
## Selecting the Traditional Chinese Input Method on the Host

To select the Traditional Chinese input method:

- Select Unicode input on Windows XP: **Chinese (Traditional) - Unicode**



- Select Big5 input on Windows XP: **Chinese (Traditional) - Big5 Code**



- Select Unicode/Big5 input on Windows 7: **Chinese (Traditional) - New Quick**. This option support both Unicode and Big5 input.



# ASCII Character Sets

**Table 28** ASCII Value Table

ASCII Value	Full ASCII Code 39 Encode Char	Keystroke
1000	%U	CTRL 2
1001	\$A	CTRL A
1002	\$B	CTRL B
1003	\$C	CTRL C
1004	\$D	CTRL D
1005	\$E	CTRL E
1006	\$F	CTRL F
1007	\$G	CTRL G
1008	\$H	CTRL H/ <b>BACKSPACE</b> <sup>1</sup>
1009	\$I	CTRL I/ <b>HORIZONTAL TAB</b> <sup>1</sup>
1010	\$J	CTRL J
1011	\$K	CTRL K
1012	\$L	CTRL L
1013	\$M	CTRL M/ <b>ENTER</b> <sup>1</sup>
1014	\$N	CTRL N
1015	\$O	CTRL O
1016	\$P	CTRL P
1017	\$Q	CTRL Q
1018	\$R	CTRL R
1019	\$S	CTRL S

The keystroke in bold transmits only if you enabled Function Key Mapping. Otherwise, the unbold keystroke transmits.

**Table 28** ASCII Value Table (Continued)

ASCII Value	Full ASCII Code 39 Encode Char	Keystroke
1020	\$T	CTRL T
1021	\$U	CTRL U
1022	\$V	CTRL V
1023	\$W	CTRL W
1024	\$X	CTRL X
1025	\$Y	CTRL Y
1026	\$Z	CTRL Z
1027	%A	CTRL [
1028	%B	CTRL \
1029	%C	CTRL ]
1030	%D	CTRL 6
1031	%E	CTRL -
1032	Space	Space
1033	/A	!
1034	/B	"
1035	/C	#
1036	/D	\$
1037	/E	%
1038	/F	&
1039	/G	'
1040	/H	(
1041	/I	)
1042	/J	*
1043	/K	+
1044	/L	,
1045	-	-
1046	.	.
1047	/o	/
1048	0	0

The keystroke in bold transmits only if you enabled Function Key Mapping. Otherwise, the unbold keystroke transmits.

**Table 28** ASCII Value Table (Continued)

ASCII Value	Full ASCII Code 39 Encode Char	Keystroke
1049	1	1
1050	2	2
1051	3	3
1052	4	4
1053	5	5
1054	6	6
1055	7	7
1056	8	8
1057	9	9
1058	/Z	:
1059	%F	;
1060	%G	<
1061	%H	=
1062	%I	>
1063	%J	?
1064	%V	@
1065	A	A
1066	B	B
1067	C	C
1068	D	D
1069	E	E
1070	F	F
1071	G	G
1072	H	H
1073	I	I
1074	J	J
1075	K	K
1076	L	L
1077	M	M

The keystroke in bold transmits only if you enabled Function Key Mapping. Otherwise, the unbold keystroke transmits.

**Table 28** ASCII Value Table (Continued)

ASCII Value	Full ASCII Code 39 Encode Char	Keystroke
1078	N	N
1079	O	O
1080	P	P
1081	Q	Q
1082	R	R
1083	S	S
1084	T	T
1085	U	U
1086	V	V
1087	W	W
1088	X	X
1089	Y	Y
1090	Z	Z
1091	%K	[
1092	%L	\
1093	%M	]
1094	%N	^
1095	%O	_
1096	%W	'
1097	+A	<b>a</b>
1098	+B	<b>b</b>
1099	+C	<b>c</b>
1100	+D	<b>d</b>
1101	+E	<b>e</b>
1102	+F	<b>f</b>
1103	+G	<b>g</b>
1104	+H	<b>h</b>
1105	+I	<b>i</b>
1106	+J	<b>j</b>

The keystroke in bold transmits only if you enabled Function Key Mapping. Otherwise, the unbold keystroke transmits.

**Table 28** ASCII Value Table (Continued)

ASCII Value	Full ASCII Code 39 Encode Char	Keystroke
1107	+K	k
1108	+L	l
1109	+M	m
1110	+N	n
1111	+O	o
1112	+P	p
1113	+Q	q
1114	+R	r
1115	+S	s
1116	+T	t
1117	+U	u
1118	+V	v
1119	+W	w
1120	+X	x
1121	+Y	y
1122	+Z	z
1123	%P	{
1124	%Q	
1125	%R	}
1126	%S	~

The keystroke in bold transmits only if you enabled Function Key Mapping. Otherwise, the unbold keystroke transmits.

**Table 29** ALT Key Standard Default Tables

ALT Keys	Keystroke
2064	ALT 2
2065	ALT A
2066	ALT B
2067	ALT C
2068	ALT D

**Table 29** ALT Key Standard Default Tables (Continued)

ALT Keys	Keystroke
2069	ALT E
2070	ALT F
2071	ALT G
2072	ALT H
2073	ALT I
2074	ALT J
2075	ALT K
2076	ALT L
2077	ALT M
2078	ALT N
2079	ALT O
2080	ALT P
2081	ALT Q
2082	ALT R
2083	ALT S
2084	ALT T
2085	ALT U
2086	ALT V
2087	ALT W
2088	ALT X
2089	ALT Y
2090	ALT Z

**Table 30** USB GUI Key Character Set

GUI Key	Keystroke
3000	Right Control Key
3048	GUI 0
3049	GUI 1
3050	GUI 2

Note: GUI Shift Keys - The Apple™ iMac keyboard has an apple key on either side of the space bar. Windows-based systems have a GUI key to the left of the left ALT key, and to the right of the right ALT key.

**Table 30** USB GUI Key Character Set (Continued)

GUI Key	Keystroke
3051	GUI 3
3052	GUI 4
3053	GUI 5
3054	GUI 6
3055	GUI 7
3056	GUI 8
3057	GUI 9
3065	GUI A
3066	GUI B
3067	GUI C
3068	GUI D
3069	GUI E
3070	GUI F
3071	GUI G
3072	GUI H
3073	GUI I
3074	GUI J
3075	GUI K
3076	GUI L
3077	GUI M
3078	GUI N
3079	GUI O
3080	GUI P
3081	GUI Q
3082	GUI R
3083	GUI S
3084	GUI T
3085	GUI U
3086	GUI V
3087	GUI W

Note: GUI Shift Keys - The Apple™ iMac keyboard has an apple key on either side of the space bar. Windows-based systems have a GUI key to the left of the left ALT key, and to the right of the right ALT key.



**Table 30** USB GUI Key Character Set (Continued)

GUI Key	Keystroke
3088	GUI X
3089	GUI Y
3090	GUI Z

Note: GUI Shift Keys - The Apple <sup>TM</sup> iMac keyboard has an apple key on either side of the space bar. Windows-based systems have a GUI key to the left of the left ALT key, and to the right of the right ALT key.

**Table 31** PF Key Standard Default Table

PF Keys	Keystroke
4001	PF 1
4002	PF 2
4003	PF 3
4004	PF 4
4005	PF 5
4006	PF 6
4007	PF 7
4008	PF 8
4009	PF 9
4010	PF 10
4011	PF 11
4012	PF 12
4013	PF 13
4014	PF 14
4015	PF 15
4016	PF 16

**Table 32** F key Standard Default Table

F Keys	Keystroke
5001	F 1
5002	F 2
5003	F 3
5004	F 4

**Table 32** F key Standard Default Table (Continued)

F Keys	Keystroke
5005	F 5
5006	F 6
5007	F 7
5008	F 8
5009	F 9
5010	F 10
5011	F 11
5012	F 12
5013	F 13
5014	F 14
5015	F 15
5016	F 16
5017	F 17
5018	F 18
5019	F 19
5020	F 20
5021	F 21
5022	F 22
5023	F 23
5024	F 24

**Table 33** Numeric Key Standard Default Table

Numeric Keypad	Keystroke
6042	*
6043	+
6044	Undefined
6045	-
6046	.
6047	/
6048	0
6049	1

**Table 33** Numeric Key Standard Default Table (Continued)

Numeric Keypad	Keystroke
6050	2
6051	3
6052	4
6053	5
6054	6
6055	7
6056	8
6057	9
6058	Enter
6059	Num Lock

**Table 34** Extended Keypad Standard Default Table

Extended Keypad	Keystroke
7001	Break
7002	Delete
7003	Pg Up
7004	End
7005	Pg Dn
7006	Pause
7007	Scroll Lock
7008	Backspace
7009	Tab
7010	Print Screen
7011	Insert
7012	Home
7013	Enter
7014	Escape
7015	Up Arrow
7016	Dn Arrow
7017	Left Arrow
7018	Right Arrow

# RSM Attributes

---

## Attributes for Querying Scanner Information

Remote Scanner Manager (RSM) attributes can be used to query information, like Serial Number and Battery Percentage, from a connected RS5100 scanner. The following table describes various attributes and their attribute numbers.

**Table 35** Remote Scanner Manager (RSM) Attributes

Attribute Description	Attribute Number
Model Number	533
Serial Number	534
Date of Manufacture	535
Date of Service	536
Bluetooth MAC Address	541
Firmware Version	20004
Battery Voltage	30010
Battery Percentage	30012
Battery State of Health	30013
Battery Model Number	30017
Battery Manufacture Date	30018
Battery Full Charge Capacity	30020

# INDEX

## Numerics

123Scan	27
requirements	28
2D barcodes	
aztec	233
aztec inverse	233
code 128 emulation	229
data matrix	230
data matrix inverse	231
han xin	234
han xin inverse	234
maxicode	231
microPDF417	228
microQR	233
PDF417	228
QR code	232

## A

Acceptable Aiming Options	25
accessories	82
ADF	256
advanced data formatting	256
auto-reconnect	72

## B

bar codes	
Australia post	243
Australia post format	244
auto-reconnect interval	72
batch mode	78, 80
beep after good decode	118
beep on insertion	118
beeper duration	121
beeper tone	120
beeper volume	119
Bluetooth technology support	37
bookland EAN	154
bookland ISBN	167
buffering	187, 188

cancel	325
Chinese 2 of 5	215
codabar	206
codabar CLSI editing	208
codabar lengths	206
codabar NOTIS editing	208
codabar start and stop characters	209
code 11	192
code 11 check digit verification	194
code 11 lengths	192
code 128	171
code 128 lengths	172
code 128 reduced quiet zone	178
code 128 security level	177
code 32 prefix	182
code 39	180
transmit buffer	189
code 39 check digit verification	184
code 39 full ASCII	185
code 39 lengths	183
code 39 reduced quiet zone	187
code 39 security level	186
code 39 transmit check digit	184
code 93	190
code 93 lengths	190
composite beep mode	227
composite CC-A/B	224
composite CC-C	224
composite TLC-39	225
continuous bar code read	126
convert code 39 to code 32	181
convert GS1 databar to UPC/EAN	222
convert UPC-E to UPC-A	165
convert UPC-E1 to UPC-A	165
country code page defaults	363
country code pages	367
country codes	348
decode mirror images	131
decode session timeout	128
digimarc	255
digimarc digital watermarks	255
disable all code types	151

discrete 2 of 5	203
discrete 2 of 5 lengths	204
EAN zero extend	166
EAN-13/JAN-13	154
EAN-8/JAN-8	153
enable all code types	151
enter	136
flush macro buffer/abort macro PDF entry	253
FN1 substitution values	140
fuzzy 1D processing	130
GS1 databar bar codes	221
GS1 databar expanded	222
GS1 databar limited	221
GS1 databar limited security level	223
GS1 databar-14	221
GS1-128	174
GS1-128 emulation mode	227
I 2 of 5 check digit verification	199
I 2 of 5 convert to EAN-13	200
I 2 of 5 reduced quiet zone	202
I 2 of 5 security level	201
I 2 of 5 transmit check digit	200
ignore code 128 fnc4	178
illumination	135
intercharacter gap size	252
interleaved 2 of 5	196
convert to EAN-13	200, 201
interleaved 2 of 5 lengths	197
inverse 1D	220
ISBT 128	174
ISBT concatenation	175, 176
ISBT concatenation redundancy	176
ISSN EAN	170
Japan postal	242
Korean 3 of 5	219
matrix 2 of 5	216
matrix 2 of 5 check digit	218
matrix 2 of 5 lengths	216, 217
mobile phone/display mode	132
motion tolerance	136
MSI	210
MSI check digit algorithm	214
MSI check digits	212
MSI lengths	210
MSI transmit check digit	212
Netherlands KIX code	245
numeric bar codes	325
OCR	
check digit	283
check digit multiplier	284
check digit validation	286
default table	258
inverse OCR	291
lines	271
maximum characters	272
MICR E13B	268
minimum character	271
OCR-A	260
OCR-A variant	261
OCR-B	263
OCR-B variant	264
orientation	269
parameters	260
quiet zone	273
redundancy	292
subset	272
template	274
US currency serial number	269
parameter scanning	117
PDF prioritization	133
PDF prioritization timeout	134
picklist mode	125
postal	240
prefix/suffix values	137
quiet zone level	251
reconnect attempt beep	73
reconnect attempt interval	73
redundancy level	248
report version	252
samples	343
scan data options	138
security level	250
set defaults	116
suppress power up beeps	121
sybologies	
default table	145
timeout between decodes, different symbols	130
timeout between decodes, same symbol	129
transmit code 11 check digits	195
transmit code ID character	136
transmit matrix 2 of 5 check digit	218
transmit no read message	141
transmit UK postal check digit	242
transmit US postal check digit	241
trigger mode	123
trioptic code 39	180
UCC coupon extended code	168
UK postal	241
unicode output control	377
unique bar code reporting	127
unpair	77
UPC composite mode	226
UPC reduced quiet zone	160
UPC/EAN	
coupon code	168
UPC/EAN supplemental AIM ID format	159
UPC/EAN supplemental redundancy	158
UPC/EAN supplementals	155

UPC-A	152	Chinese 2 of 5 bar codes	215
UPC-A check digit	160	CJK	376
UPC-A preamble	162	codabar bar codes	206
UPC-E	152	CLSI editing	208
UPC-E check digit	161	lengths	206
UPC-E preamble	163	NOTIS editing	208
UPC-E1	153	start and stop characters	209
UPC-E1 check digit	161	code 11 bar codes	192
UPC-E1 preamble	164	check digit verification	194
UPU FICS postal	246	lengths	192
US planet	240	transmit check digit	195
US postnet	240	code 128 bar codes	171
USB		GS1-128	174
country keyboard types (country codes)	348	ignore fnc4	178
USPS 4CB/One Code/Intelligent Mail	245	ISBT 128	174
variable PIN code	67	ISBT concatenation	175, 176
wi-fi friendly mode	68	ISBT concatenation redundancy	176
barcode defaults		lengths	172
bluetooth communication	30	reduced quiet zone	178
barcodes		security level	177
aztec	233	code 128 emulation barcodes	229
aztec inverse	233	code 39 bar codes	180
bluetooth		buffering	187, 188
SSI	46	check digit verification	184
code 128 emulation	229	code 32 prefix	182
data matrix	230	code 39	180
data matrix inverse	231	code 39 security Level	186
han xin	234	convert code 39 to code 32	181
han xin inverse	234	full ASCII	185
maxicode	231	lengths	183
microPDF417	228	reduced quiet zone	187
microQR	233	transmit check digit	184
PDF417	228	trioptic	180
QR code	232	code 93 bar codes	190
radio communication		lengths	190
SSI	46	code ID character	136
batch mode stored data	78	code identifiers	
battery		AIM code IDs	319
charging	21	modifier characters	320
Bluetooth		Symbol	318
encryption	68	Cold Boot	26
HID	37	composite bar codes	
pin code	66	beep mode	227
secure simple pairing IO capability	68	composite CC-A/B	224
SPP	72	composite CC-C	224
bluetooth communication		composite TLC-39	225
defaults	30	GS1-128 emulation mode	227
bright center dot	24	UPC composite mode	226
bullets	13	conventions	
		notational	13
<b>C</b>		country code page defaults	363
central serial port profile	72	country code pages	367
charging batteries	21	country codes	348
		Cross Hair Lines	24

## D

data matrix barcodes	230
default parameters	
bluetooth communication	30
OCR	258
setting	116
standard default table	309
symbolologies	145
digimarc	254
digital watermarks bar codes	255
digimarc digital watermarks	255
discrete 2 of 5 bar codes	203
lengths	204

## E

encryption	68
error indications	
miscellaneous scanner options	30
exposure options	
illumination	135

## G

getting started	19
GS1 databar	221
GS1 databar bar codes	
convert GS1 databar to UPC/EAN	222
GS1 databar expanded	222
GS1 databar limited	221
GS1 databar limited security level	223
GS1 databar-14	221

## I

illumination	135
information, service	14
interleaved 2 of 5 bar codes	196
check digit verification	199
convert to EAN-13	200
lengths	197
reduced quiet zone	202
security level	201
transmit check digit	200

## K

keyboard types (country codes)	
Albanian	348
Arabic (101)	348
Arabic (102)	348
Arabic (102) Azerty	349
Azeri (Cyrillic)	349

Azeri (Latin)	349
Belarusian	349
Bosnian (Cyrillic)	349
Bosnian (Latin)	349
Bulgarian (Latin)	349
Bulgarian Cyrillic (Typewriter)	350
Canadian French (Legacy)	350
Canadian French Win7	350
Canadian Multilingual Standard	350
Chinese (ASCII)	350
Croatian	351
Czech	351
Czech (Programmer)	351
Czech (QWERTY)	351
Danish	351
Dutch (Netherlands)	351
Estonian	352
Faeroese	352
Finnish	352
French (Canada) 2000/XP	352
French (Canada) 95/98	352
French (France)	352
French International	352
Galician	353
German	353
Greek	353
Greek (220) Latin	353
Greek (319) Latin	353
Greek 220	353
Greek 319	354
Greek Latin	353
Greek Polytonic	354
Hebrew Israel	354
Hungarian	354
Hungarian_101KEY	354
Irish	354
Islandic	354
Italian	355
Italian (142)	355
Japanese (ASCII)	355
Kazakh	355
Korean (ASCII)	355
Kyrgyz	356
Latin American	356
Latvian	356
Latvian (QWERTY)	356
Lithuanian	356
Lithuanian (IBM)	356
Macedonian (FYROM)	356
Maltese_47KEY	357
Mongolian	357
Norwegian	357
Polish (214)	357
Polish (Programmer)	357



- Portuguese (Brazil) . . . . . 357
  - Portuguese (Brazilian ABNT) . . . . . 357
  - Portuguese (Brazilian ABNT2) . . . . . 358
  - Portuguese (Portugal) . . . . . 358
  - Romanian . . . . . 358
  - Romanian (Legacy) . . . . . 358
  - Romanian (Programmer) . . . . . 358
  - Romanian (Standard) . . . . . 358
  - Russian . . . . . 359
  - Russian (Typewriter) . . . . . 359
  - Serbian (Cyrillic) . . . . . 359
  - Serbian (Latin) . . . . . 359
  - Slovak . . . . . 359
  - Slovak (QWERTY) . . . . . 359
  - Slovenian . . . . . 359
  - Spanish . . . . . 360
  - Spanish (Variation) . . . . . 360
  - Swedish . . . . . 360
  - Swiss French . . . . . 360
  - Swiss German . . . . . 360
  - Tatar . . . . . 360
  - Thai (Kedmanee) . . . . . 360
  - Turkish F . . . . . 361
  - Turkish Q . . . . . 361
  - UK English . . . . . 361
  - Ukranian . . . . . 361
  - US Dvorak . . . . . 361
  - US Dvorak Left . . . . . 361
  - US Dvorak Right . . . . . 361
  - US English . . . . . 348
  - US International . . . . . 362
  - Uzbek . . . . . 362
  - Vietnamese . . . . . 362
  - Korean 3 of 5 bar codes . . . . . 219
- L**
- lock override . . . . . 49
  - low power mode . . . . . 72
- M**
- macro PDF . . . . . 253
    - flush buffer/abort PDF entry . . . . . 253
  - matrix 2 of 5 bar codes . . . . . 216
    - check digit . . . . . 218
    - lengths . . . . . 216, 217
    - transmit check digit . . . . . 218
  - maxicode barcodes . . . . . 231
  - MDF . . . . . 256
  - microPDF417 barcodes . . . . . 228
  - MSI bar codes . . . . . 210
    - check digit algorithm . . . . . 214
    - check digits . . . . . 212
  - lengths . . . . . 210
  - transmit check digit . . . . . 212
  - multicode data formatting . . . . . 256
- O**
- OCR
    - default parameters . . . . . 258
    - parameters . . . . . 260
- P**
- pairing
    - bar code format . . . . . 77
    - lock override . . . . . 49
    - pin codes . . . . . 66
    - unpair . . . . . 77
  - parameter defaults
    - bluetooth communication . . . . . 30
  - parameters
    - batch mode . . . . . 78, 80
    - beep on insertion . . . . . 118
    - Bluetooth technology support . . . . . 37
    - radio communication
      - auto-reconnect interval . . . . . 72
      - batch mode . . . . . 78, 80
      - reconnect attempt beep . . . . . 73
      - reconnect attempt interval . . . . . 73
      - unpair . . . . . 77
  - PDF417 bar codes
    - PDF prioritization . . . . . 133
  - PDF417 barcodes . . . . . 228
  - PIN code
    - static . . . . . 67
    - variable . . . . . 67
  - postal codes . . . . . 240
    - Australia post . . . . . 243
    - Australia post format . . . . . 244
    - Japan postal . . . . . 242
    - Netherlands KIX code . . . . . 245
    - transmit UK postal check digit . . . . . 242
    - transmit US postal check digit . . . . . 241
    - UK postal . . . . . 241
    - UPU FICS postal . . . . . 246
    - US planet . . . . . 240
    - US postnet . . . . . 240
    - USPS 4CB/One Code/Intelligent Mail . . . . . 245
  - preferred symbol . . . . . 257
- Q**
- QR code barcodes . . . . . 232

## R

radio communication	
reconnect attempt	73
reconnect attempt beep	73
reconnect attempt	73
reconnect attempt beep	73
Resetting	26

## S

sample bar codes	343
scanning	
errors	114, 144
radio communications sequence example	30
sequence example	114, 144
secure simple pairing IO capability	68
security	
intercharacter gap size	252
quiet zone level	251
redundancy level	248
security level	250
Serial Port Profile	
central	72
service information	14
setting defaults	116
software tools	
123Scan	27
ADF	256
MDF	256
preferred symbol	257
SPP	
central	72
standard default parameters	309
stored data	
batch mode	78
Symbol Scan Orientation	25
sympology default parameters	145

## T

trigger mode	123
Trigger Position	19

## U

unicode	
output control	377
unpacking	15
unpairing	
bar code	77
UPC/EAN bar codes	
bookland EAN	154
bookland ISBN	167

check digit	160, 161
convert UPC-E to UPC-A	165
convert UPC-E1 to UPC-A	165
EAN zero extend	166
EAN-13/JAN-13	154
EAN-8/JAN-8	153
ISSN EAN	170
reduced quiet zone	160
supplemental AIM ID format	159
supplemental redundancy	158
supplementals	155
UCC coupon extended code	168
UPC-A	152
UPC-A preamble	162
UPC-E	152
UPC-E preamble	163
UPC-E1	153
UPC-E1 preamble	164
user preferences bar codes	
batch mode	78, 80
beep on insertion	118

## W

Warm Boot	26
wi-fi friendly mode	68

