



Impressora TSC TE200 e TE300

A TSC TE200 oferece aos clientes uma impressora de mesa competitiva, durável e de nível básico, versátil e fácil de usar. Essa impressora, econômica e eficiente, imprimirá etiquetas de alta qualidade durante todo o dia.

TE200/TE210/TE300/TE310 Series

**THERMAL TRANSFER/DIRECT THERMAL BAR
CODE PRINTER**

**USER'S
MANUAL**

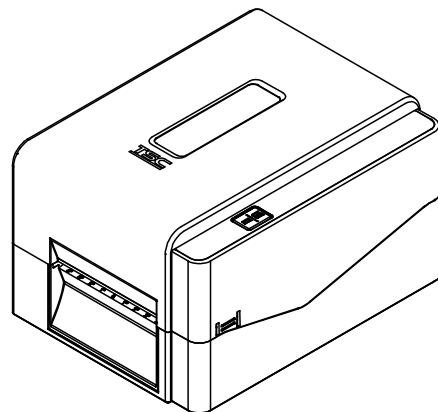

Copyright Information

©2017 TSC Auto ID Technology Co., Ltd,

The copyright in this manual, the software, and firmware in the printer described therein are owned by TSC Auto ID Technology Co., Ltd, All rights reserved.

CG Triumvirate is a trademark of Agfa Corporation. CG Triumvirate Bold Condensed font is under license from the Monotype Corporation. Windows is a registered trademark of Microsoft Corporation.

All other trademarks are the property of their respective owners.

Information in this document is subject to change without notice and does not represent a commitment on the part of TSC Auto ID Technology Co. No part of this manual may be reproduced or transmitted in any form or by any means, for any purpose other than the purchaser's personal use, without the expressed written permission of TSC Auto ID Technology Co.

Agency Compliance and Approvals



TE200/TE300 Series:

EN 55032, Class A

EN 55024

EN 60950-1

This is a class A product. In a domestic environment this product may cause radio interference in which case the user may be required to take adequate measures.

TE210/TE310 Series:

EN 55032, Class B

EN 55024

EN 61000-3-2

EN 61000-3-3

EN 60950-1

TE200/TE300 Series:

FCC part 15B, Class A

ICES-003, Class A

This equipment has been tested and found to comply with the limits for a Class A digital device, pursuant to Part 15 of the FCC Rules. These limits are designed to provide reasonable protection against harmful interference when the equipment is operated in a commercial environment.

This equipment generates, uses, and can radiate radio frequency energy and, if not installed and used in accordance with the manufacturer's instruction manual, may cause harmful interference with radio communications. Operation of this equipment in a residential area is likely to cause harmful interference, in which case you will be required to correct the interference at your own expense.

This Class A digital apparatus complies with Canadian ICES-003.

Cet appareil numérique de la classe A est conforme à la norme NMB-003 du Canada.



This device complies with Part 15 of the FCC Rules. Operation is subject to the following two conditions: (1) This device may cause harmful interference, and (2) this device must accept any interference received, including interference that may cause undesired operation.

TE210/TE310 Series:

FCC part 15B, Class B

This equipment has been tested and found to comply with the limits for a Class B digital device, pursuant to part 15 of the FCC Rules. These limits are designed to provide reasonable protection against harmful interference in a residential installation. This equipment generates, uses and can radiate radio frequency energy and, if not installed and used in accordance with the instructions, may cause harmful interference to radio communications.

However, there is no guarantee that interference will not occur in a particular installation. If this equipment does cause harmful interference to radio or television reception, which can be determined by turning the equipment off and on, the user is encouraged to try to correct the interference by one or more of the following measures:

- Reorient or relocate the receiving antenna.
- Increase the separation between the equipment and receiver.
- Connect the equipment into an outlet on a circuit different from that to which the receiver is connected.
- Consult the dealer or an experienced radio/ TV technician for help.

This device complies with Part 15 of the FCC Rules. Operation is subject to the following two conditions: (1) This device may cause harmful interference, and (2) this device must accept any interference received, including interference that may cause undesired operation.

This Class B digital apparatus complies with Canadian ICES-003
Cet appareil numérique de la classe B est conforme à la norme
NMB-003 du Canada.



TE200/TE300 Series:
AS/NZS CISPR 32, Class A

TE210/TE310 Series:
AS/NZS CISPR 32, Class B



UL 60950-1
CSA C22.2 No. 60950-1-07



EN 60950-1



TE200/TE300 Series:
GB 4943.1
GB 9254, Class A
GB 17625.1

此为 A 级产品，在生活环境中，该产品可能会造成无线电干扰，在这种情况下，可能需要用户对干扰采取切实可行的措施。

TE210/TE310 Series:
GB 4943.1
GB 9254, Class B
GB 17625.1



Energy Star for Imaging Equipment Version 2.0



TP TC 004
TP TC 020



IS 13252(Part 1)/
IEC 60950-1



KN 32
KN 35

Note: There may have certification differences in the series models, please refer to product label for accuracy.

Important safety instructions:

1. Read all of these instructions and keep them for later use.
2. Follow all warnings and instructions on the product.
3. Disconnect the power plug from the AC outlet before cleaning or if fault happened.
Do not use liquid or aerosol cleaners. Using a damp cloth is suitable for cleaning.
4. The mains socket shall be installed near the equipment and easily accessible.
5. The unit must be protected against moisture.
6. Ensure the stability when installing the device, Tipping or dropping could cause damage.
7. Make sure to follow the correct power rating and power type indicated on marking label provided by manufacture.
8. Please refer to user manual for maximum operation ambient temperature.

WARNING:

Hazardous moving parts, keep fingers and other body parts away.

CAUTION:

(For equipment with RTC (CR2032) battery or rechargeable battery pack)

Risk of explosion if battery is replaced by an incorrect type.

Dispose of used batteries according to the Instructions as below.

1. DO NOT throw the battery in fire.
2. DO NOT short circuit the contacts.
3. DO NOT disassemble the battery.
4. DO NOT throw the battery in municipal waste.
5. The symbol of the crossed out wheeled bin indicates that the battery should not be placed in municipal waste.



Caution: The printhead may be hot and could cause severe burns. Allow the printhead to cool.

CAUTION:

Any changes or modifications not expressly approved by the grantee of this device could void the user's authority to operate the equipment.

CE Statement:

This equipment complies with EU radiation exposure limits set forth for an uncontrolled environment. This equipment should be installed and operated with minimum distance 20 cm between the radiator & your body.

All operational modes:

2.4GHz: 802.11b, 802.11g, 802.11n (HT20), 802.11n (HT40)

5GHz: 802.11a,

The frequency, mode and the maximum transmitted power in EU are listed below:

2400 MHz – 2483.5 MHz: 19.88 dBm (EIRP)

5150 MHz – 5250 MHz: 17.51 dBm (EIRP)

5150-5350MHz for Only indoor use

5470-5725MHz for indoor/outdoor use

Restrictions In AZE

National restrictions information is provided below

Frequency Band	Country	Remark
5150-5350MHz	Azerbaijan	No license needed if used indoor and power not exceeding 30mW
5470-5725MHz		

Hereby, TSC Auto ID Technology Co., Ltd. declares that the radio equipment type [Wi-Fi] IEEE 802.11 a/b/g/n is in compliance with Directive 2014/53/EU

The full text of the EU declaration of conformity is available at the following internet address: [http:// www.tscprinters.com](http://www.tscprinters.com)

RF exposure warning (Wi-Fi)

This equipment must be installed and operated in accordance with provided instructions and must not be co-located or operating in conjunction with any other antenna or transmitter. End-users and installers must be providing with antenna installation instructions and transmitter operating conditions for satisfying RF exposure compliance.

SAR Value: 0.736 W/kg

RF exposure warning (For Bluetooth)

The equipment complies with FCC RF exposure limits set forth for an uncontrolled environment.

The equipment must not be co-located or operating in conjunction with any other antenna or transmitter.

Canada, Industry Canada (IC) Notices

This Class B digital apparatus complies with Canadian ICES-003 and RSS-210. Operation is subject to the following two conditions: (1) this device may not cause interference, and (2) this device must accept any interference, including interference that may cause undesired operation of the device.

Radio Frequency (RF) Exposure Information

The radiated output power of the Wireless Device is below the Industry Canada (IC) radio frequency exposure limits. The Wireless Device should be used in such a manner such that the potential for human contact during normal operation is minimized.

This device has been evaluated for and shown compliant with the IC Specific Absorption Rate ("SAR") limits when installed in specific host products operated in portable exposure conditions. **(For Wi-Fi)**

This device has also been evaluated and shown compliant with the IC RF Exposure limits under portable exposure conditions. (Antennas are less than 20 cm of a person's body). **(For Bluetooth)**

Canada, avis de l'Industry Canada (IC)

Cet appareil numérique de classe B est conforme aux normes canadiennes ICES-003 et RSS-210.

Son fonctionnement est soumis aux deux conditions suivantes : (1) cet appareil ne doit pas causer d'interférence et (2) cet appareil doit accepter toute interférence, notamment les interférences qui peuvent affecter son fonctionnement.

Informations concernant l'exposition aux fréquences radio (RF)

La puissance de sortie émise par l'appareil sans fil est inférieure à la limite d'exposition aux fréquences radio de l'Industry Canada (IC). Utilisez l'appareil sans fil de façon à minimiser les contacts humains lors du fonctionnement normal.

Ce périphérique a été évalué et démontré conforme aux limites SAR (Specific Absorption Rate – Taux d'absorption spécifique) par l'IC lorsqu'il est connecté à des dispositifs hôtes spécifiques opérant dans des conditions d'utilisation mobile. **(Pour le Wi-Fi)**

Ce périphérique a également été évalué et démontré conforme aux limites d'exposition radio-fréquence par l'IC pour des utilisations par des opérateurs mobiles (les antennes sont à moins de 20 cm du corps d'une personne). **(Pour le Bluetooth)**

NCC 警語:

經型式認證合格之低功率射頻電機，非經許可，公司、商號或使用者均不得擅自變更頻率、加大功率或變更原設計之特性及功能。(即低功率電波輻射性電機管理辦法第十二條)

低功率射頻電機之使用不得影響飛航安全及干擾合法通信；經發現有干擾現象時，應立即停用，並改善至無干擾時方得繼續使用。

前項合法通信，指依電信法規定作業之無線電通信。低功率射頻電機須忍受合法通信或工業、科學及醫療用電波輻射性電機設備之干擾。(即低功率電波輻射性電機管理辦法第十四條)

BSMI Class A 警語:

這是甲類的資訊產品，在居住的環境使用中時，可能會造成射頻 干擾，在這種情況下，使用者會被要求採取某些適當的對策。

Model Name	Resolution	Print Speed
TE200 series	203 dpi	Up to 6 IPS
TE300 series	300 dpi	Up to 5 IPS

設備名稱 Equipment name：熱轉式/熱感式條碼印表機，
 型號（型式） Type designation (Type)：TE200 系列

單元 Unit	限用物質及其化學符號 Restricted substances and its chemical symbols					
	鉛Lead (Pb)	汞Mercury (Hg)	鎘Cadmium (Cd)	六價鉻 Hexavalent chromium (Cr ⁺⁶)	多溴聯苯 Polybrominated biphenyls (PBB)	多溴二苯醚 Polybrominated diphenyl ethers (PBDE)
內外塑膠件	○	○	○	○	○	○
內外鐵件	○	○	○	○	○	○
滾輪	○	○	○	○	○	○
電路板組件	-	○	○	○	○	○
晶片電阻	-	○	○	○	○	○
積層陶瓷表面黏著電容	○	○	○	○	○	○
集成電路-IC	○	○	○	○	○	○
電源供應器	○	○	○	○	○	○
印字頭	○	○	○	○	○	○
馬達	-	○	○	○	○	○
插座	○	○	○	○	○	○
線材	○	○	○	○	○	○

備考1. “超出0.1 wt %” 及 “超出0.01 wt %” 係指限用物質之百分比含量超出百分比含量基準值。
 Note 1 : “Exceeding 0.1 wt %” and “exceeding 0.01 wt %” indicate that the percentage content of the restricted substance exceeds the reference percentage value of presence condition.

備考2. “○” 係指該項限用物質之百分比含量未超出百分比含量基準值。
 Note 2 : “○” indicates that the percentage content of the restricted substance does not exceed the percentage of reference value of presence.

備考3. “-” 係指該項限用物質為排除項目。
 Note 3 : The “-” indicates that the restricted substance corresponds to the exemption.

For MFi Bluetooth



Use of the Made for Apple badge means that an accessory has been designed to connect specifically to the Apple product(s) identified in the badge, and has been certified by the developer to meet Apple performance standards. Apple is not responsible for the operation of this device or its compliance with safety and regulatory standards.

For US Model

Made for iPhone®XS Max, iPhone XS, iPhone XR, iPhone X, iPhone 8, iPhone 8 Plus, iPhone 7, iPhone 7 Plus, iPhone SE, iPhone 6s, iPhone 6s Plus, iPhone 6, iPhone 6 Plus, iPhone 5s, iPad Pro® 12.9-inch (2nd generation), iPad Pro 10.5-inch, iPad® (6th generation), iPad (5th generation), iPad Pro 9.7-inch, iPad Pro 12.9-inch (1st generation), iPad Air® 2, iPad mini™ 4, iPad mini 3, iPad Air, iPad mini 2, iPod touch® (6th generation) iPad, iPad Air, iPad Pro, iPhone are trademarks of Apple Inc., registered in the U.S. and other countries.

For JP Model

Made for iPhone XS Max, iPhone XS, iPhone XR, iPhone X, iPhone 8, iPhone 8 Plus, iPhone 7, iPhone 7 Plus, iPhone SE, iPhone 6s, iPhone 6s Plus, iPhone 6, iPhone 6 Plus, iPhone 5s, iPad Pro 12.9-inch (2nd generation), iPad Pro 10.5-inch, iPad (6th generation), iPad (5th generation), iPad Pro 9.7-inch, iPad Pro 12.9-inch (1st generation), iPad Air 2, iPad mini 4, iPad mini 3, iPad Air, iPad mini 2, iPod touch (6th generation) iPad, iPad Air, iPad Pro, iPhone are trademarks of Apple Inc., registered in the U.S. and other countries. The trademark "iPhone" is used in Japan with a license from Aiphone K.K.

Except for US, JP Model

Made for iPhone XS Max, iPhone XS, iPhone XR, iPhone X, iPhone 8, iPhone 8 Plus, iPhone 7, iPhone 7 Plus, iPhone SE, iPhone 6s, iPhone 6s Plus, iPhone 6, iPhone 6 Plus, iPhone 5s, iPad Pro 12.9-inch (2nd generation), iPad Pro 10.5-inch, iPad (6th generation), iPad (5th generation), iPad Pro 9.7-inch, iPad Pro 12.9-inch (1st generation), iPad Air 2, iPad mini 4, iPad mini 3, iPad Air, iPad mini 2, iPod touch (6th generation) iPad, iPad Air, iPad Pro, iPhone are trademarks of Apple Inc., registered in the U.S. and other countries.

Contents

1. Introduction	1
1.1 Product Introduction	1
1.2 Product Features	2
1.2.1 Printer Standard Features	2
1.2.2 Printer Optional Features	3
1.2.3 Label Print Module Features (Optional)	4
1.3 General Specifications	5
1.4 Print Specifications	5
1.5 Ribbon Specifications	6
1.6 Media Specifications	6
2. Operations Overview	7
2.1 Unpacking and Inspection	7
2.2 Printer Overview	8
2.2.1 Front View	8
2.2.2 Interior View	9
2.2.3 Rear View	9
3. Setup	10
3.1 Setting up the Printer	10
3.2 Loading the Ribbon	11
3.3 Loading the Media	14
3.3.1 Loading the Roll Labels	14
3.3.2 External Label Roll Mount Installation (Option)	17
3.3.3 Loading the Media in Cutter mode (TE210/TE310 Series only, dealer option)	19
3.3.4 Loading the Media in Peel-off Mode (TE210/TE310 Series only, dealer option)	21
3.4 Installing the Print Engine (Option)	23
4. LED and Button Functions	24
4.1 LED Indicator	24
4.2 Regular Button Functions	24
4.3 Power-on Utilities	24
4.3.1 Gap/Black Mark Sensor Calibration	25
4.3.2 Gap/Black Mark Calibration, Self-test and Dump Mode	26
4.3.3 Printer Initialization	29

4.3.4 Set Black Mark Sensor as Media Sensor and Calibrate the Black Mark Sensor	30
4.3.5 Set Gap Sensor as Media Sensor and Calibrate the Gap Sensor.....	30
4.3.6 Skip AUTO.BAS	31
5. Diagnostic Tool	32
5.1 Start the Diagnostic Tool	32
5.2 Printer Function	33
5.3 Calibrating Media Sensor by Diagnostic Tool.....	34
5.4 Setting Wi-Fi by Diagnostic Tool (Optional)	35
5.5 Setting Bluetooth by Diagnostic Tool (Optional)	36
6. Troubleshooting.....	37
6.1 Common Problems	37
7. Maintenance	39
Revise History	41

1. Introduction

1.1 Product Introduction

Thank you very much for purchasing TSC bar code printer.

The TE200/TE210/TE300/TE310 series printer features the single motor that is capable of handling a large capacity of 300 meters ribbon and large rolls of media inside its sleek design. If the 5" interior label capacity is not enough, simply add an external media roll mount and the TE series can easily handle 8" OD rolls of labels designed for expensive industrial label printers.

To meet the various printing requirements, TE200/TE300 and TE210/TE310 series provides different memory capacity. Moreover, TE210/TE310 series have optional peel-off and cutter kits for users to purchase. The movable black mark sensor design can accept a wide range of label media. All of the most frequently used bar code formats are included. Fonts and bar codes can be printed in any one of the four directions.

The TE200/TE210/TE300/TE310 series printer is built-in the high quality, high-performance MONOTYPE IMAGING® True Type font engine and one CG Triumvirate Bold Condensed smooth font. With flexible firmware design, user can also download the True Type Font from PC into printer memory for printing labels. Besides the scalable font, it also provides a choice of eight different sizes of the alphanumeric bitmap font. By integrating rich features, it is the most cost-effective and high-performance printer in its class!

To print label formats, please refer to the instructions provided with your labeling software; if you need to write the custom programs, please refer to the TSPL/TSPL2 programming manual that can be found on TSC website at <http://www.tscprinters.com>.

- Applications
 - Manufacturing & Warehousing
 - Work in Progress
 - Item Labels
 - Instruction labels
 - Agency labels
 - Healthcare
 - Patient Identification
 - Pharmacy
 - Specimen Identification
 - Parcel Post
 - Shipping/ Receiving Labels
 - Small Office/ Home Office
 - Retail Marking
 - Price tags
 - Shelf labels
 - Jewelry tags

1.2 Product Features

1.2.1 Printer Standard Features

The printer offers the following standard features.

Product standard feature	TE200 (203 dpi model)	TE300 (300 dpi model)	TE210 (203 dpi model)	TE310 (300 dpi model)
Thermal transfer printing	○	○	○	○
Direct thermal printing	○	○	○	○
Plastic	○	○	○	○
Gap sensor	○	○	○	○
Reflective, full-range moveable black mark sensor	○	○	○	○
Ribbon sensor	○	○	○	○
Head open sensor	○	○	○	○
USB 2.0 (Hi-Speed) interface	○	○	○	○
16 MB DRAM memory	○	○	-	-
64 MB DRAM memory	-	-	○	○
8 MB Flash memory	○	○	-	-
128 MB Flash memory	-	-	○	○
SD card reader (Reserve a PIN connector for updating firmware by card when doing maintenance.)	-	-	-	-
RTC	-	-	○	○
BUZZER	-	-	○	○
One button for feed and pause	○	○	○	○
One LED indicator for 3 colors	○	○	○	○
Standard industry emulations right out of the box including Eltron® and Zebra® language support	○	○	○	○
Internal 8 alpha-numeric bitmap fonts	○	○	○	○
Fonts and bar codes can be printed in any one of the four directions (0, 90, 180, 270 degrees)	○	○	○	○
Internal Monotype Imaging® true type font engine with one CG Triumvirate Bold Condensed scalable font	○	○	○	○
Downloadable fonts from PC to printer memory	○	○	○	○
Downloadable firmware upgrades	○	○	○	○

Text, bar code, graphics/image printing (Please refer to the TSPL/TSPL2 programming manual for supporting code page)

Supported bar code		Supported image				
1D bar code	2D bar code					
Code128UCC, Code128 subsets, A · B · C, EAN128, Interleaved 2 of 5, Interleaved 2 of 5 with check digit, Code39, Code39 with check digit, Code93, EAN13, EAN8, UPCA, UPCE, EAN and UPC 2 (5) digits add-on, Codabar, Postnet, MSI, MSI with check digit, PLESSEY, China post, ITF14, Code11, TELEPEN, TELEPENN, PLANET, Code49, Deutsche Post Identcode, Deutsche Post Leitcode, LOGMARS	GS1 DataBar, GS1, DataMatrix, Maxicode, AZTEC, PDF417, QR Code, Micro PDF 417	BITMAP, BMP, PCX (Max. 256 colors graphics)	<input type="radio"/>	<input type="radio"/>	<input type="radio"/>	<input type="radio"/>

1.2.2 Printer Optional Features

The printer offers the following optional features.

Product option feature	User options	Dealer options	Factory options
Extended plate for external roll mount assembly with 3" core label spindle (8.4 OD)	<input type="radio"/>		
Internal Bluetooth v4.0			<input type="radio"/>
For TE210/TE310 Series only:			
KP-200 Plus (with RS-232 interface)	<input type="radio"/>		
External BT module (with RS-232 interface)	<input type="radio"/>		
Peeler module		<input type="radio"/>	

Regular full cut cutter (Guillotine cutter) Media thickness: 0.06~0.19 mm Media type: receipt and label liner w/o glue		○	
Regular full/partial cutter (Guillotine cutter) Media thickness: 0.06~0.19 mm Media type: receipt and label liner w/o glue		○	
Internal Wi-Fi module			○

Note: 1. Option for either internal Wi-Fi or internal Bluetooth only, not coexistence.

2. Except for the linerless cutter, all TSC regular/heavy duty/care label cutters DO NOT cut on media with glue.

1.2.3 Label Print Module Features (Optional)

Product option feature			
Print Module	Resolution	8 dots/mm (203 DPI)	12 dots/mm (300 DPI)
	Max. print speed	152.4 mm (6")/second	127 mm (5")/second
	Max. print width	108 mm (4.25")	105.7 mm (4.16")
	Physical dimension	196.0 mm (W) x 161.0 mm (L) x 145.0 mm (H) (7.72" (W) x 6.34" (L) x 5.71" (H))	
	Weight	1.43 kg (3.15 lbs)	
Platform	Memory	128 MB Flash memory, 64 MB SDRAM	
	Interface	USB2.0, RS-232, Internal Ethernet 10/100 Mbps, USB host	
	Real time clock	Option	
	Buzzer	Standard	
Power Supply	Input	AC 100-240V, 2.5A, 50-60Hz	
	Output	DC 24V, 2.5A, 60W	
Supported Media	Media type	Continuous, black mark, die-cut, notched, fan-fold	
	Media wound type	Outside wound	
	Media width	20 ~ 112 mm (0.8" ~ 4.4")	
	Min. media length	5 mm (0.2")	
	Media thickness	0.06mm ~ 0.19 mm (2.36 ~ 7.48 mil)	
Support Ribbon	Ribbon type	WAX, RESIN, WAX-RESIN	
	Wound type	Outside wound	
	Ribbon width	40 ~ 110 mm (1.6" ~ 4.3")	
	Ribbon capacity	300 m long, max. OD 67 mm, 1" core (ink coated outside) 110 m long, max. OD 40 mm, 0.5" core (ink coated outside)	
Accessory	Standard	<ul style="list-style-type: none"> ■ 1" label spindle, fixing tab x 2, 1.5" adapter x 2 ■ 1" ribbon spindle x 2 for 300M ribbon ■ 1" ribbon paper core 	

	Optional	<ul style="list-style-type: none"> ■ Peel-off module ■ Guillotine cutter (full cut and partial cut) ■ External roll mount, media OD. 214 mm (8.4") with 76.2 mm (3") core
--	----------	--

1.3 General Specifications

General Specifications	TE200/TE300	TE210/TE310
Physical dimensions	204 mm (W) x 164 mm (H) x 280 mm (L)	
Weight	2.4kg	2.5kg
Electrical	External universal switching power supply Input: AC 100-240V, 2A, 50-60 Hz Output: DC 24V, 2.5A, 60W, LPS	
Environmental condition	Operation: 5 ~ 40°C (41 ~ 104°F), 25~85% non-condensing Storage: -40 ~ 60 °C (-40 ~ 140°F), 10~90% non-condensing	

1.4 Print Specifications

Print Specifications	TE200 (203 dpi model)	TE300 (300 dpi model)	TE210 (203 dpi model)	TE310 (300 dpi model)
Print head resolution	203 dots/inch (8 dots/mm)	300 dots/inch (12 dots/mm)	203 dots/inch (8 dots/mm)	300 dots/inch (12 dots/mm)
Printing method	Thermal transfer and direct thermal			
Dot size (width x length)	0.125 x 0.125 mm (1 mm = 8 dots)	0.084 x 0.084 mm (1 mm = 11.8 dots)	0.125 x 0.125 mm (1 mm = 8 dots)	0.084 x 0.084 mm (1 mm = 11.8 dots)
Print speed (inches per second)	Up to 6 ips	Up to 5 ips	Up to 6 ips	Up to 5 ips
Print speed for peel mode	N/A		Up to 3 ips	
Max. print width	108 mm (4.25")	105.7 mm (4.16")	108 mm (4.25")	105.7 mm (4.16")
Max. print length	2,794 mm (110")	1,016 mm (40")	25,400 mm (1000")	11,430 mm (450")

1.5 Ribbon Specifications

Ribbon Specifications	
Ribbon outside diameter	1" core: Max. 67mm
	0.5" core: Max. 40mm
Ribbon length	1" inner core: 300 meters
	0.5" inner core: 110 meters
Ribbon core inside diameter	0.5 and 1 inch
Ribbon width	40 ~ 110 mm
Ribbon wound type	Outside wound

1.6 Media Specifications

Media Specifications	TE200 (203 dpi model)	TE300 (300 dpi model)	TE210 (203 dpi model)	TE310 (300 dpi model)
Label roll capacity	Max. 5" OD			
Media type	Continuous, die-cut, black mark, fan-fold, notch			
Media wound type	Outside wound			
Media width	20mm ~ Max. 112 mm			
Media thickness	0.06 mm (2.36 mil) ~ 0.19 mm (7.48 mil)			
Media core diameter	1" (25.4 mm) & 1.5" (38 mm) ID core			
Label length	5 mm ~ Max. printing length			
Label length (peeler mode)	N/A		1" ~ 6" (25.4 ~ 152.4 mm)	
Label length (cutter mode)	N/A		1" ~ Max. printing length	
Gap height	Min. 2 mm (0.09")			
Black mark height	Min. 2 mm (0.09")			
Black mark width	Min. 8 mm (0.31")			

2. Operations Overview

2.1 Unpacking and Inspection

This printer has been specially packaged to withstand damage during shipping. Please carefully inspect the packaging and printer upon receiving the bar code printer. Please retain the packaging materials in case you need to reship the printer.

Unpacking the printer, the following items are included in the carton.

- One printer unit
- One quick installation guide
- One power cord
- One external universal switching power supply
- One USB interface cable
- A pair of 1" Ribbon spindles for 300M ribbon
- One 1" ribbon paper core
- One label spindle with two fixing tabs and two 1.5" adapters

If any parts are missing, please contact the Customer Service Department of your purchased reseller or distributor.

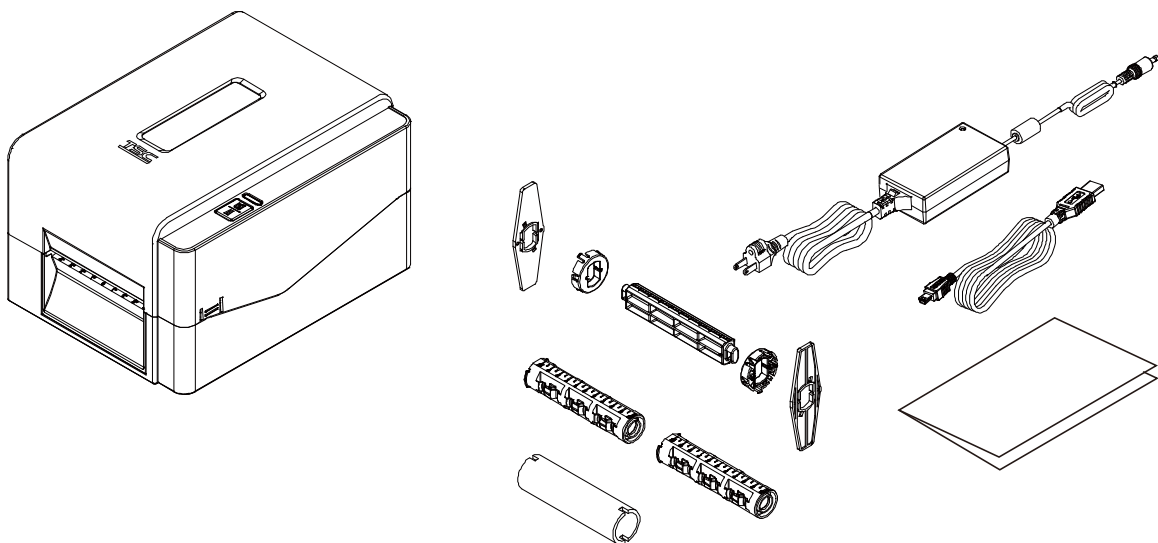

2.2 Printer Overview

2.2.1 Front View



1. LED indicator
2. Feed/Pause button
3. Top cover open tab
4. Paper exit chute

2.2.2 Interior View

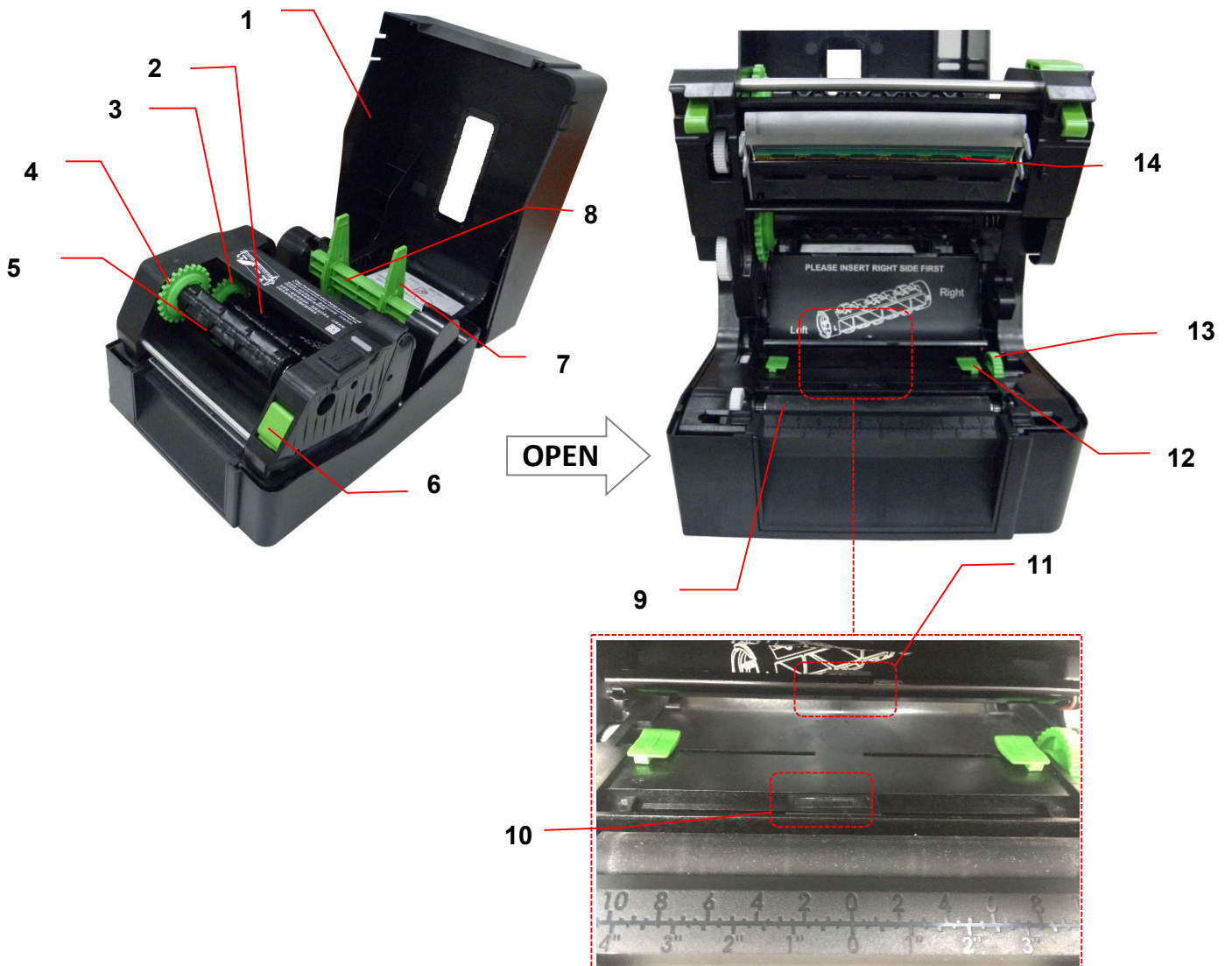

- | | |
|------------------------------|---------------------------------|
| 1. Printer top cover | 8. Media supply spindle |
| 2. Ribbon supply spindle | 9. Platen roller |
| 3. Ribbon supply hub | 10. Black mark sensor |
| 4. Ribbon rewind hub | 11. Gap sensor |
| 5. Ribbon rewind spindle | 12. Media guide |
| 6. Print head release button | 13. Media guide adjustment knob |
| 7. Fixing tabs | 14. Print head |

WARNING
HAZARDOUS MOVING PARTS
KEEP FINGERS AND OTHER
BODY PARTS AWAY

2.2.3 Rear View

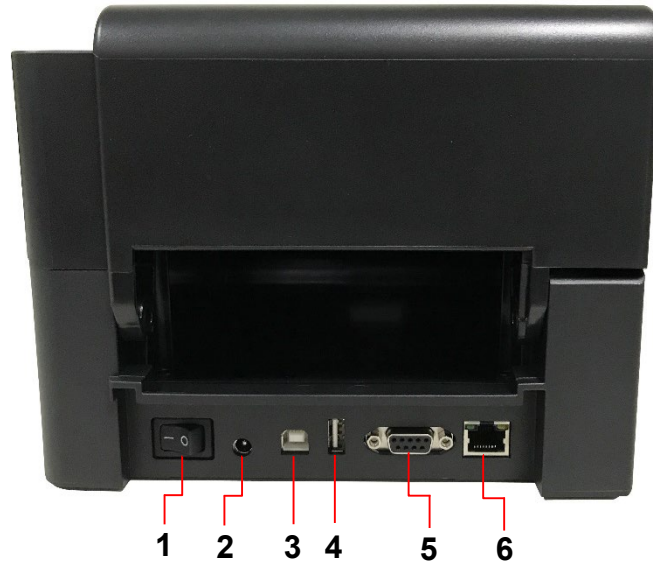

1. Power switch
2. Power jack socket
3. USB interface (USB 2.0/Hi-Speed mode)
4. USB host (TE210/TE310 Series only)
5. RS-232 interface (TE210/TE310 Series only)
6. Ethernet interface (TE210/TE310 Series only)

Note:

The interface picture here is for reference only. Please refer to the product specification for the interfaces availability.

3. Setup

3.1 Setting up the Printer

Place the printer on a flat, secure surface, then follow the steps below:

1. Plug the power cord into the AC power cord socket at the rear of the printer. Then, plug the other side into a properly grounded power outlet.
2. Connect the printer to the computer with the provided USB cable.
3. Push the power switch on “-” side to open the power of printer.
4. If you would like to watch printer installation videos, please scan the QR code on the right side for more information.

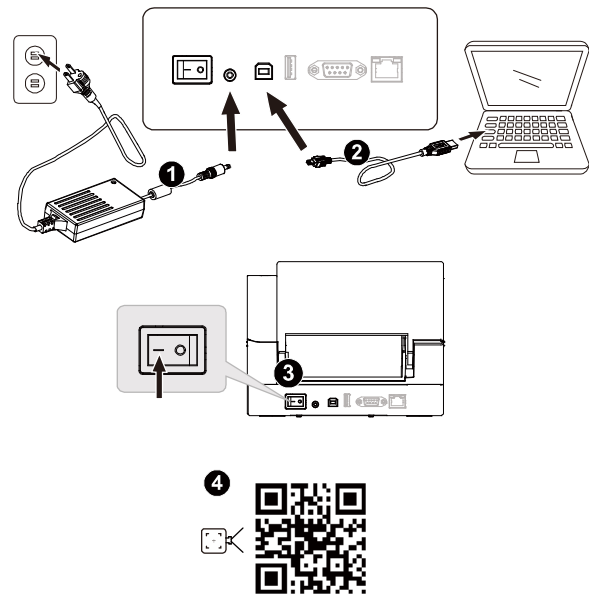

Note:

- * Please switch OFF printer power switch prior to plugging in the power cord to printer power jack.
- * The interface picture here is for reference only. Please refer to the product specification for the interfaces availability.

3.2 Loading the Ribbon



1. Open the printer top cover by pressing the top cover open tabs located on each side of the printer.



2. Insert the paper core to the ribbon rewind spindle.
Note: Please follow the direction when installing the ribbon rewind spindle.

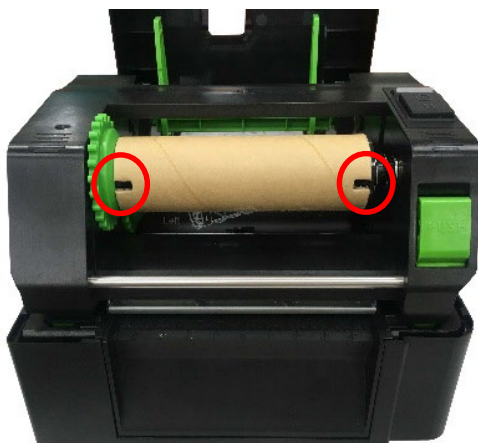

3. Insert the right side of ribbon rewind spindle first. Then, insert the left side to the hole at the left side of ribbon rewind hub (green).

Note:

It can also be substituted by 0.5 or 1 inch paper roll with notches on both sides. Please insert it at the ribbon rewind hub directly.



OPEN

4. Push the print head release button to open the print head mechanism.

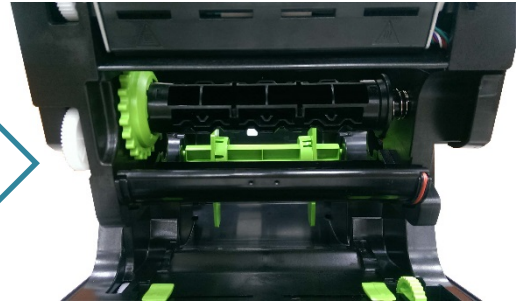

5. Insert the ribbon to the ribbon spindle.

Note: The ribbon spindle can be substituted by insert the ribbon with notches on both sides to the ribbon mechanism directly.



6. Insert the right side of ribbon supply spindle (marked "R") to the ribbon supply hub first. Then, insert the left side of ribbon supply spindle to the hole at the left side of ribbon supply hub (green).

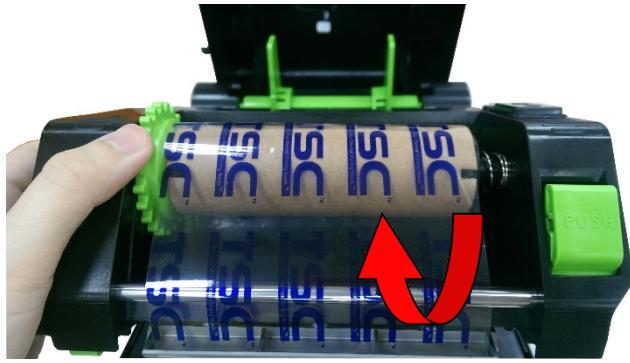

7. Pull the leader of the ribbon through the print head and stick the leader of the ribbon onto the ribbon rewind paper core.
8. Turn the ribbon rewind hub until the ribbon plastic leader is thoroughly wound and the black section of the ribbon covers the print head.

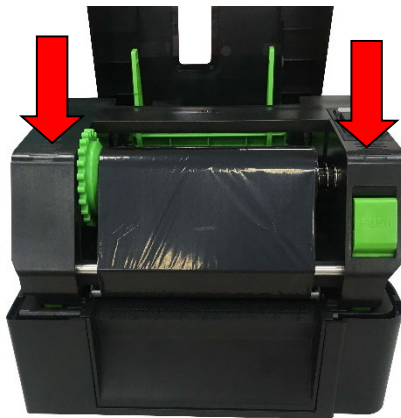

9. Close the print head mechanism with both hands and make sure the latches are engaged securely.

● **Ribbon loading path**

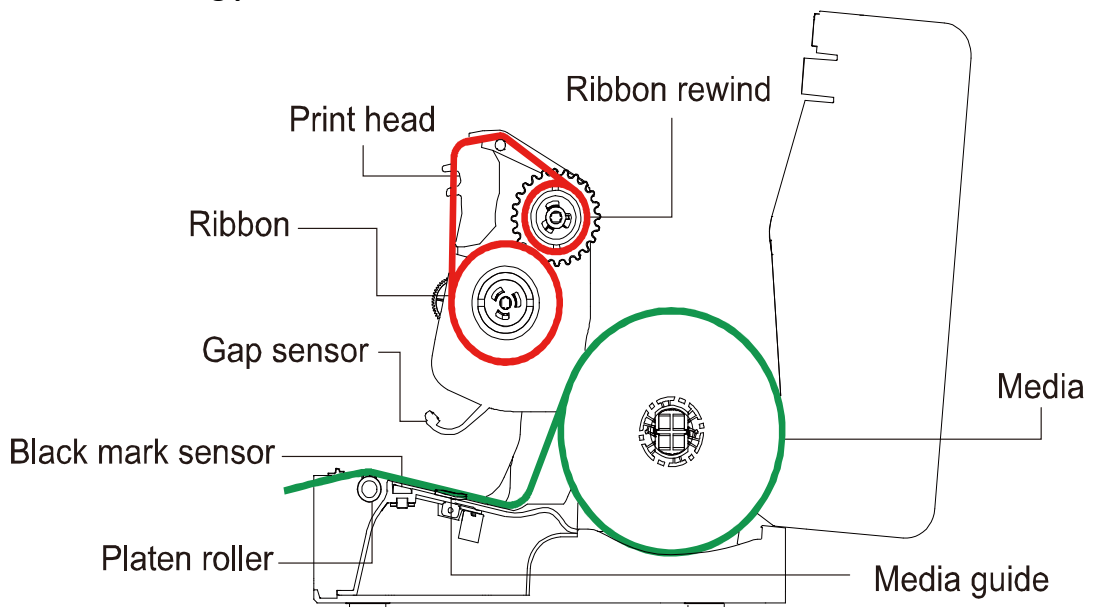

Note:

Please refer to printer installation videos at [TSC YouTube](#).

3.3 Loading the Media

3.3.1 Loading the Roll Labels



1. Open the printer top cover by pressing the top cover open tabs located on each side of the printer.

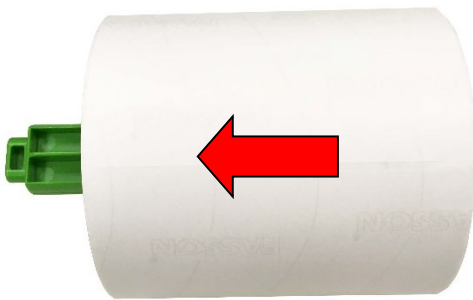

2. Insert the paper roll into the media supply spindle and use two fixing tabs to fix the paper roll onto the center of the spindle. (If your paper width is 4", you can remove the fixing tabs on both side of the media supply spindle.)



3. Place the paper roll onto the paper roll mount.

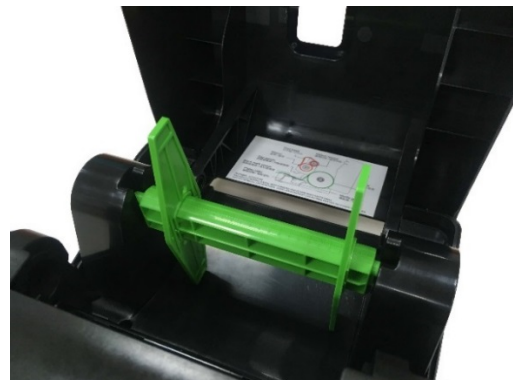
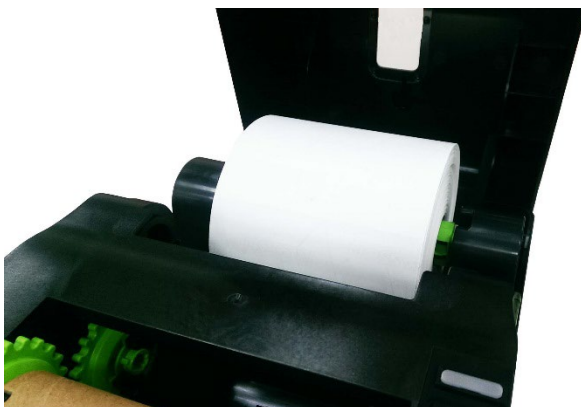

Media spindle attached with two fixing tabs and two 1.5" adapters

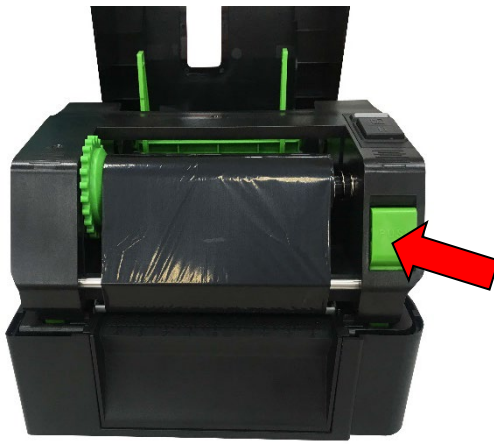

4. Push the print head release button to open the print head mechanism.

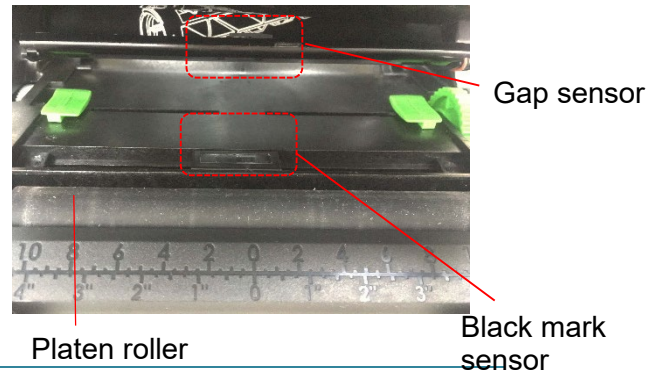

Note: The black mark sensor position is moveable and the gap sensor is fixed. Please make sure the gap or black mark is at the location where media gap/black mark will pass through for sensing.



5. Feed the paper, printing side face up, through the media sensor and place the label leading edge onto the platen roller. Move the media guides to fit the label width.

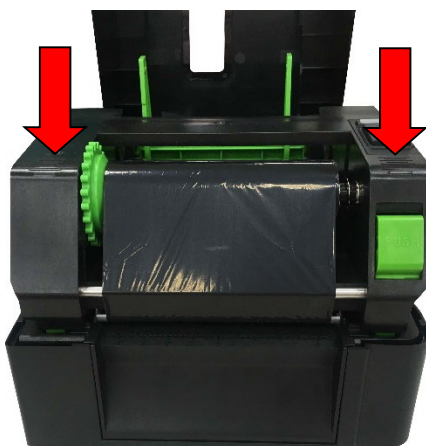

6. Close the print head mechanism with both hands and make sure the latches are engaged securely.

7. Use “Diagnostic Tool” to set the media sensor type and calibrate the selected sensor. (Start the “Diagnostic tool” → Select the “Printer Configuration” tab → Click the “Calibrate Sensor” button) Please refer to section 5.3.

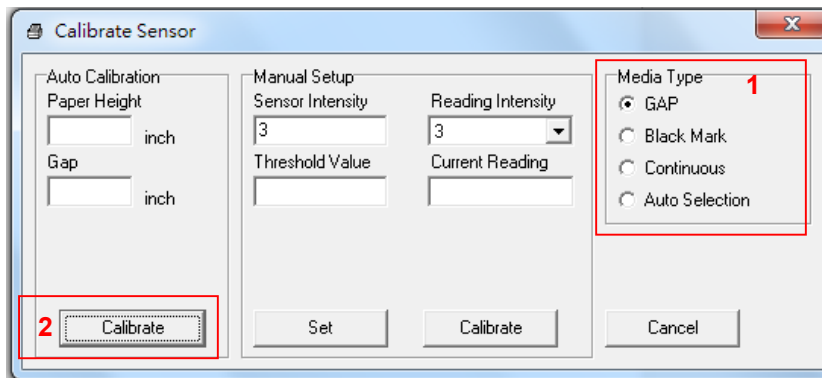

Note:

* Please calibrate the gap/ black mark sensor when changing media.

* Please refer to videos at [TSC YouTube](#).

- **Media Loading path**

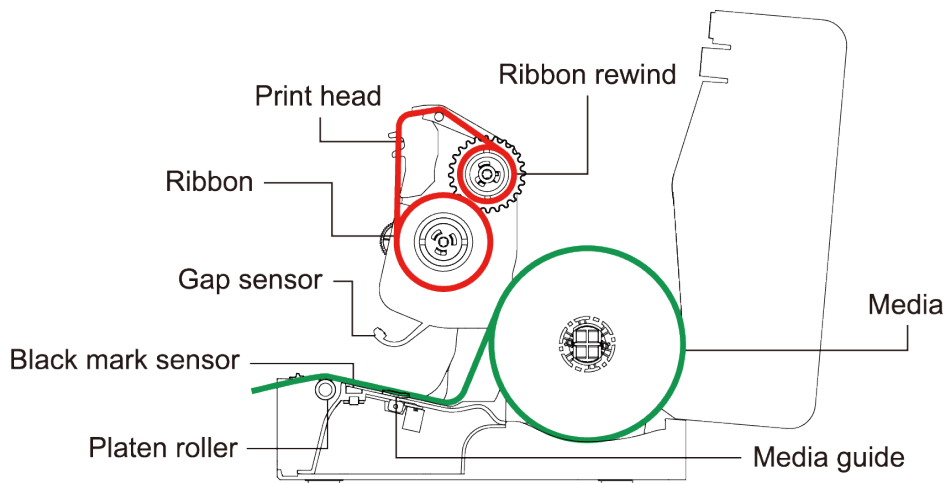

WARNING / ATTENTION
HAZARDOUS MOVING PARTS. KEEP FINGERS AND OTHER BODY PARTS AWAY.
PARTIES MOBILES DANGEREUSES. TENIR LES DOIGTS ET LES AUTRES PARTIES DU CORPS ÉLOIGNÉS.

3.3.2 External Label Roll Mount Installation (Option)

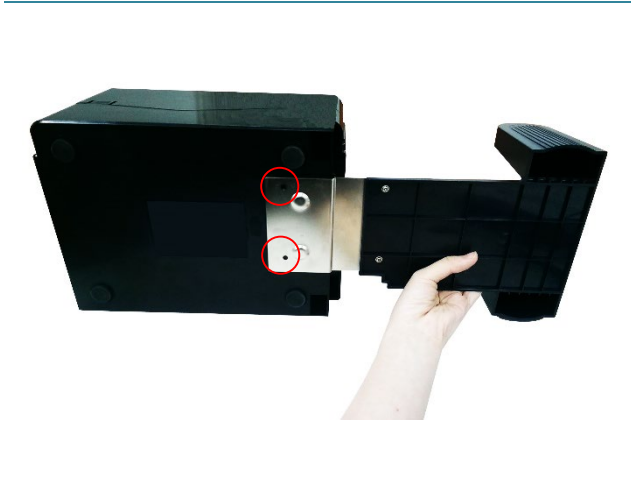

1. Attach the extended plate on the bottom of the printer.



2. Insert a 3" (or 1") label spindle into a paper roll. Then, install it on the external paper roll mount.



3. Feed the media through the rear external label entrance chute.



4. Refer to chapter 3.3.1 to install the label. Use “Diagnostic Tool” to set the media sensor type and calibrate the selected sensor.

Note:

Please calibrate the gap/black mark sensor when changing media.

3.3.3 Loading the Media in Cutter mode (TE210/TE310 Series only, dealer option)



1. Refer to chapter 3.3.1 to install the label. Use “Diagnostic Tool” to set the media sensor type and calibrate the selected sensor.
2. Open the printer top cover by pressing the top cover open tabs located on each side of the printer.



3. Push the print head release button to open the print head mechanism and feed the media through the media sensor. Move the media guides to fit the label width.

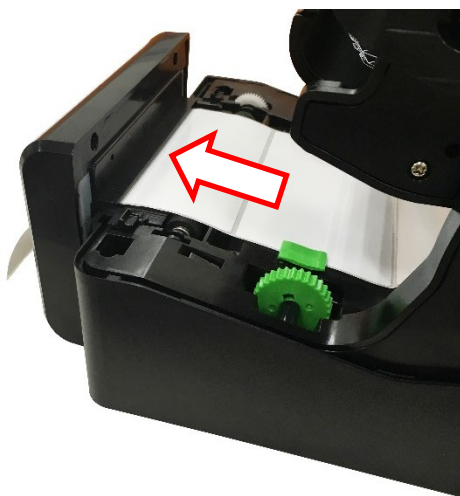

4. Lead the media through the cutter paper opening.



5. Close the print head mechanism as indicated.



6. Close the printer cover. Use the “Diagnostic Tool” to set the printer for cutter mode by selecting “CUTTER” option for Post-Print Action setting then click “Set” button to enable the cutter mode. Press the FEED button to test.

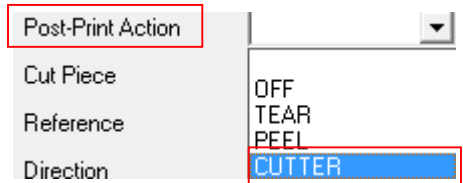

Note:

Please calibrate the gap/black mark sensor when changing media.

3.3.4 Loading the Media in Peel-off Mode (TE210/TE310 Series only, dealer option)



1. Refer to chapter 3.3.1 to install the label. Use “Diagnostic Tool” to set the media sensor type and calibrate the selected sensor.
2. Open the printer top cover by pressing the top cover open tabs located on each side of the printer.



3. Push the print head release button to open the print head mechanism and feed the media through the media sensor. Move the media guides to fit the label width.

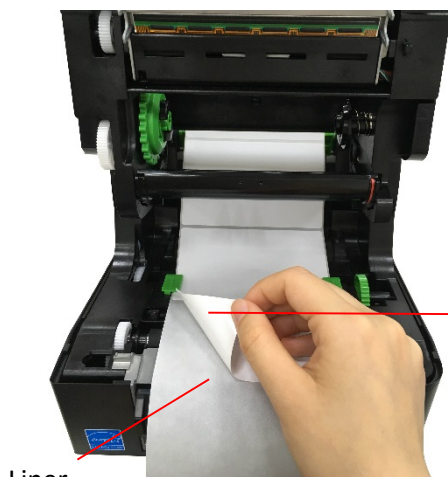

4. Pull the label through the front of the printer and take some labels off only leave the liner.

Label

Liner

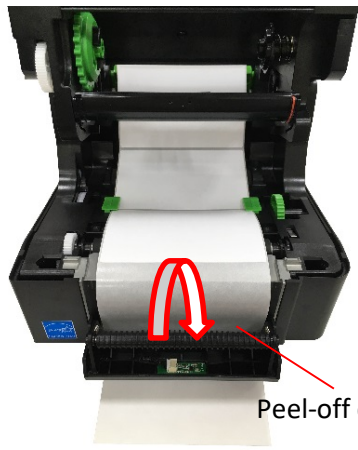

Peel-off cover slot

5. Open the peel-off cover. Feed the liner into peel-off cover slot.



6. Close the peel-off module. Use the "Diagnostic Tool" to set the peel-off mode by selecting "PEEL" option for Post-Print Action setting then click "Set" button to enable the peel-off mode.

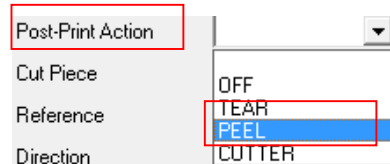

7. Close the media cover and complete peeler module installation.

Note:

The peeler module only support plain paper.

3.4 Installing the Print Engine (Option)



1. Refer to chapter 3.3.1 to install the label. Use “Diagnostic Tool” to set the media sensor type and calibrate the selected sensor.
2. Open the printer top cover by pressing the top cover open tabs located on each side of the printer.

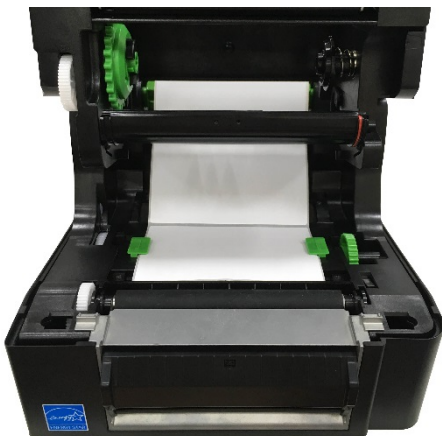

3. Push the print head release button to open the print head mechanism and feed the media through the media sensor. Move the media guides to fit the label width.

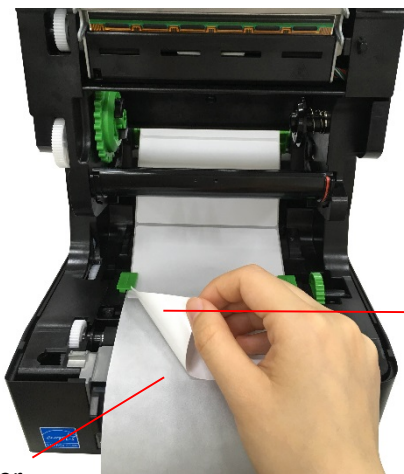

Liner

Label

5. Pull the label through the front of the printer and take some labels off only leave the liner.

4. LED and Button Functions

This printer has one button and one three-color LED indicator. By indicating the LED with different color and pressing the button, printer can feed labels, pause the printing job, select and calibrate the media sensor, print printer self-test report, reset printer to defaults (initialization). Please refer to the button operation below for different functions.

4.1 LED Indicator

LED Color	Description
Green/Solid	This illuminates that the power is on and the device is ready to use.
Green/Flash	This illuminates that the system is downloading data from PC to memory or the printer is paused.
Amber	This illuminates that the system is clearing data from printer.
Red/Solid	This illuminates printer head open, cutter error.
Red/Flash	This illuminates a printing error, such as head open, paper empty, paper jam, ribbon empty, or memory error etc.

4.2 Regular Button Functions

1. Feed labels

When the printer is at ready states (Green/Solid), press the button to feed one label to the beginning of next.

2. Pause the printing job

When the printer is at printing states, press the button to pause a print job. When the printer is paused the LED will be green blinking. Press the button again to continue the printing job.

4.3 Power-on Utilities

There are six power-on utilities to set up and test printer hardware. These utilities are activated by pressing FEED button then turning on the printer power simultaneously and release the button at different color of LED.

Please follow the steps below for different power-on utilities.

1. Turn off the printer power switch.
2. Hold on the button then turn on the power switch.
3. Release the button when LED indicates with different color for different functions.

<i>Power on utilities</i>	The LED color will be changed as following pattern:						
<i>LED color</i>	Amber	Red (5 blinks)	Amber (5 blinks)	Green (5 blinks)	Green/Amber (5 blinks)	Red/Amber (5 blinks)	Solid green
<i>Functions</i>							
1. Gap / black mark sensor calibration		<i>Release</i>					
2. Gap / black mark sensor calibration, Self-test and enter dump mode			<i>Release</i>				
3. Printer initialization				<i>Release</i>			
4. Set black mark sensor as media sensor and calibrate the black mark sensor					<i>Release</i>		
5. Set gap sensor as media sensor and calibrate the gap sensor						<i>Release</i>	
6. Skip AUTO.BAS							<i>Release</i>

4.3.1 Gap/Black Mark Sensor Calibration

Gap/black mark sensor sensitivity should be calibrated at the following conditions:

1. A brand new printer
2. Change label stock
3. Printer initialization

Please follow the steps below to calibrate the ribbon and gap/black mark sensor.

1. Turn off the power switch.
2. Hold on the button then turn on the power switch.
3. Release the button when LED becomes **red** and blinking. (Any red will do during the 5 blinks).

- It will calibrate the ribbon sensor and gap/black mark sensor sensitivity.
- The LED color will be changed as following order :
Amber → **red (5 blinks)** → amber (5 blinks) → green (5 blinks) → green/amber (5 blinks)
→ red/amber (5 blinks) → solid green

Note:

Please select gap or black mark sensor by sending **GAP** or **BLINE** command to printer prior to calibrate the sensor.

For more information about **GAP** and **BLINE** command, please refer to TSPL/TSPL2 programming manual.

4.3.2 Gap/Black Mark Calibration, Self-test and Dump Mode

While calibrate the gap/black mark sensor, printer will measure the label length, print the internal configuration (self-test) on label and then enter the dump mode. To calibrate gap or black mark sensor, depends on the sensor setting in the last print job.

Please follow the steps below to calibrate the sensor.

1. Turn off the power switch.
2. Hold on the button then turn on the power switch.
3. Release the button when LED becomes **amber** and blinking. (Any amber will do during the 5 blinks)

- The LED color will be changed as following order.
Amber → red (5 blinks) → **amber (5 blinks)** → green (5 blinks) → green/amber (5 blinks)
→ red/amber (5 blinks) → solid green

4. It calibrates the sensor and measures the label length and prints internal settings then enter the dump mode.

Note:

Please select gap or black mark sensor by Diagnostic Tool or by GAP or BLINE command prior to calibrate the sensor.

For more information about GAP and BLINE command, please refer to TSPL/TSPL2 programming manual.

■ Self-test

Printer will print the printer configuration after gap/black mark sensor calibration. Self-test printout can be used to check if there is any dot damage on the heater element, printer configurations and available memory space.

Self-test printout	
<pre> ----- SYSTEM INFORMATION ----- MODEL: XXXXXX FIRMWARE: X.XX CHECKSUM: XXXXXXXX S/N: XXXXXXXXXXXX TCF: NO DATE: 1970/01/01 TIME: 00:04:18 NON-RESET: 110 m (TPH) RESET: 110 m (TPH) NON-RESET: 0 (CUT) RESET: 0 (CUT) ----- </pre>	<ul style="list-style-type: none"> Model name F/W version Firmware checksum Printer S/N TSC configuration file System date System time Printed mileage (meter) Cutting counter
<pre> ----- PRINTING SETTING ----- SPEED: 5 IPS DENSITY: 8.0 WIDTH: 4.00 INCH HEIGHT: 4.00 INCH GAP: 0.00 INCH INTENSION: 5 CODEPAGE: 850 COUNTRY: 001 ----- </pre>	<ul style="list-style-type: none"> Print speed (inch/sec) Print darkness Label size (inch) Gap distance (inch) Gap/black mark sensor intension Code page Country code
<pre> ----- Z SETTING ----- DARKNESS: 16.0 SPEED: 4 IPS WIDTH: 4.00 INCH TILDE: 7EH (~) CARET: 5EH (^) DELIMITER: 2CH (,) POWER UP: NO MOTION HEAD CLOSE: NO MOTION ----- </pre>	<ul style="list-style-type: none"> ZPL setting information Print darkness Print speed (inch/sec) Label size Control prefix Format prefix Delimiter prefix Printer power up motion Printer head close motion <p>Note: ZPL is emulating for Zebra® language.</p>
<pre> ----- RS232 SETTING ----- BAUD: 9600 PARITY: NONE DATA BIT: 8 STOP BIT: 1 ----- </pre>	<ul style="list-style-type: none"> RS232 serial port configuration

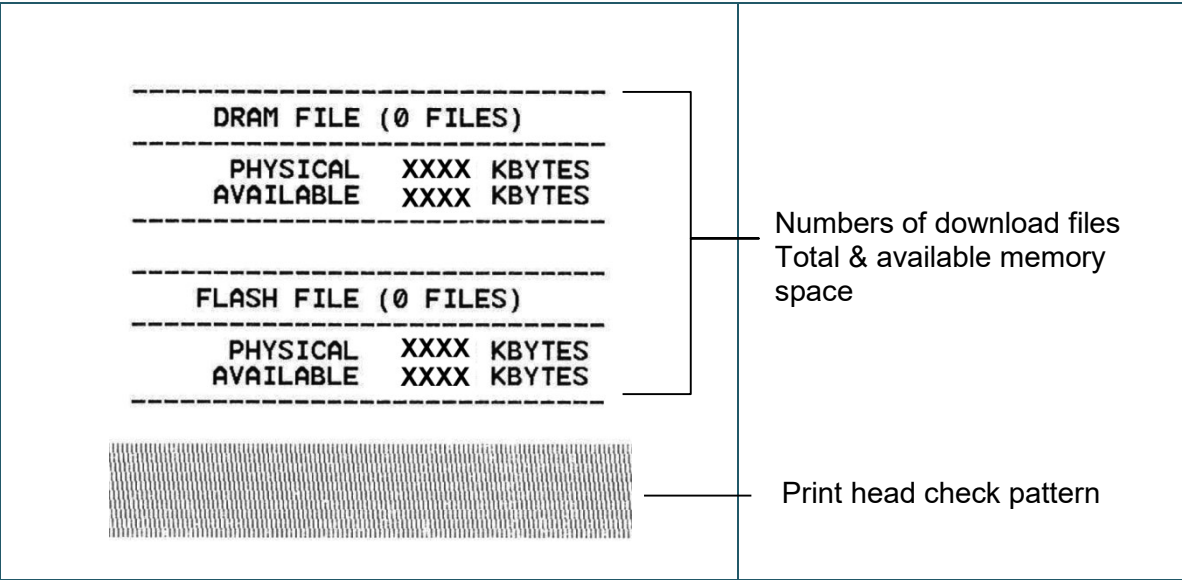

■ Dump mode

Printer will enter dump mode after printing printer configuration. In the dump mode, all characters will be printed in 2 columns as following. The left side characters are received from your system and right side data are the corresponding hexadecimal value of the characters. It allows users or engineers to verify and debug the program.

ASCII Data	→	<pre> SPEED 2.0 53 50 45 45 44 20 32 2E 30 0D DENSITY 8 0A 44 45 4E 53 49 54 59 20 38 SET PEEL 0D 0A 53 45 54 20 50 45 45 4C OFF DIRE 20 4F 46 46 0D 0A 44 49 52 45 CTION 0 0 43 54 49 4F 4E 20 30 0D 0A 47 AP 3.00 mm 41 50 20 33 2E 30 30 20 6D 6D .0.00 mm 2C 30 2E 30 30 20 6D 0D 0A REFERENCE 52 45 46 45 52 45 4E 43 45 20 0.0 SET C 30 2C 30 0D 0A 53 45 54 20 43 UTTER OFF 55 54 54 45 52 20 4F 46 46 0E SIZE 100. 0A 53 49 5A 45 20 31 30 30 2E 02 mm.65.0 30 32 20 6D 6D 2C 36 35 2E 30 4 mm CLS 34 20 6D 6D 0D 0A 43 4C 53 0D BARCODE 1 0A 42 41 52 43 4F 44 45 20 31 44,149,"39 34 34 2C 31 34 39 2C 22 33 39 ".120,1,0. 22 2C 31 32 30 2C 31 2C 30 2C 2.6,"57114 32 2C 36 2C 22 35 37 31 31 34 3BT" PRIN 33 38 54 22 0D 0A 50 52 49 4E T 1.1 SPE 54 20 31 2C 31 0D 0A 53 50 45 ED 2.0 DE 45 44 20 32 2E 30 0D 0A 44 45 NSITY 8 S 4E 53 49 54 59 20 38 0D 0A 53 ET PEEL OF 45 54 20 50 45 45 4C 20 4F 46 F DIRECTI 46 0D 0A 44 49 52 45 43 54 49 ON 0 GAP 4F 4E 20 30 0D 0A 47 41 50 20 3.00 mm.0. 33 2E 30 30 20 6D 6D 2C 30 2E 00 mm REF 30 30 20 6D 6D 0D 0A 52 45 46 ERENCE 0.0 45 52 45 4E 43 45 20 30 2C 30 SET CUTT 0D 0A 53 45 54 20 43 55 54 54 ER OFF S1 45 52 20 4F 46 46 0D 0A 53 49 ZE 100.02 5A 45 20 31 30 30 2E 30 32 20 mm.65.04 m 6D 6D 2C 36 35 2E 30 34 20 6D m CLS BA 6D 0D 0A 43 4C 53 0D 0A 42 41 RCODE 144. 52 43 4F 44 45 20 31 34 34 2C 149,"39",1 31 34 39 2C 22 33 39 22 2C 31 20,1,0,2,0 32 30 2C 31 2C 30 2C 32 2C 36 ".571143BT 2C 22 35 37 31 31 34 33 38 54 " PRINT 1 22 0D 0A 50 52 49 4E 54 20 31 .1 2C 31 0D 0A </pre>	←	Hex decimal data related to left column of ASCII data
------------	---	---	---	---

Note:

1. Dump mode requires 4" wide paper width.
2. Turn off / on the power to resume printer for normal printing.

4.3.3 Printer Initialization

Printer initialization is used to clear DRAM and restore printer settings to defaults.

Printer initialization is activated by the following procedures.

1. Turn off the power switch.
2. Hold on the button then turn on the power switch.
3. Release the button when LED turns **green** after 5 amber blinks. (Any green will do during the 5 blinks).

■ The LED color will be changed as following:

Amber → red (5 blinks) → amber (5 blinks) → **green (5 blinks)** → green/amber (5 blinks) → red/amber (5 blinks) → solid green

Printer configuration will be restored to defaults as below after initialization.

Parameter	Default setting
Speed	127 mm/sec (5 ips) (203DPI) 76 mm/sec (3 ips) (300DPI)
Density	8
Label Width	4" (101.5 mm)
Label Height	4" (101.5 mm)
Sensor Type	Gap sensor
Gap Setting	0.12" (3.0 mm)
Print Direction	0
Reference Point	0,0 (upper left corner)
Offset	0
Tear Mode	On
Peel off Mode	Off
Cutter Mode	Off
Code Page	850
Country Code	001
Clear Flash Memory	No

4.3.4 Set Black Mark Sensor as Media Sensor and Calibrate the Black Mark Sensor

Please follow the steps as below.

1. Turn off the power switch.
2. Hold on the button then turn on the power switch.
3. Release the button when LED turns **green/amber** after 5 green blinks. (Any green/amber will do during the 5 blinks).

- The LED color will be changed as following:
Amber → red (5 blinks) → amber (5 blinks) → green (5 blinks) → **green/amber (5 blinks)**
→ red/amber (5 blinks) → solid green

4.3.5 Set Gap Sensor as Media Sensor and Calibrate the Gap Sensor

Please follow the steps as below.

1. Turn off the power switch.
2. Hold on the button then turn on the power switch.
3. Release the button when LED turns **red/amber** after 5 green/amber blinks. (Any red/amber will do during the 5 blinks).

- The LED color will be changed as following:

Amber → red (5 blinks) → amber (5 blinks) → green (5 blinks) → green/amber (5 blinks) → **red/amber (5 blinks)** → solid green

4.3.6 Skip AUTO.BAS

TSPL2 programming language allows user to download an auto execution file to flash memory. Printer will run the AUTO.BAS program immediately when turning on printer power. The AUTO.BAS program can be interrupted without running the program by the power-on utility.

Please follow the procedures below to skip an AUTO.BAS program.

1. Turn off printer power.
2. Press the FEED button and then turn on power.
3. Release the FEED button when LED becomes **solid green**.

- The LED color will be changed as following:

Amber → red (5 blinks) → amber (5 blinks) → green (5 blinks) → green/amber (5 blinks) → red/amber (5 blinks) → **solid green**

4. Printer will be interrupted to run the AUTO.BAS program.

5. Diagnostic Tool

TSC's Diagnostic Utility is an integrated tool incorporating features that enable you to explore a printer's settings/status; change a printer's settings; download graphics, fonts and firmware; create a printer bitmap font; and send additional commands to a printer. With the aid of this powerful tool, you can review printer status and settings in an instant, which makes it much easier to troubleshoot problems and other issues.

5.1 Start the Diagnostic Tool

1. Double click on the Diagnostic tool icon  `DiagTool.exe` to start the software.
2. There are four features (Printer Configuration, File Manager, Bitmap Font Manager, Command Tool) included in the Diagnostic utility.

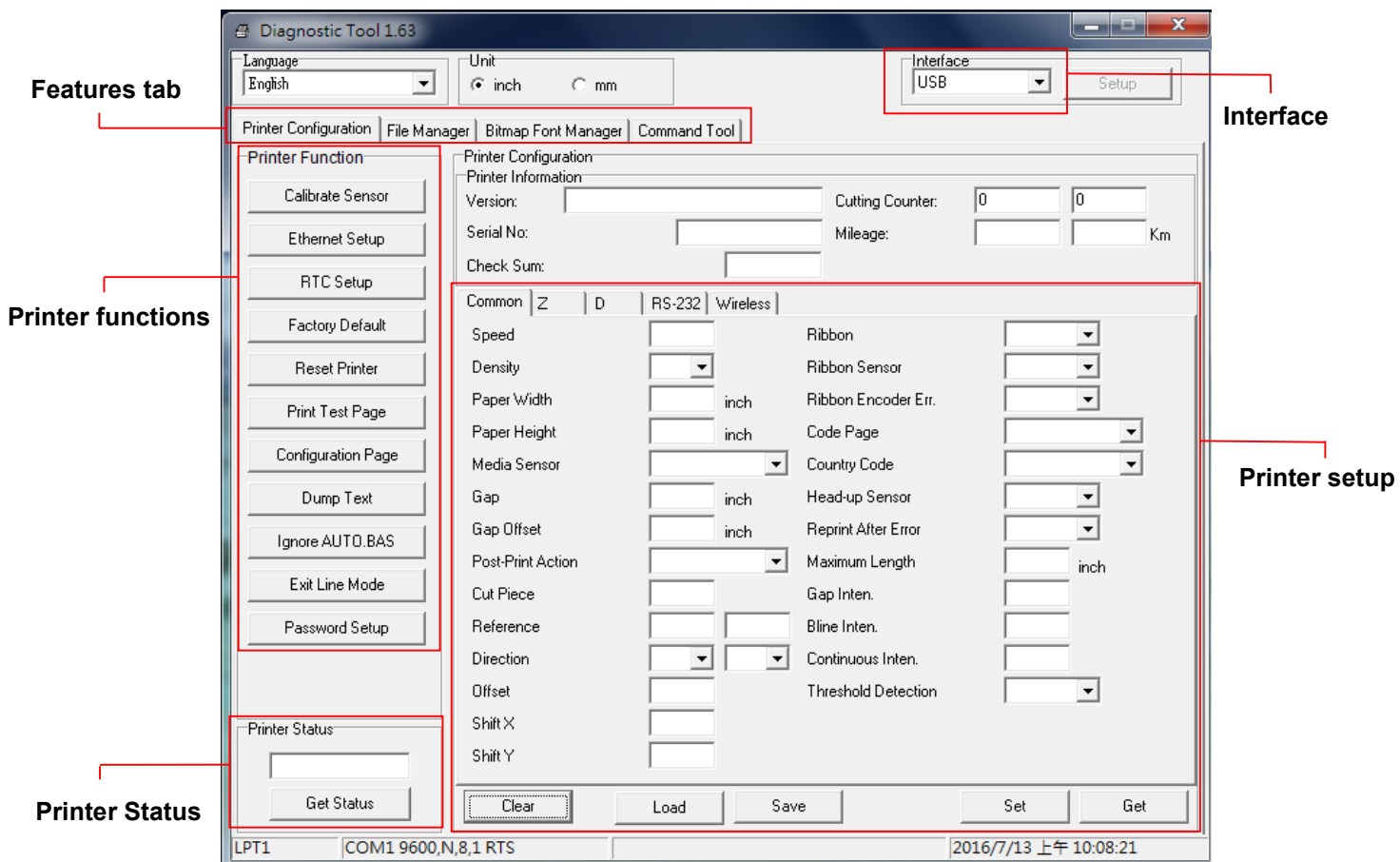

5.2 Printer Function

1. Select the PC interface connected with bar code printer.

The default interface setting is USB interface. If USB interface is connected with printer, no other settings need to be changed in the interface field.

2. Click the “Printer Function” button to setup.
3. The detail functions in the Printer Function Group are listed as below.

	Function	Description
Printer Function		
Calibrate Sensor	Calibrate Sensor	Calibrate the sensor specified in the Printer Setup group media sensor field
Ethernet Setup	Ethernet Setup	Setup the IP address, subnet mask, gateway for the on board Ethernet
RTC Setup	RTC Setup	Synchronize printer Real Time Clock with PC
Print Test Page	Print Test Page	Print a test page
Reset Printer	Reset Printer	Reboot printer
Factory Default	Factory Default	Initialize the printer and restore the settings to factory default. (Please refer section 4.3.3)
Dump Text	Dump Text	To activate the printer dump mode.
Ignore AUTO.BAS	Ignore AUTO.BAS	Ignore the downloaded AUTO.BAS program
Configuration Page	Configuration Page	Print printer configuration (Please refer section 4.3.2)
Password Setup	Password Setup	Set the password to protect the settings

For more information about Diagnostic Tool, please refer to the diagnostic utility quick start guide on [TSC website](#).

5.3 Calibrating Media Sensor by Diagnostic Tool

1. Make sure the media is already installed and print head mechanism is closed. (Please refer to section 3.3.)

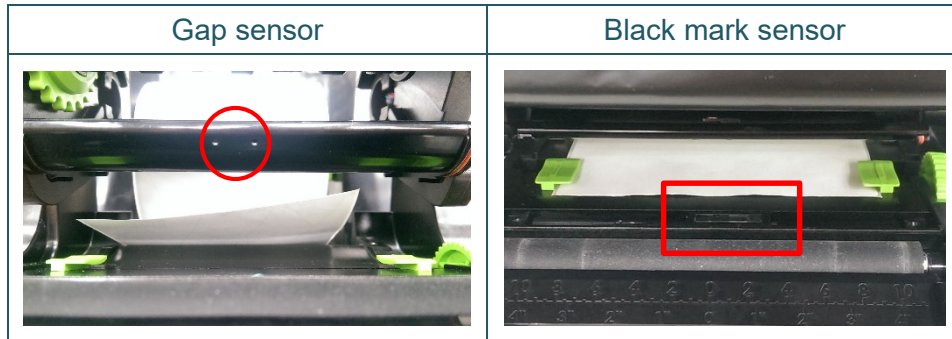

2. Turn on the printer power switch.
3. Open Diagnostic tool and set interface. (The default setting is USB.)

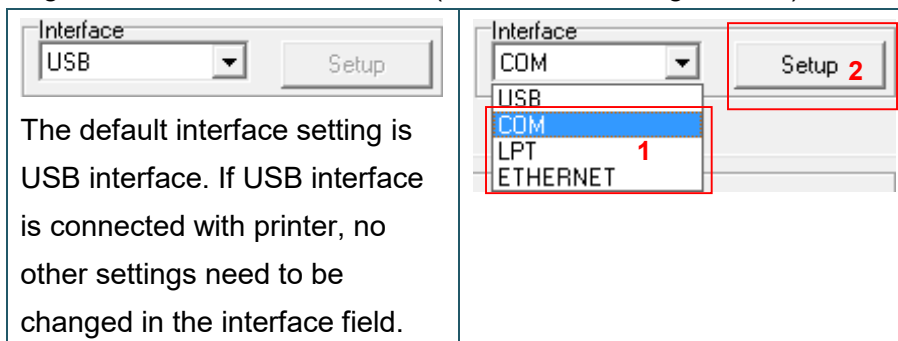

4. Click the “Calibrate Sensor” button.
5. Select the media type and click the “Calibrate” button.

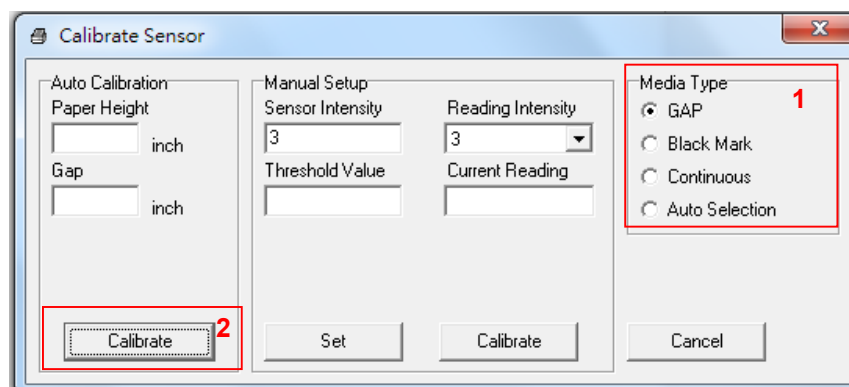

5.4 Setting Wi-Fi by Diagnostic Tool (Optional)

1. Make sure the media is installed ready and media cover is closed.
2. Turn on the printer power switch.
3. Open Diagnostic tool and set interface. (The default setting is USB)

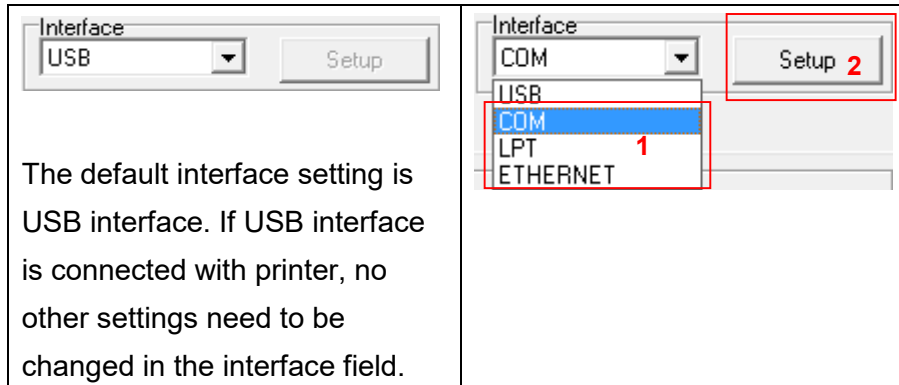

4. Select “Wireless” tab and “Built-in wireless module” item.
5. Enter and select the new WLAN settings in the editor.
6. Press “Set” button to set the new settings to the printer.
7. Press “Get” button to make sure WLAN is set properly.

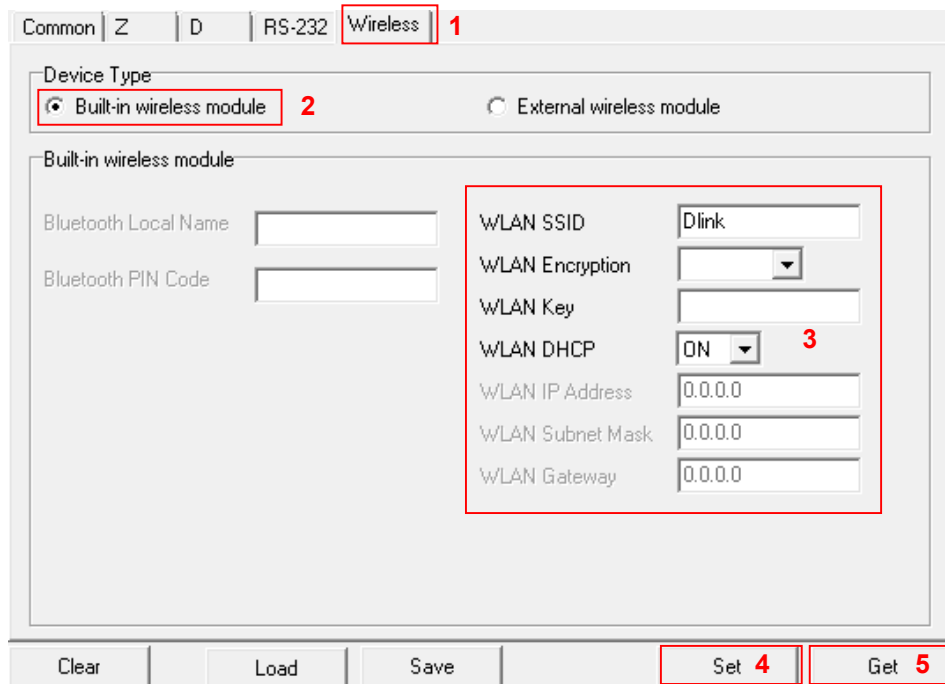

5.5 Setting Bluetooth by Diagnostic Tool (Optional)

1. Make sure the media is installed ready and media cover is closed.
2. Turn on the printer power switch.
3. Open Diagnostic tool and set interface. (The default setting is USB)

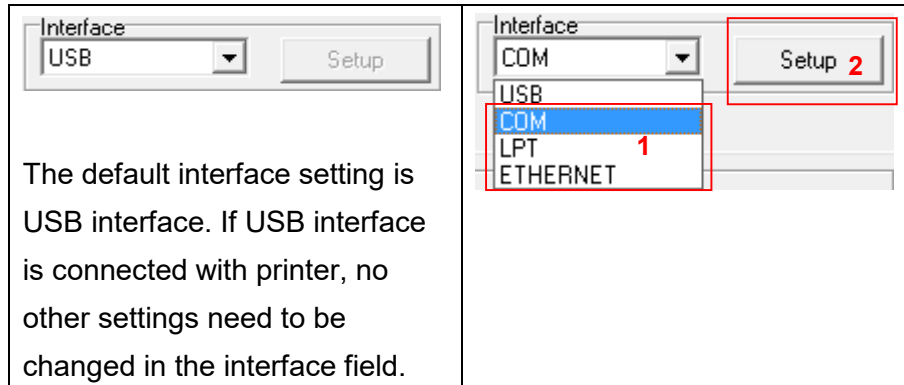

4. Select “Wireless” tab and “Built-in wireless module” item.
5. Enter the new BT Local Name or BT PIN Code in the editor.
6. Press “Set” button to set the new BT name or BT PIN code of the printer.
7. Press “Get” button to get back the settings. Make sure the Bluetooth module settings are set properly.

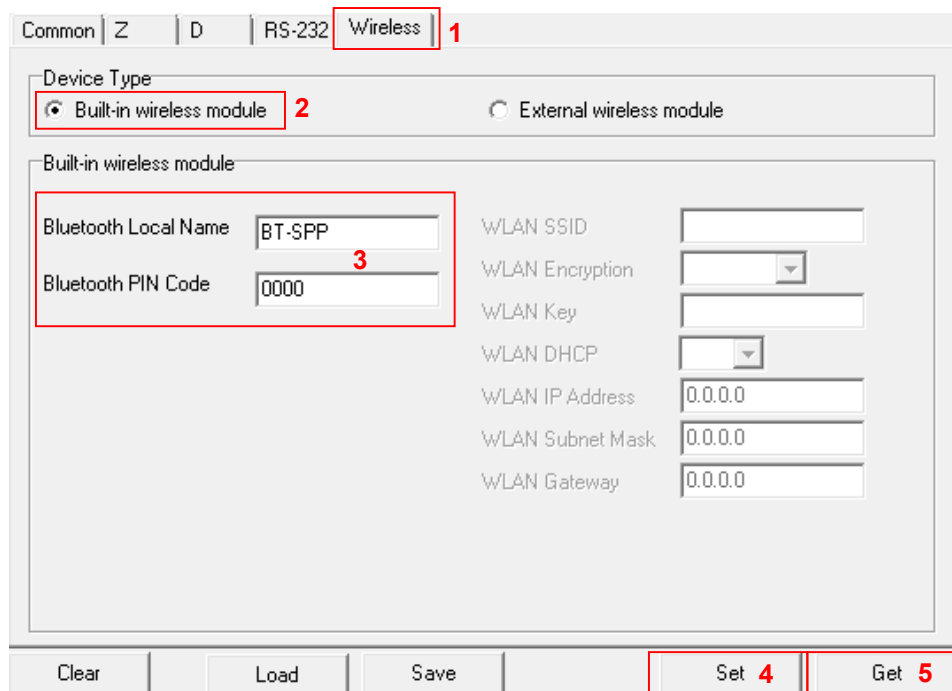

6. Troubleshooting

6.1 Common Problems

The following guide lists the most common problems that may be encountered when operating this bar code printer. If the printer still does not function after all suggested solutions have been invoked, please contact the Customer Service Department of your purchased reseller or distributor for assistance.

Problem	Possible Cause	Recovery Procedure
Power indicator does not illuminate.	* The power cord is not properly connected.	* Plug the power cord in printer and outlet. * Switch the printer on.
- The printer status from DiagTool shows " Head Open ". - The LED shows " Red (solid) ".	* The printer carriage is open.	* Please close the print carriage.
- The printer status from DiagTool shows " Ribbon End Err. " Or " Ribbon Encoder Err. " - The LED shows " Red (blinking) ".	* Running out of ribbon. * The ribbon is installed incorrectly.	* Supply a new ribbon roll. * Please refer to the steps on section 3.2 to re-install the ribbon.
- The printer status from DiagTool shows " Out of Paper ". - The LED shows " Red (blinking) ".	* Running out of label. * The label is installed incorrectly. * Gap/black mark sensor is not calibrated.	* Supply a new label roll. * Please refer to the steps on section 3.3 to reinstall the label roll. * Calibrate the gap/black mark sensor.
- The printer status from DiagTool shows " Paper Jam ". - The LED shows " Red (blinking) ".	* Gap/black mark sensor is not set properly. * Make sure label size is set properly. * Labels may be stuck inside the printer mechanism.	* Calibrate the gap/black mark sensor. * Set label size correctly.
Not Printing	* Cable is not well connected to serial or USB interface or parallel port. * The serial port cable pin configuration is not pin to pin connected.	* Re-connect cable to interface. * Change a new cable. * Ribbon and media are not compatible. * Verify the ribbon-inked side. * Reload the ribbon again. * Clean the print head. * The print density setting is incorrect. * Print head's harness connector is not well connected with printhead. Turn off the printer and plug the connector again. * Check your program if there is a command PRINT at the end of the file and there must have CRLF at the end of each command line.

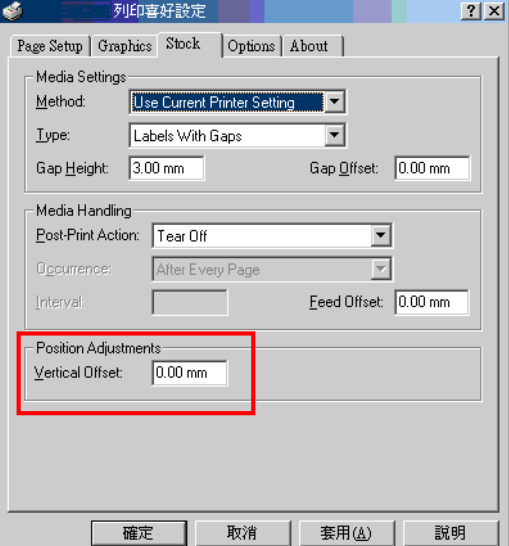
<p>Memory full (FLASH / DRAM)</p>	<p>* The space of FLASH/DRAM is full.</p>	<p>* Delete unused files in the FLASH/DRAM.</p>
<p>Poor Print Quality</p>	<p>* Ribbon and media is loaded incorrectly * Dust or adhesive accumulation on the print head. * Print density is not set properly. * Printhead element is damaged. * Ribbon and media are incompatible.</p>	<p>* Reload the supply. * Clean the print head. * Clean the platen roller. * Adjust the print density and print speed. * Run printer self-test and check the print head test pattern if there is dot missing in the pattern. * Change proper ribbon or proper label media. * The print head mechanism does not latch the print head properly.</p>
<p>Skip labels when printing</p>	<p>* Label size is not specified properly. * Sensor sensitivity is not set properly. * The media sensor is covered with dust.</p>	<p>* Check if label size is setup correctly. * Calibrate the sensor by Auto Gap or Manual Gap options. * Clear the GAP/Black mark sensor by blower.</p>
<p>The printing position of small label is incorrect</p>	<p>* Media sensor sensitivity is not set properly. * Label size is incorrect. * The vertical offset setting in the driver is incorrect.</p>	<p>* Calibrate the sensor sensitivity again. * Set the correct label size and gap size. * If using the software BarTender, please set the vertical offset in the driver.</p> 
<p>Missing printing on the left or right side of label</p>	<p>* Wrong label size setup.</p>	<p>* Set the correct label size.</p>
<p>Wrinkle problem</p>	<p>* Ribbon installation is incorrect. * Media installation is incorrect. * Print density is incorrect. * Media feeding is incorrect.</p>	<p>* Please set the suitable density to have good print quality. * Make sure the label guide touch the edge of the media guide.</p>
<p>Gray line on the blank label</p>	<p>* The print head is dirty. * The platen roller is dirty.</p>	<p>* Clean the print head. * Clean the platen roller.</p>
<p>Irregular printing</p>	<p>* The printer is in Hex Dump mode.</p>	<p>* Turn off and on the printer to skip the dump mode.</p>

7. Maintenance

This session presents the clean tools and methods to maintain your printer.

1. Please use one of following material to clean the printer.

- Cotton swab
- Lint-free cloth
- Vacuum / Blower brush
- 100% ethanol

2. The cleaning process is described as following,

Printer Part	Method	Interval
Print Head	1. Always turn off the printer before cleaning the print head. 2. Allow the print head to cool for a minimum of one minute. 3. Use a cotton swab and 100% ethanol to clean the print head surface.	Clean the print head when changing a new label roll.
Platen Roller	1. Turn the power off. 2. Rotate the platen roller and wipe it thoroughly with 100% ethanol and a cotton swab, or lint-free cloth.	Clean the platen roller when changing a new label roll.
Tear Bar/Peel Bar	Use the lint-free cloth with 100% ethanol to wipe it.	As needed
Sensor	Compressed air or vacuum	Monthly
Exterior	Wipe it with water-dampened cloth	As needed
Interior	Brush or vacuum	As needed

Note:

- Do not touch printer head by hand. If you touch it careless, please use ethanol to clean it.
- Please use 100% Ethenol. DO NOT use medical alcohol, which may damage the printer head.
- Regularly clean the print head and supply sensors once change a new ribbon to keep printer performance and extend printer life.

- The maximum printing ratio per dot line is 15% for this printer. To print the full web black line, the maximum black line height is limited to 40 dots, which is 5mm for 203 DPI resolution printer and 3.3mm for 300 DPI resolution printer.

Revise History

Date	Content	Editor
2018/1/23	Revise Agency Compliance and Approvals	Kate
2019/3/21	Add Ch.7 Maintenance note	Kate
2019/4/24	Revise Ch. 1.2.2 Regular full cut cutter (Guillotine cutter) and Regular full/partial cutter (Guillotine cutter) specification	Kate
2019/5/13	Add notes on Ch.1.2.2	Kate
2019/10/4	Revise CCC certification logo	Kate
2019/11/22	Add Ch.1.2.3 Label Print Module Features (Optional)	Kate
2020/3/20	Add MFi info(BT)	Camille
2020/4/20	-Modify Ch. 1.2.2 -Add Ch.5.4 Setting Wi-Fi by Diagnostic Tool (Optional) Add Ch.5.5 Setting Bluetooth by Diagnostic Tool (Optional)	Camille



TSC Auto ID Technology Co., Ltd.

Corporate Headquarters

9F., No.95, Minquan Rd., Xindian Dist.,
New Taipei City 23141, Taiwan (R.O.C.)

TEL: +886-2-2218-6789

FAX: +886-2-2218-5678

Web site: www.tscprinters.com

E-mail: printer_sales@tscprinters.com

tech_support@tscprinters.com

Li Ze Plant

No.35, Sec. 2, Ligong 1st Rd., Wujie Township,
Yilan County 26841, Taiwan (R.O.C.)

TEL: +886-3-990-6677

FAX: +886-3-990-5577