



Monitor Touch Screen Elo Touch ET3201L

O Elo 3201L proporciona uma experiência única em interatividade. De 32 polegadas, o display de grande formato oferece integradores de sistemas e soluções de alto desempenho para ser empregado no varejo, hotelaria, saúde e no comércio em geral.

www.bztech.com.br



USER MANUAL

Elo Touch Solutions

ET3201L 32" Interactive Digital Signage Touchmonitor

ET4201L 42" Interactive Digital Signage Touchmonitor

ET5501L 55" Interactive Digital Signage Touchmonitor

ET7001L 70" Interactive Digital Signage Touchmonitor

SW601990 Rev H

Copyright © 2014 Elo Touch Solutions, Inc. All Rights Reserved.

No part of this publication may be reproduced, transmitted, transcribed, stored in a retrieval system, or translated into any language or computer language, in any form or by any means, including, but not limited to, electronic, magnetic, optical, chemical, manual, or otherwise without prior written permission of Elo Touch Solutions, Inc.

Disclaimer

The information in this document is subject to change without notice. Elo Touch Solutions, Inc. and its Affiliates (collectively "Elo") makes no representations or warranties with respect to the contents herein, and specifically disclaims any implied warranties of merchantability or fitness for a particular purpose. Elo reserves the right to revise this publication and to make changes from time to time in the content hereof without obligation of Elo to notify any person of such revisions or changes.

Trademark Acknowledgments

AccuTouch, CarrollTouch, Elo, Elo (logo), Elo Touch, Elo Touch Solutions, Elo TouchSystems, IntelliTouch, iTouch, SecureTouch, TouchTools and VuPoint are trademarks of Elo and its Affiliates. Windows is a trademark of Microsoft Corporation.

Table of Contents

Chapter 1 – Introduction.....	4
Chapter 2 – Unpacking.....	5
Chapter 3 – Touchmonitor Installation.....	6
Chapter 4 – Mounting.....	9
Chapter 5 – Operation.....	13
Chapter 6 – Technical Support.....	28
Chapter 7 – Safety & Maintenance.....	29
Chapter 8 – Regulatory Information.....	30
Chapter 9 – Warranty Information.....	35

Chapter 1: Introduction

Product Description

Your new Interactive Digital Signage (IDS) touchmonitor combines Elo Touch Solutions reliable performance with the latest developments in touchscreen technology and display design. This combination of features creates a natural flow of information between a user and the touchmonitor.

This touchmonitor incorporates a 24-bit color, active matrix thin-film-transistor, and digital signage LCD panel to provide superior display performance. Its Full HD resolution of 1920x1080 is suitable for displaying graphics and images. Other features that enhance this LCD monitor's performance are Plug & Play compatibility, built-in speakers and headphone output capability, a remote for on screen display (OSD) controls, and a family of IDS computer modules.

The computer modules are designed to slide into a bay on the rear of the monitor. The monitors form factor will not be affected and extra cabling is not required. Your IDS touchmonitor will turn into an IDS All-in-One touchcomputer.

Precautions

Follow all warnings, precautions and maintenance as recommended in this user manual to maximize the life of your unit and prevent risks to user safety. See Chapter 8 for more information on touchmonitor safety.

For your health and safety, it is strongly recommended that at least two people (four for the ET7001L) handle, lift, and/or move these touchmonitors.

This manual contains information that is important for the proper setup and maintenance of the IDS and optional computer module. Before setting up and powering on your new touchmonitor and computer module, read through this manual, especially the Installation, Mounting, and Operation chapters.

Chapter 2: Unpacking

Unpacking the Interactive Digital Signage Touchmonitor

To unpack the IDS, follow these steps:

1. The carton should be oriented in the manner according to its labeling. The hinged plastic locks should be at the 'bottom'.
2. Open and remove all 4 hinged plastic locks. There are 6 hinged plastic locks for the 7001L unit.

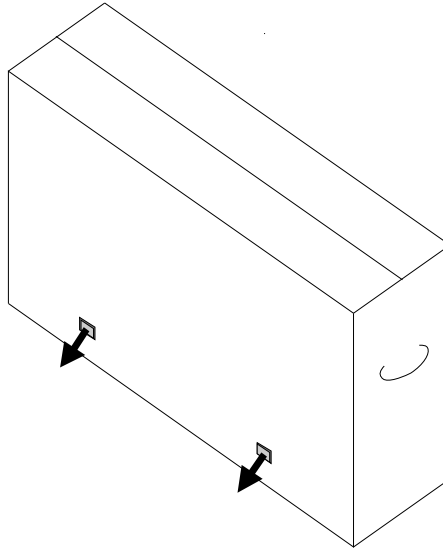

3. Once the locks are removed, lift the cartons top lid off the bottom frame.

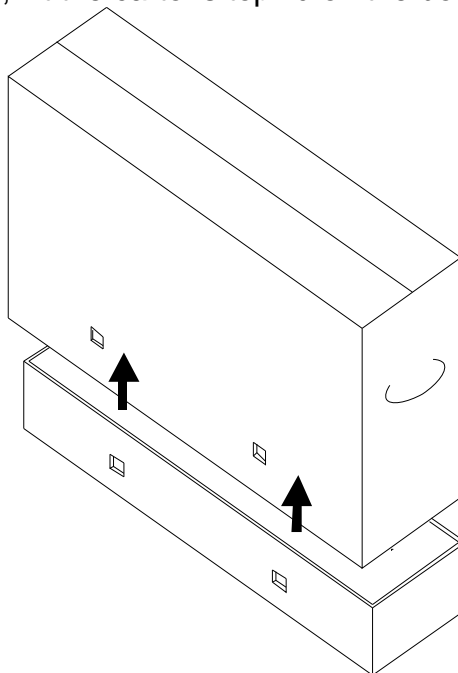

4. With the top lid removed, you now have access to the IDS touchmonitor and the included accessories.

Chapter 3: IDS Touchmonitor Installation

Connector Panel & Interfaces

Note: For your health and safety, it is strongly recommended that at least two people (four for the ET7001L) handle, lift, or move these Touchmonitors. Elo recommends safe lifting techniques as described in OSHA/NIOSH Guidelines.

Check that the following items are present and in good condition:

- IDS touchmonitor
- User Manual CD
- Quick Install Guide
- OSD Remote connected to the monitor
- Cables
 - HDMI, USB, North America power, Europe/Korea power, U.K. power, Argentina power, Taiwan power, China power, Korea power, Japan power, & Japan 3pin-2pin adapter

Remove the cable cover on the bottom rear (when viewed in landscape orientation) to access the touchmonitors connector panel.

Pictures of the connector panel and interfaces. The OSD connection is in red.

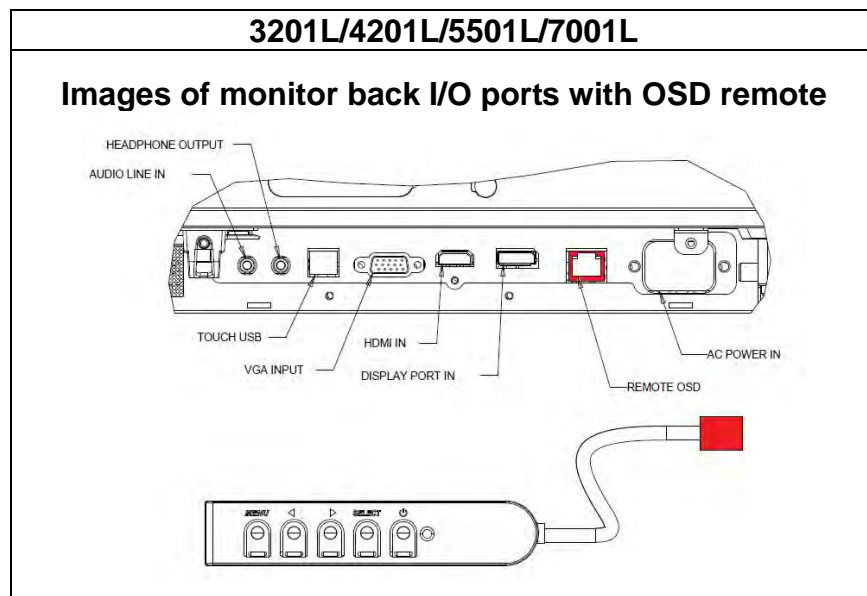

IDS Touchmonitor Connections to an External Computer

1. Connect the HDMI cable between the monitor and the video source.
2. Connect the USB touch cable between the monitor and the PC.
3. Select the correct power cable for your region. Connect it between the AC power source and the touchmonitors POWER IN connector.
4. The touchmonitor ships in an ON state. Use the remote OSD to access the On Screen Display Menu.

Installing the IDS Touchscreen Technology Software Drivers

The Elo touch driver and the Elo Computer Module driver packs are available with the CD that ships with the touchmonitor.

Visit the Elo Touch Solutions website www.elotouch.com for:

- Updates to the Elo touch driver
- Additional touch driver information
- Detailed touch driver installation guides
- Touch drivers for other operating systems

IntelliTouch Plus units are HID compatible, but will require the Elo driver if touch calibration is required.

Optical units are HID compatible and do not require an Elo touch driver. If an Elo touch driver has previously been installed on the host computer, remove this driver by opening Control Panel and selecting to remove the driver completely.

Chapter 4: Mounting

Note: For your health and safety, it is strongly recommended that at least two people (four are recommended for the ET7001L) handle, lift, or move these touchmonitors.

Note: Do **NOT** lay the display face-down as this can cause damage to the monitor.

General Mounting Information

The following three mounting orientations are supported: Landscape, portrait and table-top mode. For optimal touch performance, ensure that the monitor is supported fully and is as flat as possible.

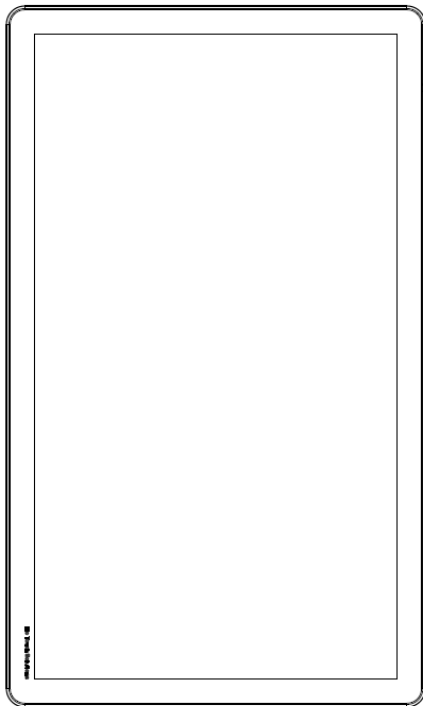

Portrait



Landscape

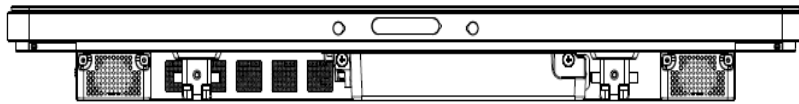

Table Top –Refer to the Temperature Control section for table top mode requirements.

Rear VESA Mount

For the 32" and 42" models:

A four-hole, 400x400mm mounting pattern is provided on the rear of the monitor.

The VESA FDMI-compliant mounting is coded: VESA MOUNT PER MIS-F, 400,400,6MM

For the 55" models:

A four-hole, 600x600mm mounting pattern is provided on the rear of the monitor.

The VESA FDMI-compliant mounting is coded: VESA MOUNT PER MIS-F, 600,600,6MM

For the 70" models:

A four-hole, 400x400mm mounting pattern is provided on the rear of the monitor.

The VESA FDMI-compliant mounting is coded: VESA MOUNT PER MIS-F, 400,400,8MM

Refer to www.elotouch.com for dimensional drawings.

Optional Stand (for 3201L and 4201L Only) Elo PN: E455084

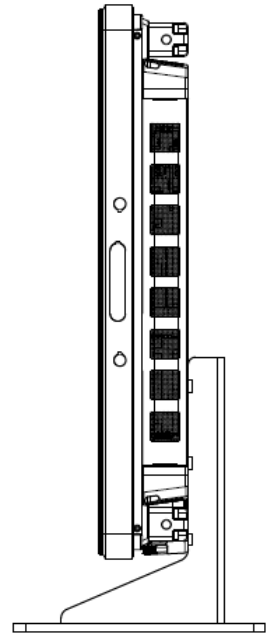
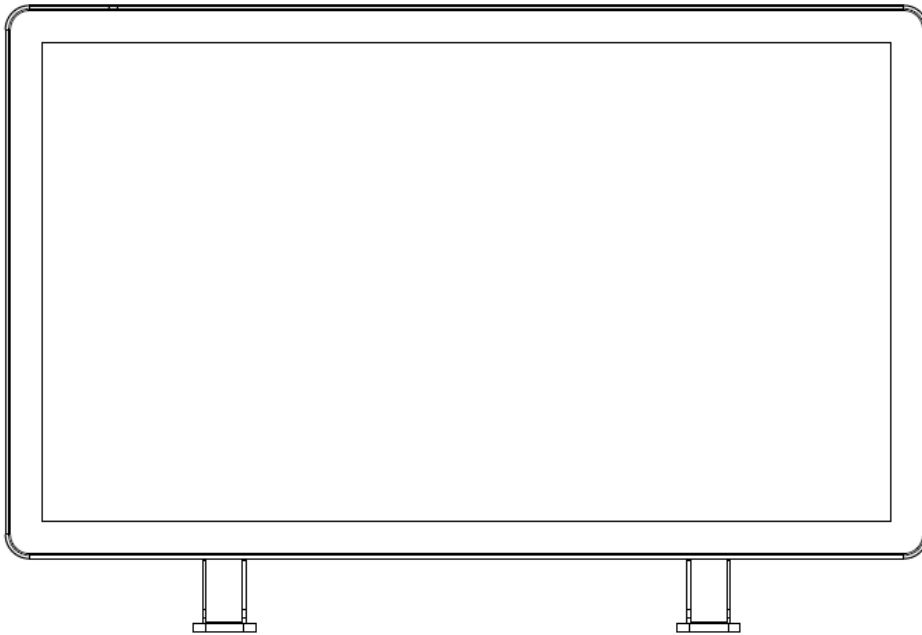

Optional Wall Mounts Kits (detailed information available on the MS drawing for each size):

Consult the wall mount user guide for detailed information located under the Support tab on each IDS touchmonitor size.

Chapter 5: Operation

Power

To turn the touchmonitor on or off, press the touchmonitor power button once. If a computer module is installed, then the computer module will also turn on with the monitor.

To abruptly power off the computer module and touchmonitor, press and hold the touchmonitor power button until the computer shuts off.

To gracefully shut down the computer module, follow the computer modules operating systems normal power off procedure.

A Power Status LED is provided on the OSD Remote that functions according to the following table:

Touchmonitor/Computer Module status	LED status
OFF	OFF
SLEEP	BLINKING
ON	ON

The system consumes low power when in SLEEP and OFF modes. For detailed power consumption specifications, refer to technical specifications available on the Elo website www.elotouch.com.

Touching the screen will bring the system out of MONITOR SLEEP mode.

If long periods of disuse are planned, unplug the AC power cable to save power.

The maximum voltage, frequency and current for the touchmonitor are provided in the power ratings table below:

	Operating Voltage Range	Operating Frequency Range	Operating Current Range
ET32/4201L	100 - 240Vac	50/60 Hz	3.6 – 1.5 A
ET5501L	100 - 240Vac	50/60 Hz	5 – 2.1 A
ET7001L	100 - 240Vac	50/60 Hz	5 – 2.1 A

IntelliTouch Touchscreen Technology

The IntelliTouch and IntelliTouch Plus touchscreens can be re-calibrated to your displayed video image, if needed, through the calibration function in the Elo driver control panel.

IntelliTouch Plus monitors require calibration if the video source is rotated.

Optical Touchscreens Technology

When connected to Windows 7 computers, the touchmonitor can report six simultaneous touches.

Projective Capacitance Touchscreens Technology

When connected to Windows 7 computers, the touchmonitor can report ten simultaneous touches.

Gesturing Images:

For multi-touch monitors, the following gestures are possible:

Single Touch Gestures and their Functions:

Swipe - The ability to swipe through from one picture to another or drag an icon

Dual Touch Gestures and their Functions:

Swipe – The action of moving a finger across the screen.

- The ability to swipe through from one picture to another or drag an icon

Pinch-Zoom - Zoom into a picture

- Place two fingers on the screen and move them closer together to zoom in. Move your fingers away from each other to zoom out.



Before zoom



After zoom

Rotate – A picture can be rotated 360°

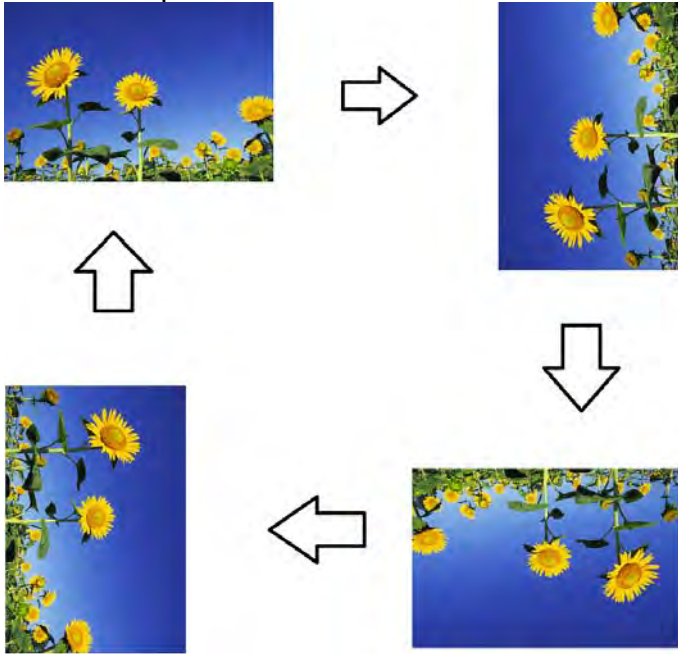

In addition to the above gestures, Optical units have the ability to pinch and zoom three different pictures at the same time because six simultaneous touches are supported.

Video

An LCD panels native resolution is its width and height measured in number of pixels.

In almost all cases, an image displayed on an LCD monitor will look best when your computers output resolution matches the LCD panels native resolution. See the display specifications on the Elo website www.elotouch.com to find your touchmonitors native resolution. Operating in other resolutions will degrade video performance and is not recommended.

For computer output resolutions at non-native resolutions, the monitor will scale the video to panel's native resolution. For smaller input video resolutions, this involves “stretching” the input image in the X- and Y-dimensions to fit the panel. For larger input video resolutions, this involves “compressing” the input image in the X- and Y-dimensions to fit the panel. An unavoidable byproduct of the scaling algorithms is a loss of fidelity when the computers output video image is scaled by the monitor to fit the display. This loss of fidelity is most apparent when viewing feature-rich images at close distances (for example images containing small-font text).

Your touchmonitor will likely not require video adjustments. However, for analog VGA video, variations in video graphic card outputs may require touchmonitor adjustments through the OSD to optimize the quality of the touchmonitors displayed image. To reduce the need for adjustments for different video mode timings, the monitor correctly scales and displays some of the video industries most common video timing modes.

On-Screen Display (OSD) Connected Through the RJ45 Connection

Five OSD buttons can be found on the OSD remote. There is an LED light which shows the current state of the monitor. The following are the functions that relate to the designated button.

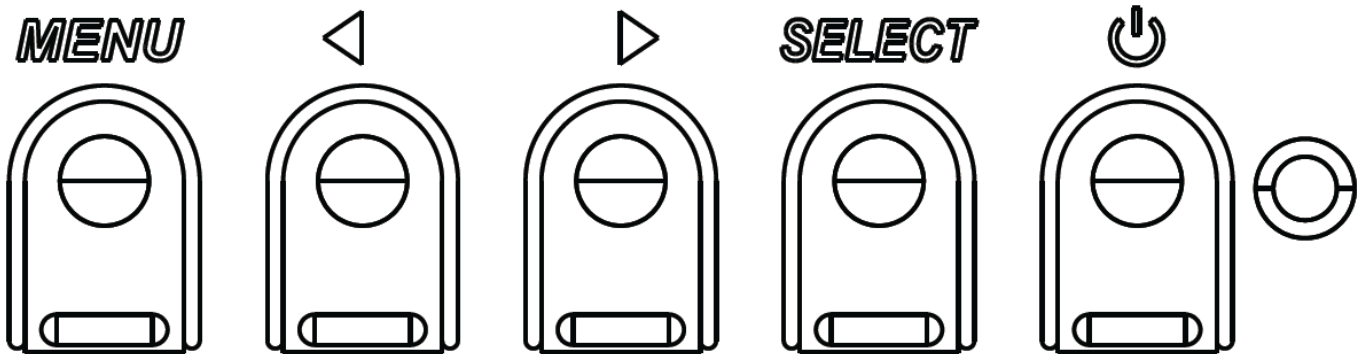

The buttons and their functionality are:

Button	Function when OSD is not displayed:	Function when OSD is displayed:
Menu	Display OSD main menu	Return to previous OSD menu
◀	Display OSD Audio source submenu	Decrease value of selected parameter / select previous menu item
▶	Hot key for changing video source*	Increase value of selected parameter / select next menu item
Select	Display Audio and Video Parameters Menu	Select parameter for adjustment / select submenu to enter
⏻	Power for the monitor	Toggles the power status of the monitor

*The hot key allows the user to quickly change the input video source. If the user accidentally presses this key, they can quickly press the Menu button to cancel a video source change.

Using the OSD buttons controls an on-screen graphical user interface which displays on top of your input video, allowing intuitive adjustment of the following display parameters:

Parameter	Available Adjustment
Main Menu	Video Settings, Audio Settings, Color Settings and Other Settings can be selected
Video Menu	Video Source, Brightness, Contrast, Black Level, Sharpness and Aspect Ratio are available in this menu.
Video Source	Allows the user to switch between the available video sources.
Audio Menu	Allows the user to toggle the mute setting. Also, the volume of the internal speakers or headphones can be adjusted. Default: Not Muted, Volume at 50
Color Menu–	Displays the Color Adjust and Color Preference Menus
HDMI	Allows HDMI video to be displayed on the monitor
VGA Port	Allows VGA video to be displayed on the monitor
DisplayPort	Allows DisplayPort video to be displayed on the monitor
Elo Computer Module	ECM DP – DisplayPort is the standard video output of Elo Computer modules. If HDMI video input is found, the video source can be switched.
Video Source	The monitor continually scans for active video from VGA, DisplayPort, HDMI, and the Computer Module. This adjustment selects which of those input ports should be displayed. If an Elo Computer Module or Intel OPS computer module has been detected, video priority is given to the computer module before any of the external sources.
Brightness	Increase/decrease monitor brightness. Default: 65
Contrast	Increase/decrease monitor contrast. Default: 50
VGA Settings	Allows user to change the H. position, V. position, Clock and Phase. If VGA is selected, the Auto-Adjust feature is available.
Sharpness	Adjusts sharpness of the displayed images. Default: no sharpness adjustment Sharpness function is disabled when the input source ratio is the same as the panels native ratio
Aspect Ratio	Switches the scaling method between Fill Screen and Fill to Aspect Ratio. Default: Fill Screen Fill Screen – Scales the X- and Y-dimensions of the input video (up or down as needed) to the displays native resolution. Fill Aspect Ratio – Assuming a landscape orientation and an input video with aspect ratio smaller than 16:9, scales the Y-dimension of the input video (up or down as needed) to the displays Y-resolution, and scales the X-dimension to maintain the aspect ratio (and fills the rest of the display with equal black bars on the left and right). - When the input source ratio is the same as the panel native ratio, this function is disabled Direct output - Input source is the same with output source and the image will be on the center of the screen. No Scaling will occur. Recalibration may be required when switching between these options.
Light Sensor	The light sensor can be toggled on or off. When the light sensor is enabled, the brightness cannot be changed manually.
Auto Adjust	Automatically adjusts the system clock to the input analog VGA video signal, affecting the H-position, V-position, Clock, and Phase menu items. <i>Not applicable when using HDMI video or the Computer Module.</i>

Clock	Allows fine adjustments of the panels pixel dot clock. <i>Not applicable when using HDMI/DisplayPort video or the Computer Module.</i>
Phase	Allows fine adjustments of the panels pixel dot clock phase. <i>Not applicable when using HDMI/DisplayPort video or the Computer Module.</i>
H-position	Moves the image horizontally on the display in single-pixel increments. Default: centered. <i>Not applicable when using HDMI/DisplayPort video or the Computer Module.</i>
V-position	Moves the image vertically on the display in single-pixel increments. Default: centered. <i>Not applicable when using HDMI/DisplayPort video or the Computer Module.</i>
Black Level	The user can choose between Standard, 5%, 10% or 15% black level offset. The saturation level of the colors change according to the chosen black level offset. Not available when the video source is from VGA.
Color Temperature	Selects the displays color temperature. The available color temperatures are 9300K, 7500K, 6500K, 5500K, and User Defined. If the User Defined option is selected, the user can change the color temperature by changing individual R, G, and B gains on a scale from 0 to 100. Default: User Defined with R, G, and B all set to 100.
Audio Source	Allows the user to choose the audio source. The choices are From Video Source, Line in and ECM Line-in (available only if an ECM is detected) If there is no Computer Module plugged in, and the video source is HDMI, the options are: Line In and HDMI. Default: Line In.
Color Adjust	The Color Temperature menu can be chosen or Hue and Saturation can be varied in this menu. Color Temperature will only be available in the Standard color preference mode. Hue and Saturation are available in the remaining color preferences.
Color Preference	Standard, Movie, Gaming, Photo, Line or Legacy HDMI can be chosen depending on the users preference. Standard Mode: Color and Sharpness are set at an optimal level in this mode. Recommended for use when displaying high quality images and video. This is the default mode. Movie, Gaming and Photo Modes: Allow the user to vary the Hue and Saturation depending on application. Line Mode: Recommended for use when displaying text or lines. Legacy HDMI Mode: Black levels are lighter in comparison to Standard Mode. Only applies if HDMI is the video source.

Other Menu	<p>OSD menu: The Horizontal position, vertical position and OSD timer can be changed from here.</p> <p>Language Settings can be changed</p> <p>Recall Defaults: set the system back to the preset standards</p> <p>Information: display information about the monitor and system</p> <p>MDC Protocol: allows the user to choose between DDC/CI and RS232 mode for the MDC utility</p> <p>Support & Help: Provide information about help and support</p> <p>System Temperature: Provides the system Temperature information. If the Elo computer module is inserted, there will be a secondary line showing that temperature information.</p>
OSD Timer	<p>Adjusts how long a period of OSD button inactivity the Touchmonitor will wait before closing the OSD. The adjustable range is between 5 and 60 seconds.</p> <p>Default: 15 seconds</p>
OSD Language	<p>Selects which language the OSD information is displayed in. The available languages are: English, French, Italian, German, Spanish, Simplified Chinese, Traditional Chinese, and Japanese.</p> <p>Default: English.</p>
OSD H-Position	<p>Moves the OSD location left and right on the display.</p> <p>Default: 50 (centered)</p>
OSD V-position	<p>Moves the OSD location up and down on the display.</p> <p>Default: 50 (centered)</p>
Recalling Defaults	<p>Selecting "Recall Defaults" restores all factory default settings for OSD-adjustable parameters (except OSD Language and OSD Position) and for Preset Video Mode timings.</p>
Power Behavior	<p>When power to the monitor is lost and regained, the behavior that is chosen will be executed.</p> <p>Always On</p> <p>Always Off</p> <p>Last State</p>
MDC Protocol	<p>This menu allows the user to switch between the serial protocol and the DDC/CI protocol.</p> <p>DDC/CI protocol is used to communicate to a host computer via the video signal.</p>
Tabletop	<p>Enables or disables the Tabletop Thermal Protection Mode settings</p>
Information	<p>Displays Monitor Information, System Temperature and Help & Support options.</p> <p>Nothing is adjustable in this menu.</p>
Monitor Information	<p>Displays the touchmonitor model and the monitor and touchscreen serial # information</p>
System Temperature	<p>Displays the real-time temperature of the Video Board</p> <p><i>Note: Docking Board and the CPU Sensor temperatures are only available if these features are supported by the computer module.</i></p>
Help & Support	<p>Display information regarding Elo Touch Solutions contact information.</p>

All touchmonitor adjustments made through the OSD are automatically memorized as soon as they are entered. This feature saves you from having to reset your choices every time the touchmonitor is unplugged or powered off and on or if there is a power failure.

OSD and Power Lockouts

Press and hold the “Menu” and “>” buttons for one seconds to enable/disable the OSD Locking feature. When the OSD Locking is enabled, pressing any of the Menu, Up, Down, or Select keys will have no effect on the system.

Press and hold the “Menu” and “<” buttons for one seconds to enable/disable the Power Locking feature. When the Power Locking is enabled, pressing the power switch will have no effect on the system.

Audio

Audio from the touchmonitor Line In, touchmonitor HDMI, touchmonitor DisplayPort, computer module Line In, or computer module HDMI or DisplayPort ports can be played over the touchmonitors internal speakers. See the “Audio Source” OSD parameter for details. When headphones are plugged into the headphone output jack, the internal speakers turn off and audio is played over the headphones.

Volume and muting of the speaker and headphone outputs can be controlled by the OSD.

MDC Functionality (For Remote Monitor Applications)

The touchmonitor has the ability to allow remote access from a host application. This is done through the use of the Multiple Display Control command sets. By installing the IDS Utilities Suite, the user can communicate with the monitor via the application. The host application can send a variety of different instructions which will be executed on the IDS 01 series touchmonitor. For detailed information, refer to the utilities suite user guide.

RFID Functionality

For 3201L and 4201L Units:

There is an integrated RFID antenna within the monitor. To enable the RFID functionality, a RFID reader module (available at www.elotouch.com) must be installed and connected to the integrated monitor antenna. Refer to the RFID peripheral installation guide for proper hardware and software installation techniques.

For the 5501L and 7001L units, an external peripheral kit is available from Elo.

The list of RFID protocols that can be read are:

- ISO-14443-A
- ISO-14443-B
- ISO-15693

The RFID features Peer-to-Peer applications and the Read and Write functionality.

The location of the RFID antenna is indicated by the arrow in the following location. RFID tags can be read at a distance of up to 40 mm away from the bezel.



For best results, touch the tag directly to the bezel area containing the antenna.

Driver Installation

Elo Computer Modules (ECMG2-i3 or i5), have all required drivers preinstalled.

All required drivers are available online at www.elotouch.com. If drivers are to be installed from the included CD, an external CD-Rom drive is required.

For No Operating System (OS) units, the drivers are provided on the accompanying driver CD and are available online at www.elotouch.com.

For Windows Operating Systems

After the computer finishes booting up, follow these instructions to install the drivers:

- Attach the external CD-Rom drive to the monitor and turn the computer on
- Insert the drivers CD
- After the OS has booted, right click on "My Computer"
- Click on Manage
- Click on Device Manager
- Highlight one of the devices that has a warning label and click "Update Driver"
- Click the option "Browse My Computer for Driver Software"
- Choose the path to your CD-Rom drive and click "Next"
- Let the device software component be installed and then proceed to the next device.
- Do this for all of the devices that have the warning label.

For Mac OS X higher, these drivers are automatically installed when the system is connected to the monitor. To find information on the drivers, do the following:

NOTE: The Elo Touch Solutions Touchmonitor ID will be different per touch technology.

In Mac OS X:

- Open the Terminal window and under Hardware select USB. A screen that looks like the image below will appear. The available USB devices will be displayed.

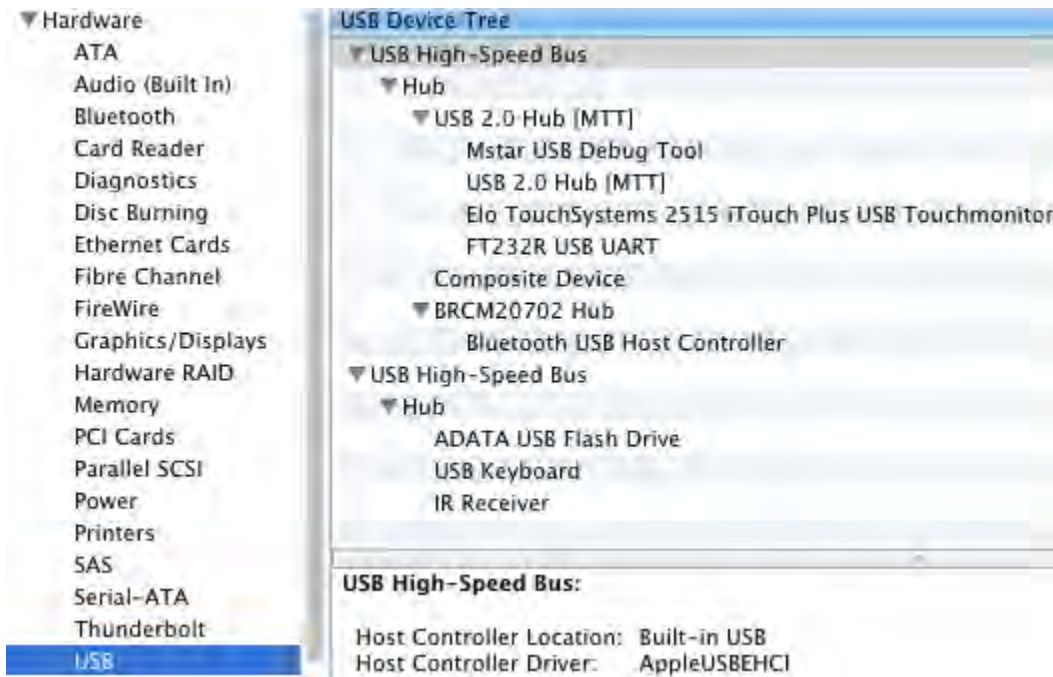

In Ubuntu versions that support touch:

- Open a Terminal window and type "lsusb" as the command. A screen that looks like below will open. The available USB devices will be displayed.

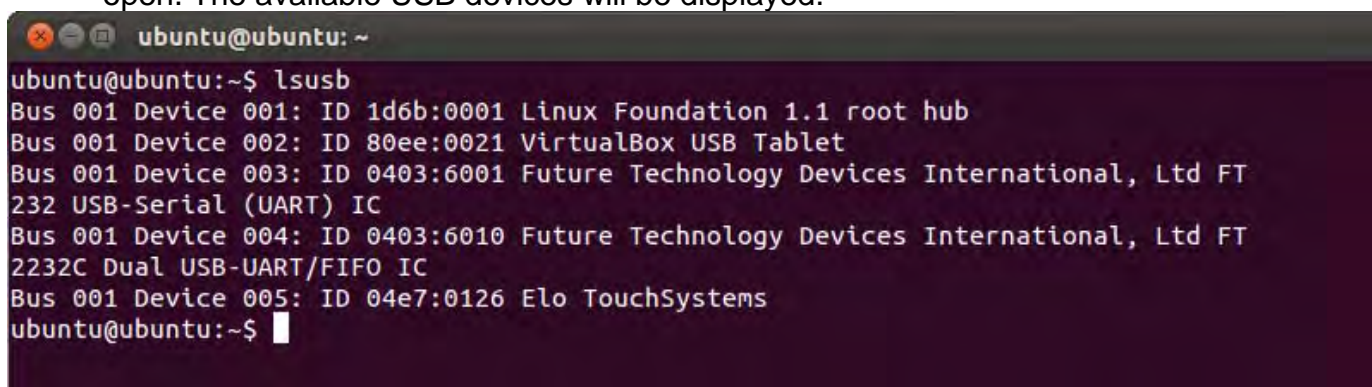

Temperature Control

The IDS 01 Series monitors contain a temperature sensor that provides the user with real-time temperature readings. This reading can be found on the OSD menu by clicking on: Other Menu ► Information ► System Temperature. If the monitor senses temperatures higher than the operating range, the monitor will go into “Thermal Protection Mode.” This mode allows the monitor to remain operational during brief periods of use outside of its operating range.



Example of OSD showing the Video Board Temperature

In Thermal Protection Mode, the monitor will reduce the backlight brightness to bring the internal temperature back within operating range. While in this mode, brightness cannot be increased. If the internal temperature decreases below the Thermal Protection Mode temperature for at least five minutes, normal operation is resumed. The OSD temperature at which the monitor will enter the Thermal Protection Mode is in the table below.

When the Thermal Protection Mode is enabled, the following icon will appear in the Main Menu and the Brightness Menu. This will indicate that the Thermal Protection Mode is active.

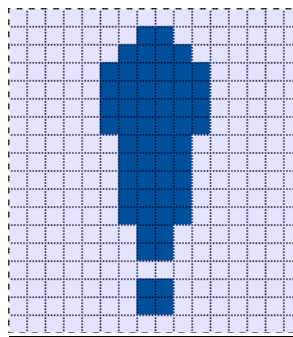

Icon showing that Thermal Protection Mode is active

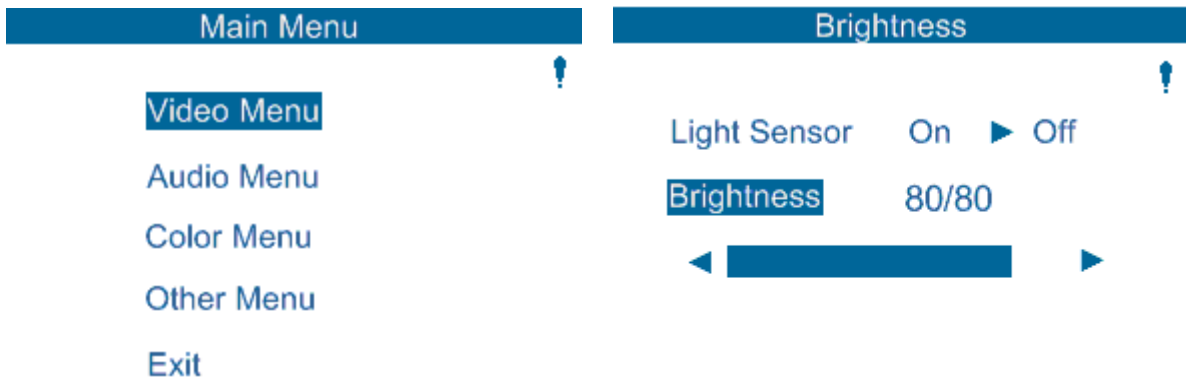

Thermal Protection Mode icon will show on the top corner of these menus indicating that the Thermal Protect Mode is active

The user will be prompted to shut off the monitor within sixty seconds if the temperature continues to rise after Thermal Protection Mode Step 2 has been enabled. If the system is not manually turned off in sixty seconds, the touchmonitor will automatically turn off to prevent permanent damage to the monitor. The table below shows the Auto Shut Off temperature.

Note: This will only enable in extreme conditions.

Portrait and Landscape Mode

Monitor Size	Thermal Protection Mode (°C) Step 1	Thermal Protection Mode (°C) Step 2	Auto Shut Off Temperature (°C)
ET32/4201L	60	65	70
ET5501L	56	61	65
ET7001L	50	55	63

In the event that Thermal Protection Mode Step 1 or 2 has been enabled, the monitor will resume full operational capabilities after the OSD temperature decreases to the values set forth in the table below. These temperatures must be retained for at least five minutes.

Monitor Size	Thermal Protection Mode Step 1 Disabled (°C)
ET32/4201L	55
ET5501L	53
ET7001L	45

If Thermal Protection Mode Step 2 is reached, the internal temperature needs to first decrease back to the Step 1 temperature and then decrease further to the value required to disable Thermal Protection Mode 1.

Example of Thermal Protection Mode for an ET4201L Monitor with 100% Brightness:

At Step 1: OSD = 60, Brightness = 80%

Normal operation returns if OSD can maintain 55°C or lower temperature for five minutes.

At Step 2: OSD = 65, Brightness = 72%

Return to Step 1 if OSD can maintain 60°C or lower temperature for five minutes.

If the monitors internal temperature continues to rise, the monitor will shut off at OSD = 70°C

Table Top Mode

Requirements:

1. The Table Top Mode function on the OSD must be enabled if the unit is placed in table top orientation.
2. Cooling methods must be put in place to ensure that the air temperature beneath the monitor does not exceed the operating specifications. Consult chapter 7 for operating temperature specifications.

Note: The warranty will be void if failure occurs to the monitor in table top mode orientation and the Table Top Mode function is not enabled without adequate cooling methods installed.

When the monitor is in Table top mode, the Thermal Protection steps are different. These OSD values are stated in the table below.

Monitor Size	Thermal Protection Mode Enabled (°C) Step 1	Thermal Protection Mode Enabled (°C) Step 2	Thermal Protection Mode Enabled (°C) Step 3	Auto Shut Off Temperature (°C)
ET32/4201L	60	65	70	75
ET5501L	57	61	n/a	65
ET7001L	59	64	69	74

Intelligent Brightness Control

The IDS 01 touchmonitors include a light sensor that adjusts the brightness of the screen in accordance with the ambient light level surrounding the monitor. The Intelligent Brightness Control functions based on the following curve:

ET3201L:

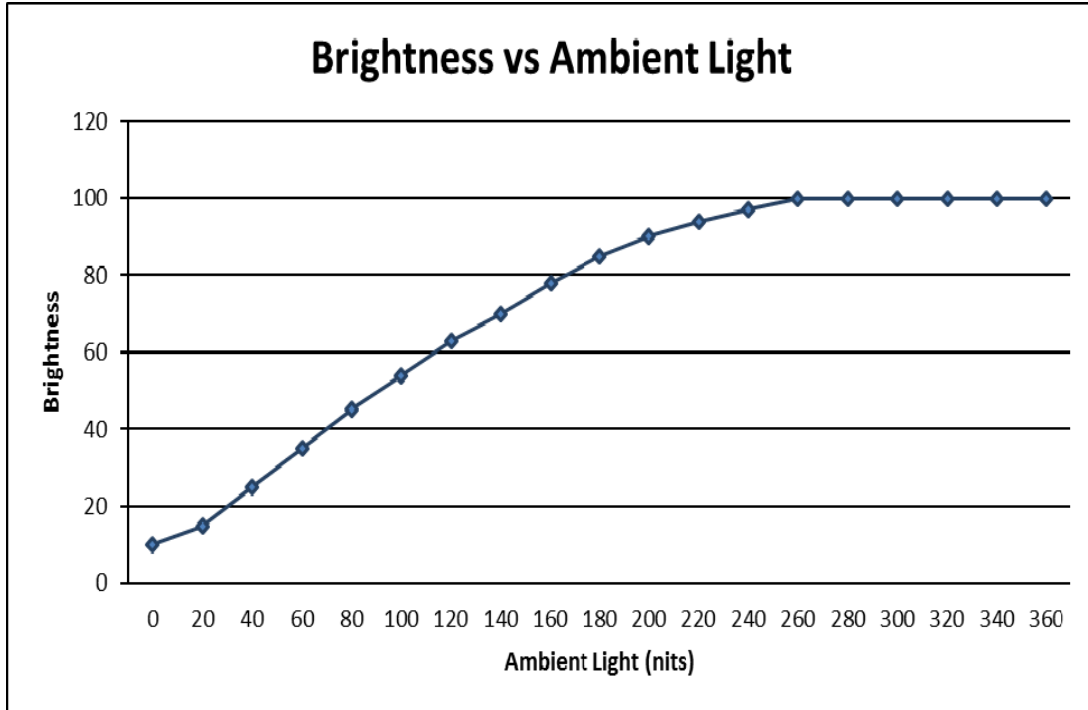

ET4201L

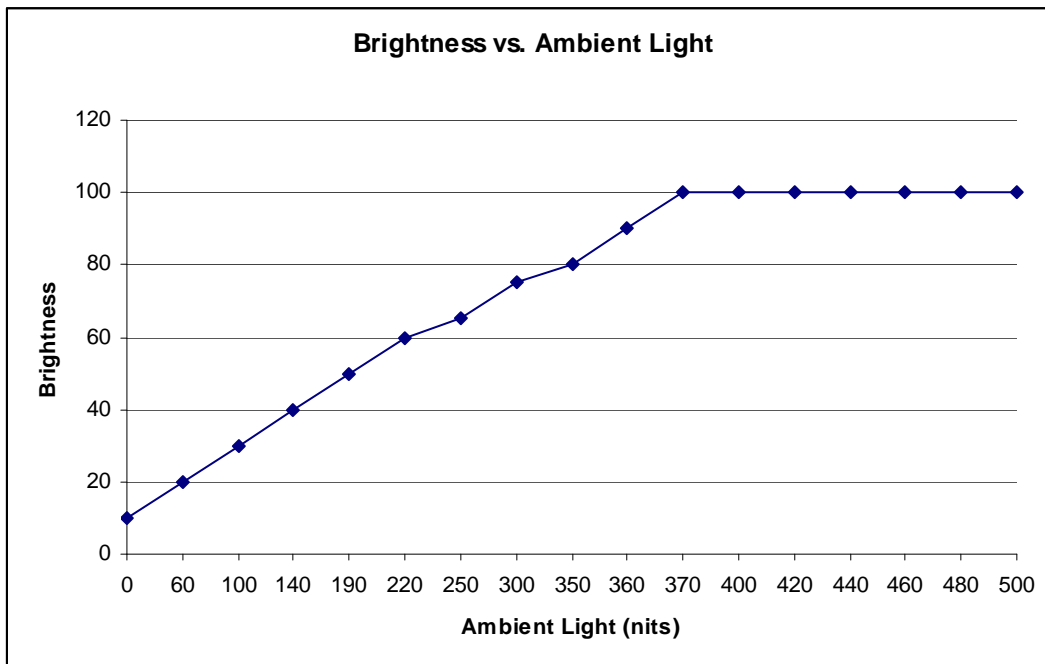

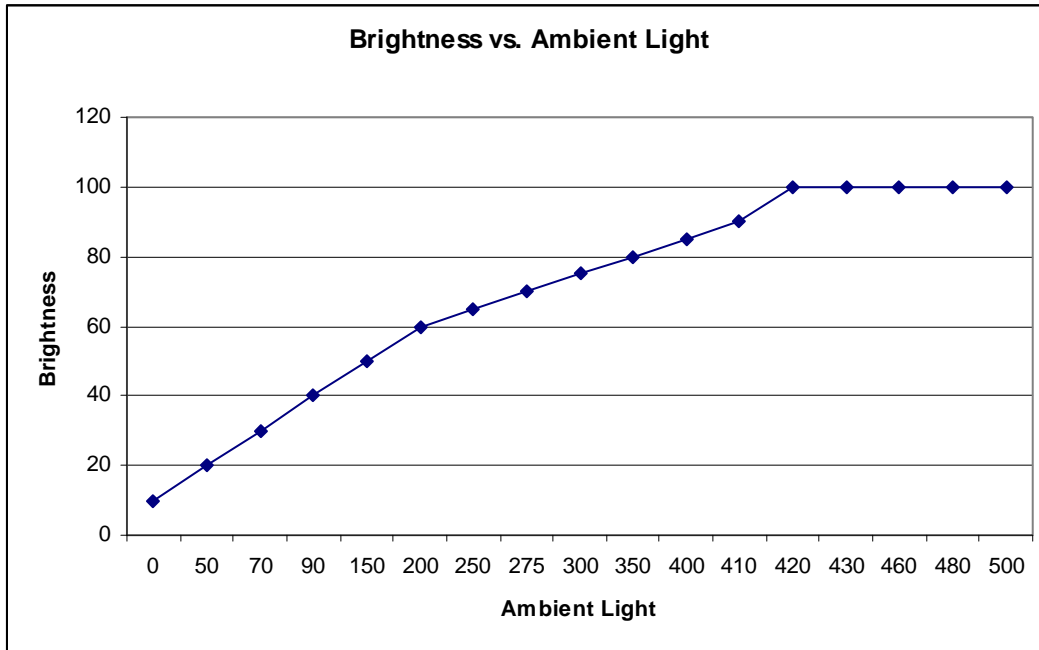

Note: If the Thermal Protection Mode is activated, the Intelligent Brightness Control feature will act within the limits set forth in the Temperature Control section.

Video Firmware Upgrade

The IDS 01 series touchmonitors contain the ability to update the video firmware with the use of an external computer. Contact Elo customer service for information on how to upgrade the video firmware.

Chapter 6: Technical Support

If you are experiencing trouble with your touchmonitor, refer to the following suggestions. If the problem persists, please contact your local dealer or contact Elo Touch Solutions Customer Service.

Solutions to Common Problems

Problem	Suggested Troubleshooting
The Touchmonitor does not respond when turning on the system.	Check that the AC power cable is properly connected. Verify the AC power source is functioning.
The Computer Module does not respond when turning on the system.	Disconnect the AC power cable and verify that the Computer Module is properly installed. Reconnect the AC power cable.
Monitor display is dim.	Use the OSD to increase the brightness. Use the OSD to increase the contrast.
Monitor display is blank.	If the Power Status LED is blinking, the monitor or Computer Module may be in SLEEP mode. Press any key / move the mouse / touch the touchscreen to see if the image reappears.
Monitor displays an "Out Of Range" message.	Adjust your computers resolution/timing mode such that it is within the allowable timing ranges specified for your Touchmonitor on the Elo website www.elotouch.com .
Touch functionality doesn't work.	Verify your computer or Elo Computer Module has the latest drivers installed. For optical units, remove and Elo driver and restart the computer. Refer to the Setup chapters for details.

To keep the product operating at an optimum level please limit the product usage cycle to 18 hours for every 24 hours:

Usage duty cycle:
18 hours on per 24 hours

Elo recommends using the Content Management System or O/S scheduling settings and/or EloView commands to manage duty cycle. This will enable power savings and trouble free operation throughout the life of the monitor.

Technical Assistance

Visit www.elotouch.com/go/websupport for online self-help.
Visit www.elotouch.com/go/contactsupport for technical support.
See this user manuals last page for worldwide technical support phone numbers.

Chapter 7: Safety & Maintenance

Safety

To avoid risk of electric shock, follow all safety notices and do not disassemble the touchmonitor or Computer Module. They are not user-serviceable.

Do not block or insert anything inside any of the ventilation slots.

The touchmonitor is equipped with a 3-wire, grounding power cord. The power cord plug only fits into a grounded outlet. Do not fit or modify the plug into an outlet that has not been configured for this purpose. Do not use a damaged power cord. Only use the power cord that came with your Elo Touchmonitor. Use of an unauthorized power cord may invalidate your warranty.

Ensure that the system is maintained and runs within the specified environmental conditions listed in the products specifications available on the Elo Touch Solutions website www.elotouch.com.

Environmental conditions for transportation and storage

Temperature:

Portrait and Landscape Mode:

Operating	0°C to 40°C
Storage/Transportation	-20°C to 50°C

Table Top Mode

Operating Temperature (Independent of altitude):	0°C to 35°C
Non-Operating Temperature (Independent of altitude):	-20°C to 50°C

Humidity (non-condensing) :

Operating	20% to 80%
Storage/Transportation	10% to 95%

Altitude:

Operating	0 to 3,658m
Storage/Transportation	0 to 12,192m

Care and Handling

The following tips will help maintain optimal performance of your touchmonitor:

- Disconnect the AC power cable before cleaning.
- To clean the display, use a cloth lightly dampened with a mild detergent.
- It is important that your unit remains dry. Do not get liquids on or inside the unit. In the event that liquid does get inside, have a qualified service technician inspect the unit before you power it on again.
- Do not wipe the screen with a cloth or sponge that could scratch the surface.
- When cleaning the touchscreen, use window or glass cleaner applied to a clean cloth or sponge. Never apply the cleaner directly on the touchscreen. Do not use alcohol (methyl, ethyl or isopropyl), thinner, benzene, or other abrasive cleaners.



Waste Electrical & Electronic Equipment Directive (WEEE)



This product should not be disposed of with household waste. It should be deposited at a facility that enables recovery and recycling.

Elo has put in place recycling arrangements in certain parts of the world. For information on how you can access these arrangements, please visit <http://www.elotouch.com/AboutElo/ewaste-program/>.

Chapter 8: Regulatory Information

I. Electrical Safety Information:

Compliance is required with respect to the voltage, frequency, and current requirements indicated on the manufacturer's label. Connection to a different power source than those specified herein will likely result in improper operation, damage to the equipment or pose a fire hazard if the limitations are not followed.

There are no operator serviceable parts inside this equipment. There are hazardous voltages generated by this equipment which constitute a safety hazard. Service should be provided only by a qualified service technician.

Contact a qualified electrician or the manufacturer if there are questions about the installation prior to connecting the equipment to mains power.

II. Emissions and Immunity Information

Notice to Users in the United States: This equipment has been tested and found to comply with the limits for a Class A digital device, pursuant to Part 15 of FCC Rules. These limits are designed to provide reasonable protection against harmful interference in a residential installation. This equipment generates, uses, and can radiate radio frequency energy, and if not installed and used in accordance with the instructions, may cause harmful interference to radio communications.

Notice to Users in Canada: This equipment complies with the Class A limits for radio noise emissions from digital apparatus as established by the Radio Interference Regulations of Industrial Canada.

Notice to Users in the European Union: Use only the provided power cords and interconnecting cabling provided with the equipment. Substitution of provided cords and cabling may compromise electrical safety or CE Mark Certification for emissions or immunity as required by the following standards:

This Information Technology Equipment (ITE) is required to have a CE Mark on the Manufacturer's label which means that the equipment has been tested to the following Directives and Standards: This equipment has been tested to the requirements for the CE Mark

as required by EMC Directive 2004/108/EC as indicated in European Standard EN 55022 Class A and the Low Voltage Directive 2006/95/EC as indicated in European Standard EN 60950-1.

General Information to all Users: This equipment generates, uses and can radiate radio frequency energy. If not installed and used according to this manual the equipment may cause interference with radio and television communications. There is, however, no guarantee that interference will not occur in any particular installation due to site-specific factors.

This device complies with part 15 of the FCC Rules. Operation is subject to the following two conditions: (1) This device may not cause harmful interference, and (2) this device must accept any interference received, including interference that may cause undesired operation.

- 1) In order to meet emission and immunity requirements, the user must observe the following:
 - a) Use only the provided I/O cables to connect this digital device with any computer.
 - b) To ensure compliance, use only the provided manufacturer's approved line cord.
 - c) The user is cautioned that changes or modifications to the equipment not expressly approved by the party responsible for compliance could void the user's authority to operate the equipment.
- 2) If this equipment appears to cause interference with radio or television reception, or any other device:
 - a) Verify as an emission source by turning the equipment off and on.

If you determine that this equipment is causing the interference, try to correct the interference by using one or more of the following measures:

- i. Move the digital device away from the affected receiver.
- ii. Reposition (turn) the digital device with respect to the affected receiver.
- iii. Reorient the affected receiver's antenna.
- iv. Plug the digital device into a different AC outlet so the digital device and the receiver are on different branch circuits.
- v. Disconnect and remove any I/O cables that the digital device does not use. (Unterminated I/O cables are a potential source of high RF emission levels.)
- vi. Plug the digital device into only a grounded outlet receptacle. Do not use AC adapter plugs. (Removing or cutting the line cord ground may increase RF

emission levels and may also present a lethal shock hazard to the user.)

If you need additional help, consult your dealer, manufacturer, or an experienced radio or television technician.

III. Agency Certifications

The following certifications and marks have been issued or declared for this monitor:

Argentina S-Mark
 Australia RCM
 Canada CUL, IC
 China CCC
 Europe CE

Japan VCCI
 Korea KC
 Mexico CoC
 Russia EAC

Taiwan BSMI
 United States FCC, UL

IV. China RoHS

In accordance to Chinese law (Administration on the Control of Pollution Caused by Electronic Information Products), the section below lists out the name and amount of the toxic and/or hazardous materials that this product may contain.

Component Name	Toxic or Hazardous Substances and Elements					
	Lead(Pb)	Mercury(Hg)	Cadmium(Cd)	Hexavalent Chromium (Cr6+)	Polybrominated Biphenyls (PBB)	Polybrominated Diphenyl Ethers (PBDE)
Plastic Parts	O	O	O	O	O	O
Metal Parts	X	O	O	O	O	O
Wire and Cable Assembly	X	O	O	O	O	O
LCD Panel	X	O	O	O	O	O
Touch Screen Panel	X	O	O	O	O	O
PCBA	X	O	O	O	O	O
Software (CD, etc.)	O	O	O	O	O	O

O: Indicates that this toxic or hazardous substance contained in all of the homogeneous materials for this component is below the limit requirement in SJ/T11363-2006.
 X: Indicates that this toxic or hazardous substance contained in at least one of the homogeneous materials used for this component is above the limit requirement in SJ/T11363-2006. For items marked with X, exemptions were taken according to EU RoHS.

Explanation of Markings

(1). In accordance with the SJ/T11364-2006 requirement, the electronic information products are marked with the following pollution control logo. The Environment-Friendly Use Period for this product is 10 years. The product will not leak or mutate under normal operating conditions listed below, so that the use of this electronic information product will not result in any severe environmental pollution, any bodily injury, or damage to any assets.

Operating Temperature: 0-40 / Humidity: 20%-80% (non-condensing).

Storage Temperature:-20~60 / Humidity: 10%~90% (non-condensing).



(2). It is encouraged and recommended that this product be recycled and reused according to local laws. The product should not be thrown away casually.



Chapter 9: Warranty Information

For warranty information, go to <http://www.elotouch.com/Support/warranty.asp>

Check out our website

www.elotouch.com

Get the latest...

- Product Information
- Specifications
- Upcoming events
- Press releases
- Software drivers

Getting in Touch with Us

To find out more about the extensive range of Elo touch solutions, visit our website at www.elotouch.com, or simply call the office nearest you:

North America		Europe	Asia-Pacific	Latin America
Elo Touch Solutions	Tel 800-ELO-TOUCH Tel + 1 408 597 8000	Tel +32 (0) 16 70 45 00	Tel +86 (21) 3329 1385	Tel 786-923-0251
1033 McCarthy Blvd	Fax +1 408 597 8001	Fax +32 (0)16 70 45 49	Fax +86 (21) 3329 1400	Fax 305-931-0124
Milpitas, CA 95035	customerservice@elotouch.com	elosales@elotouch.com	www.elotouch.cn	www.elotouch.com.ar

Copyright 2014 Elo Touch Solutions, Inc. All rights reserved