



## Scanner Canon DR-C225 II

Com design inovador e compacto, o Scanner de Documentos Canon imageFORMULA DR-C225 II libera espaço na mesa, balcão ou prateleira.

- Chapter 1 Introduction
- Chapter 2 Important Safety Instructions
- Chapter 3 Installing the Software
- Chapter 4 Connecting the Scanner
- Chapter 5 Placing Documents
- Chapter 6 Scanning with CaptureOnTouch
- Chapter 7 Setting the Scanner Driver
- Chapter 8 Special Scanning
- Chapter 9 Regular Maintenance
- Chapter 10 Replacing Consumable Parts
- Chapter 11 Uninstalling the Software
- Chapter 12 Troubleshooting
- Chapter 13 Appendix



**imageFORMULA**  
**DR-C225 II**  
**DR-C225W II**

## **User Manual**

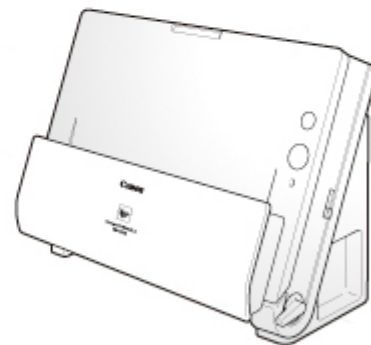

**Please read this manual before operating this scanner.  
After you finish reading this manual, store it in a safe  
place for future reference.**

# Chapter 1 Introduction

Thank you for purchasing the Canon imageFORMULA DR-C225 II/C225W II Document Scanner.

In order to fully understand the features of this scanner and use them more effectively, please read this manual and the manuals shown below thoroughly before using the product. After reading, store the manual in a safe place for future reference.

<b>About This Manual</b> .....	<b>2</b>
<b>Features of the Scanner</b> .....	<b>3</b>
<b>Names and Functions of Parts</b> .....	<b>5</b>
<b>Regulations</b> .....	<b>7</b>
<b>Trademarks</b> .....	<b>9</b>

## About This Manual

### Manuals for the Scanner

Documentation for this scanner consists of the following manuals.

- Setup Guide  
This provides complete and comprehensive information about the scanner.
- User Manual (this manual)  
This manual contains complete explanations for operations on the scanner. This manual is stored on the supplied Setup Disc as an electric manual.



The User Manual will be registered to the following location in the start menu after you install the software on the Setup Disc.

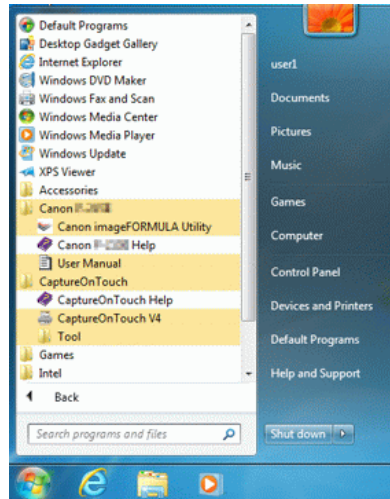

Register Windows 8.1 at the following locations.

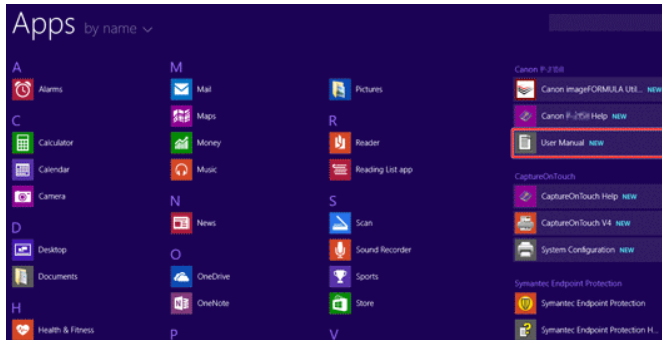

## Mac

After the software is installed from the setup disc, the User Manual is shown below.

/Applications/DR-C225 User Manual.app

### Symbols Used in This Manual

The following symbols are used in this manual to explain procedures, restrictions, handling precautions, and instructions that should be observed for safety.



### WARNING

Indicates a warning concerning operations that may lead to death or injury to persons if not performed correctly. To use the machine safely, always pay attention to these warnings.



### CAUTION

Indicates a caution concerning operations that may lead to injury to persons, or damage to property if not performed correctly. To use the machine safely, always pay attention to these cautions.



### IMPORTANT

Indicates operational requirements and restrictions. Be sure to read these items carefully to operate the machine correctly, and avoid damage to the machine.



### NOTE

Indicates a clarification of an operation, or contains additional explanations for a procedure. Reading these notes is highly recommended.

## Features of the Scanner

The main features of the DR-C225 II/C225W II document scanner are described below.

- Compact Design  
The scanner has a compact size of 300 (W) x 339 (H) x 235 (D) (11.81" (W) x 13.3" (H) x 9.25" (D)) mm when the document feed is open. A newly designed feed mechanism saves space by eliminating the need for space to eject paper at the front of the scanner.
- Fast Document Feeding  
Documents can be scanned at a speed of up to 25 pages per minute (when scanning one-sided or two-sided documents of A4 size at 200 dpi).
- Two Eject Paths for Scanning a Variety of Documents  
Use the U-turn path to scan paper of standard thickness, or use the straight path to scan cards and other thick documents.
- High Image Quality  
The 600 dpi optical resolution sensor incorporated in the scanner enables documents to be scanned with high image quality.
- USB 2.0 Interface  
The scanner supports Hi-Speed USB 2.0.
- Color/Grayscale Support  
Documents can be scanned in 24-bit color or 256-level grayscale.

- Supports a Variety of Scanning Modes

The scanner supports the following scanning modes, depending on the document type:

- Single-sided or double-sided scanning (with Skip Blank Page function)
- Continuous or single sheet feed

- Card Scan

You can scan business or ID cards.

- Paper Size Detection

The scanner automatically detects the size of a scanned document and eliminates any unnecessary space around the edges of the image when storing the image, even when storing a document of irregular size.

- Auto Color Detection

The scanner detects whether the scanned document is in color, grayscale, or black and white (binary), and saves the image accordingly.

- Full Auto Mode

A Full Auto Mode is provided in CaptureOnTouch and the scanner driver to allow scanning under automatically determined conditions. Scanning conditions such as the color mode and page size are set automatically based on the document being scanned.

- Auto Resolution Detection

When enabled in the CaptureOnTouch or scanner driver settings, this function detects the content of documents and determines the scanning resolution automatically.

- Folio Scan

You can scan folded documents. The scanner will scan both sides and combine the scanned images into a single image.

- Deskew

The scanner straightens scanned images when it detects that the document was placed askew.

- Ultrasonic Double Feed Detection

Ultrasonic waves are used to detect pages that are fed at the same time as well as the space between pages. Scanning stops if a double feed is detected.

- Text Enhancement Modes

The scanner is equipped with the Advanced Text Enhancement Mode (only for Windows), for enhancing the text of documents with dark or uneven backgrounds, and the Advanced Text Enhancement II mode, for enhancing the text when both the text and background are light.

These modes may not work, depending on the type of document.

- Color Drop-out

The scanner is equipped with a Color Drop-out function that enables you to specify a color for the scanner to omit from the scanned image during black and white or grayscale scanning.

- Skip Blank Page Function

The scanner is equipped with a Skip Blank Page function that enables you to scan a document without storing images of blank pages, regardless of whether each page of the document is two-sided or one-sided. Both sides are scanned, but saving the image is skipped for scan images judged to be from a blank page.

- Prescan Function

The scanner is equipped with a Prescan function that allows you to adjust the contrast and brightness of a prescanned image and then send the adjusted image to the application software, without needing to scan the document again.

- Character/Line Emphasis Function

If characters and lines in scanned images are not clearly visible, you can use this function to adjust their thickness during scanning.

- CaptureOnTouch

The bundled CaptureOnTouch software lets you register specific scanning procedures suited to particular document types and applications for easy access just by selecting the scanning job.

- Scanning Shortcut

Using CaptureOnTouch, you can register commonly used combinations of scan modes and output methods as [Scanning Shortcut] for quick access. Any [Scanning Shortcut] can be assigned a start button.

- Auto Start

The scanner is equipped with an auto start function, which enables scanning to be automatically started when a document placed in the feeder is detected.

- Sleep Mode

The scanner is designed to save energy by entering the sleep mode when it is not scanning documents.

- Wi-Fi connectivity (DR-C225W II only)

You can operate the scanner and load document from a PC or other device with a wireless connection.

The Wi-Fi function supports scanning operations and document loading via wireless connection to a PC or other device.



## NOTE

In the software, this scanner is indicated as "DR-C225".

## Names and Functions of Parts

This section describes the name and function of each part. Make sure to read this section and familiarize yourself with the parts of the scanner before using the scanner.

### ■Front View

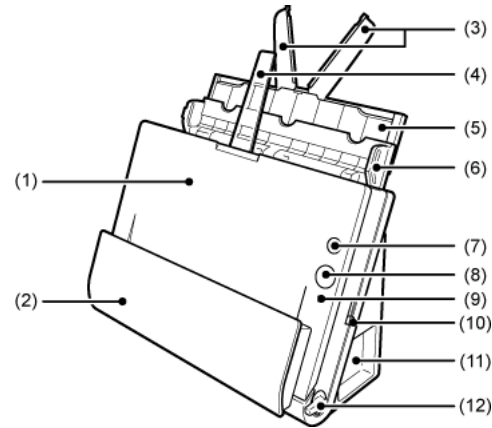

- (1) Front Unit  
Open this when removing paper jammed inside the scanner, cleaning the inside of the scanner, or replacing rollers.
- (2) Document Eject Pocket  
Scanned documents are output here.
- (3) Feed Extension Plates  
Pull this out when loading long documents.
- (4) Eject Support  
Open this when loading long documents.
- (5) Feed Support  
Pull out this to support loaded documents.
- (6) Document Feed Tray  
Open this when loading documents for scanning.
- (7) Power Button  
This turns the scanner ON and OFF.

- (8) Start Button  
This starts scanning the document loaded in the document feed tray
- (9) Feed Selection Indicator  
This indicates the way documents are currently being fed in accordance with the position of the feed selection lever.

Lever position	Indicator color
Upper (non separation feeding)	White
Lower (standard feeding)	Black

- (10) Feed Selection Lever  
This changes the way documents are fed.
- (11) Connectors  
Connectors for connecting an AC adapter and USB cable are available.
- (12) Eject Selection Lever  
Use this lever to change the way documents are ejected.

## ■Connectors

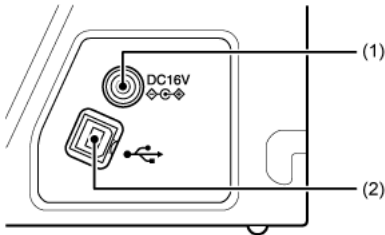

- (1) Power Connector  
Connect the supplied AC adapter to this connector.
- (2) USB Connector  
Connect the supplied USB cable to this connector.

## ■Back View

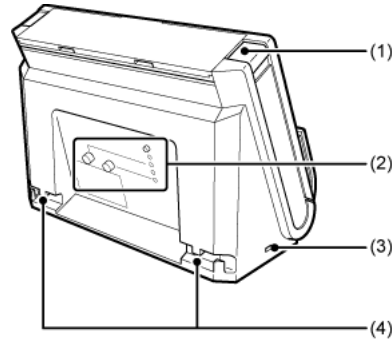

- (1) OPEN Button  
Press this button to open the front unit.
- (2) Wi-Fi function setting location (DR-C225W II only)  
Set and confirm wireless connection using the Wi-Fi function.
- (3) Kensington Slot  
Connect an anti-theft key chain or the like.
- (4) Cable Grooves  
Secure the USB cable and power cord that are connected to the scanner along the rear of the scanner. Use these when you want to run the cables on the side opposite the connectors.

# Regulations

---

---

## FCC/IC REGULATIONS (For North America)

Document Scanner, Model 6130050/6130060

This device complies with Part 15 of FCC Rules and Industry Canada licence-exempt RSS standard(s). Operation is subject to the following two conditions: (1) this device may not cause interference, and (2) this device must accept any interference, including interference that may cause undesired operation of this device.

Le présent appareil est conforme aux la partie 15 des règles de la FCC et CNR d'Industrie Canada applicables aux appareils radio exempts de licence. L'exploitation est autorisée aux deux conditions suivantes : (1) l'appareil ne doit pas produire de brouillage, et (2) l'utilisateur de l'appareil doit accepter tout brouillage radioélectrique subi, même si le brouillage est susceptible d'en compromettre le fonctionnement.

This equipment complies with FCC/IC radiation exposure limits set forth for an uncontrolled environment and meets the FCC radio frequency (RF) Exposure Guidelines in Supplement C to OET65 and RSS-102 of the IC radio frequency (RF) Exposure rules. This equipment has very low levels of RF energy that it deemed to comply without maximum permissive exposure evaluation (MPE). But it is desirable that it should be installed and operated keeping the radiator at least 20cm or more away from person's body (excluding extremities: hands, wrists, feet and ankles).

Cet équipement est conforme aux limites d'exposition aux rayonnements énoncées pour un environnement non contrôlé et respecte les règles des radioélectriques (RF) de la FCC lignes directrices d'exposition dans le Supplément C à OET65 et d'exposition aux fréquences radioélectriques (RF) CNR-102 de l'IC. Cet équipement émet une énergie RF très faible qui est considérée conforme sans évaluation de l'exposition maximale autorisée. Cependant, cet équipement doit être installé et utilisé en gardant une distance de 20 cm ou plus entre le dispositif rayonnant et le corps (à l'exception des extrémités : mains, poignets, pieds et chevilles).

## FCC CAUTION

Changes or modifications not expressly approved by the party responsible for compliance could void the user's authority to operate the equipment.

**Note:** This equipment has been tested and found to comply with the limits for a Class B digital device, pursuant to Part 15 of the FCC Rules. These limits are designed to provide reasonable protection against harmful interference in a residential installation. This equipment generates, uses,

and can radiate radio frequency energy and, if not installed and used in accordance with the instructions, may cause harmful interference to radio communications. However, there is no guarantee that interference will not occur in a particular installation. If this equipment does cause harmful interference to radio or television reception, which can be determined by turning the equipment OFF and ON, the user is encouraged to try to correct the interference by one or more of the following measures:

- Reorient or relocate the receiving antenna.
- Increase the separation between the equipment and receiver.
- Connect the equipment into an outlet on a circuit different from that to which the receiver is connected.
- Consult the dealer or an experienced radio/TV technician for help.

Use of shielded cable is required to comply with Class B limits in Subpart B of Part 15 of FCC Rules.

Do not make any changes or modifications to the equipment unless otherwise specified in the manual. If such changes or modifications should be made, you could be required to stop operation of the equipment.

Canon U.S.A. Inc.

One Canon Park, Melville, NY 11747, U.S.A.

Tel. No. 1-800-OK-CANON (1-800-652-2666)

This transmitter must not be co-located or operated in conjunction with any other antenna or transmitter.

## RADIO INTERFERENCE REGULATIONS (For 120 V models)

This digital apparatus does not exceed the Class B limits for radio noise emissions from digital apparatus as set out in the interference-causing equipment standard entitled " Digital Apparatus", ICES-003 of the Industry Canada.

## RÈGLEMENT SUR LE BROUILLAGE RADIOÉLECTRIQUE (For 120 V models)

Cet appareil numérique respecte les limites de bruits radioélectriques applicables aux appareils numériques de Classe B prescrites dans la norme sur le matériel brouilleur: " Appareils Numériques", NMB-003 édictée par l'Industrie Canada.



## International ENERGY STAR® Office Equipment Program



As an ENERGY STAR® Partner, CANON ELECTRONICS INC. has determined that this machine meets the ENERGY STAR® Program guidelines for energy efficiency.

The International ENERGY STAR® Office Equipment Program is an international program that promotes energy saving through the use of computers and other office equipment. The program backs the development and dissemination of products with functions that effectively reduce energy consumption. It is an open system in which business proprietors can participate voluntarily. The targeted products are office equipment, such as computers, monitors, printers, fax, machine, copiers, and scanners. The standards and logos are uniform among participating nations. This model doesn't provide "setting options" for power management.

## European Union (and EEA) only.



This symbol indicates that this product is not to be disposed of with your household waste, according to the WEEE Directive (2002/96/EC) and your national law. This product should be handed over to a designated collection point, e.g., on an authorized one-for-one basis when you buy a new similar product or to an authorized collection site for recycling waste electrical and electronic equipment (EEE). Improper handling of this type of waste could have a possible negative impact on the environment and human health due to potentially hazardous substances that are generally associated with EEE. At the same time, your cooperation in the correct disposal of this product will contribute to the effective usage of natural resources. For more information about where you can drop off your waste equipment for recycling, please contact your local city office, waste authority, approved WEEE scheme or your household waste disposal service. For more information regarding return and recycling of WEEE products, please visit [www.canon-europe.com/environment](http://www.canon-europe.com/environment).

(EEA: Norway, Iceland and Liechtenstein)

## Für EMVG

Dieses Produkt ist zum Gebrauch im Wohnbereich, Geschäfts-und Gewerbebereich sowie in Kleinbetrieben vorgesehen.

## Model Names

The following names may be provided for the safety regulations in each sales region of the Document Scanner.

DR-C225W II: Model 6130060

DR-C225 II: Model 6130050



Módulo WLAN instalado adentro de producto

MARCA: Canon

MODELO: SX-SDMGN

IFETEL: RCPCASX14-2029

SX-SDMGN RCPCASX14-2029

La operación de este equipo está sujeta a las siguientes dos condiciones:

(1) es posible que este equipo o dispositivo no cause interferencia perjudicial y (2) este equipo o dispositivo debe aceptar cualquier interferencia, incluyendo la que pueda causar su operación no deseada.

## Reproduction Warning

This device is designed to be used in a legal manner, in accordance with all applicable laws, including, but not limited to, counterfeit and copyright laws, as well as laws pertaining to national security.

Any person(s) found to have reproduced any of the following materials (regardless of whether such reproduction was intentional or not) for the purpose of misrepresenting such material as the original may be prosecuted in accordance with the applicable laws and regulations.

- Paper money or bank notes (domestic and foreign)
- Postage stamps, revenue stamps, or other similar stamps
- Stock certificates, bond certificates, promissory notes, cheques, or other valuable certificates
- Passports, licenses, or other certificates or documents issued by government officials or agencies

This is not an exhaustive list.

Canon is not responsible for how this scanner is used by an individual. Please note that certain intellectual property is protected by copyright law, and copyrighted items may not be reproduced without the express permission of the copyright holder except for personal or household use under limited circumstances.

## Disclaimers

The information in this document is subject to change without notice.

CANON ELECTRONICS INC. MAKES NO WARRANTY OF ANY KIND WITH REGARD TO THIS MATERIAL, EITHER EXPRESS OR IMPLIED, EXPECT AS PROVIDED HEREIN, INCLUDING WITHOUT LIMITATION, THEREOF, WARRANTIES AS TO MARKETABILITY, MERCHANTABILITY, FITNESS FOR A PARTICULAR PURPOSE OF USE OR NON-INFRINGEMENT. CANON ELECTRONICS INC. SHALL NOT BE LIABLE FOR ANY DIRECT, INCIDENTAL, OR CONSEQUENTIAL DAMAGES OF ANY NATURE, OR LOSSES OR EXPENSES RESULTING FROM THE USE OF THIS MATERIAL.

CANON ELECTRONICS INC. IS NOT LIABLE FOR THE STORAGE AND HANDLING OF DOCUMENTS SCANNED WITH THIS PRODUCT, OR THE STORAGE AND HANDLING OF RESULTING SCANNED IMAGE DATA.

IF YOU INTEND TO DISCARD THE ORIGINALS OF SCANNED DOCUMENTS, YOU THE CUSTOMER ARE RESPONSIBLE FOR INSPECTING THE SCANNED IMAGES AND VERIFYING THAT DATA IS INTACT.

THE MAXIMUM LIABILITY OF CANON ELECTRONICS INC. UNDER THIS WARRANTY IS LIMITED TO THE PURCHASE PRICE OF THE PRODUCT COVERED BY THE WARRANTY.

## Trademarks

---

- Canon and the Canon logo are registered trademarks, of Canon Inc. in the United States and may also be trademarks or registered trademarks in other countries.
- imageFORMULA is a trademark of CANON ELECTRONICS INC.
- Microsoft, Windows, PowerPoint, and SharePoint are registered trademarks or trademarks of Microsoft Corporation in the United States and other countries.
- Microsoft product screen shot(s) reprinted with permission from Microsoft Corporation.
- OS X and macOS are the trademarks of Apple Inc., registered in the U.S. and other countries.
- ENERGY STAR® is a registered trademark of the United States Environmental Protection Agency.
- ISIS is a registered trademark of Emc Corporation in the United States.
- Other product and company names herein may be the trademarks of their respective owners. However, the ™ and ® symbols are not used in this document.

## Copyright

Copyright 2018 by CANON ELECTRONICS INC. All rights reserved.

No part of this publication may be reproduced or transmitted in any form or by any means, electronic or mechanical, including photocopying and recording, or by any information storage or retrieval system without the prior written permission of CANON ELECTRONICS INC.

## Chapter 2 Important Safety Instructions

To ensure the safe operation of this scanner, be sure to read the safety warnings and precautions described below.

Installation Location.....	10
AC Adapter .....	11
Moving the Scanner.....	11
Handling .....	12
Disposal.....	13
When sending the scanner for repairs .....	13

## Installation Location

The performance of this scanner is affected by the environment in which it is installed. Make sure that the location where the scanner is installed meets the following environmental requirements.

- Provide adequate space around the scanner for operation, maintenance, and ventilation.

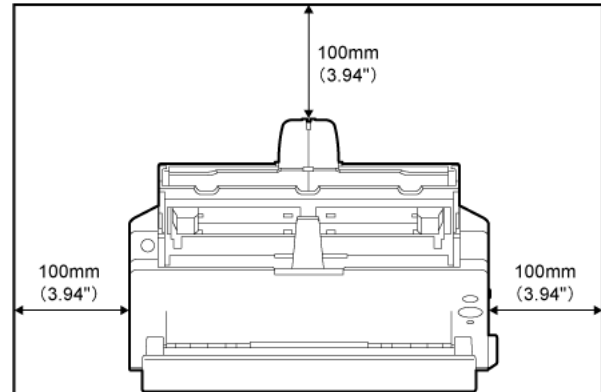

- When scanning documents using the straight path, provide adequate space in front of the scanner for scanned document output.
- Avoid installing the machine in direct sunlight. If this is unavoidable, use curtains to shade the scanner.
- Avoid locations where a considerable amount of dust accumulates.
- Avoid warm or humid locations, such as in the vicinity of a water faucet, water heater, or humidifier. Avoid locations where ammonia gas is emitted. Avoid locations near volatile or flammable materials, such as alcohol or paint thinner.
- Avoid locations that are subject to vibration.
- Avoid exposing the scanner to rapid changes in temperature. If the room in which the scanner is installed is cold but rapidly heated, water droplets (condensation) may form inside the scanner. This may result in a noticeable degradation in scanning quality. The following conditions are recommended for optimal scanning quality:

Room temperature: 10°C to 32.5°C (50°F to 90.5°F)

Humidity: 25% to 80% RH

- Avoid installing the scanner near equipment that generates a magnetic field (e.g. speakers, televisions, or radios.)

## AC Adapter

---

---

- Connect only to a power outlet of the rated voltage and power supply frequency (120 V, 60 Hz or 220-240 V, 50/60 Hz depending on your region).
- Do not connect other electrical equipment to the same power outlet to which the scanner is connected. Also, when using an extension cord, make sure that the extension cord is rated for the current requirements of the scanner.
- Never try to take the AC adapter apart or modify it in any way, as this is dangerous.
- The power cord may become damaged if it is often stepped on or if heavy objects are placed on it.
- Do not use the power cord while it is coiled.
- Do not pull directly on the power cord. When disconnecting the power cord, grasp the plug and remove it from the outlet.
- Keep the area around the power cord clear of objects so that the power cord can be disconnected easily in an emergency.
- Do not use an AC adapter other than the one provided with the scanner. Do not use the AC adapter provided with the scanner with other products.
- If you have any questions regarding the power supply, contact your local authorized Canon dealer or service representative for further information.

## Moving the Scanner

---

---

- When moving the scanner, always hold it with both hands to avoid dropping it.
- Make sure to disconnect the interface cable and AC adapter before moving the scanner. If the scanner is transported with these items connected, the plugs and connectors may be damaged.

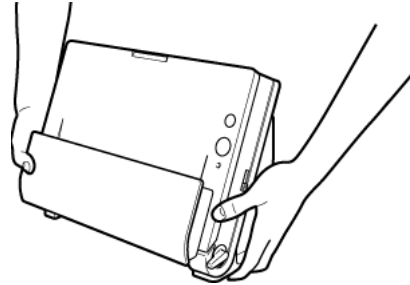

## Handling

---



### WARNING

Note the following precautions whenever using the scanner. Failure to do so may result in a fire or electric shock.

- Never place alcohol, benzene, paint thinner, or other flammable substances near the scanner.
- Do not cut, damage, or modify the power cord. Do not place heavy objects on the power cord, and do not pull or excessively bend the power cord.
- Never connect the power cord when your hands are wet.
- Do not connect the scanner to a multi plug power strip.
- Do not knot or coil the power cord as this may result in a fire or electric shock. When connecting the power cord, make sure that the power plug is securely and completely inserted into the power outlet.
- The supplied power cord set is intended for use with this scanner only. Do not use it with other electronic equipment. In addition, do not use power cord sets other than the one supplied with the scanner. Doing so may result in fire or electric shock.
- Do not take the scanner apart or modify it.
- Never try to take the AC adapter apart or modify it in any way, as this is dangerous.
- Do not use flammable spray near the scanner.
- When cleaning the scanner, push the power button to turn it OFF and disconnect the power cord from the power supply.
- Clean the scanner using a slightly dampened cloth which has been well wrung out. Never use alcohol, benzene, paint thinner, or any other flammable substances.
- If the scanner makes strange noises, or gives off smoke, heat, or strange odors, or the scanner does not function or other abnormalities occur when you use the machine, immediately push the power button to turn it off, and disconnect the power plug from the power outlet. Then, contact your local authorized Canon dealer or service representative to have the unit serviced.
- Do not drop the scanner, or subject it to impact or strong shock. Should the scanner ever become damaged, immediately push the power button to turn it OFF, and disconnect the power plug from the

power outlet. Then, contact your local authorized Canon dealer or service representative to have the unit serviced.

- Before moving the scanner, be sure to push the power button to turn it OFF, and disconnect the power plug from the power outlet



### CAUTION

- Do not install the scanner on a surface that is unstable, tilted, or subject to excessive vibrations. Doing so may cause the scanner to fall, resulting in personal injury or damage to the scanner.
- Never place small metal objects such as staples, paper clips, or jewelry on the scanner. These items may fall into the scanner, and cause a fire or electric shock. Should such objects ever fall inside the scanner, immediately push the power button to turn it OFF, and disconnect the power plug from the power outlet. Then, contact your local authorized Canon dealer or service representative to have the unit serviced.
- Do not install the scanner in a humid or dusty location. Doing so might cause a fire or electric shock.
- Do not place objects on top of the scanner. Such objects may tip or fall over, resulting in personal injury.
- Connect only to a power outlet of the rated voltage and power supply frequency (120 V, 60 Hz or 220-240 V, 50/60 Hz depending on your region).
- When unplugging the power cord, grasp it firmly by its plug. Do not pull directly on the power cord, as this may damage or expose the cord's internal wiring, resulting in a fire or electric shock.
- Leave sufficient space around the power plug so that it can be unplugged easily. If objects are placed around the power plug, you will be unable to unplug it in an emergency.
- Do not allow water or flammable substances (alcohol, paint thinner, benzene, etc.) to spill into the scanner, as this may result in a fire or electric shock.
- Push the power button to turn the scanner OFF for safety when not using the scanner for a long period of time, such as overnight. Also, push the power switch to turn it OFF, and disconnect the power cord from the power outlet for safety when the machine will not be used for an extended period of time, such as during consecutive holidays.

- Do not wear loose clothing or jewelry that may get caught in the scanner while you are using it. This may result in personal injury. Be extra careful of neckties and long hair. If anything becomes caught in the scanner, immediately disconnect the power cord to stop the scanner.
- Be careful when loading paper into the scanner and when removing jammed paper. It is possible to cut your hand on the edge of a sheet of paper.

## **Disposal**

---

---

When disposing of this scanner, be sure to follow all local ordinances and laws or consult with the retailer who sold you the scanner.

## **When sending the scanner for repairs**

---

---

When a request is made for repairs, the scanner needs to be sent to the specified address. When sending the scanner, use the packing box in which it came. Firmly secure the scanner with packaging material when you place it in the packing box.

## Chapter 3 Installing the Software

This section describes the software installation procedure using the setup disk (DVD) that comes with this product.

<b>System requirements .....</b>	<b>14</b>
<b>Setup Disc Contents.....</b>	<b>15</b>
<b>Software Installation.....</b>	<b>16</b>

## System requirements

**To use the scanner, your computer must satisfy the following system requirements.**

- Computer
  - CPU: Intel Core 2 Duo 1.66GHz or faster **Windows**  
Intel Core i7 2.3GHz or faster **Mac**
  - Memory: 1 GB or more **Windows**  
8 GB or more **Mac**
  - Hard disk: 3 GB or more available space required for installation of all software
  - USB interface: Hi-Speed USB2.0
  - Monitor: Resolution of 1024 × 768 (XGA) or better recommended. **Windows**
  - Optical drive: Drive capable of reading CDs/DVDs.  
**Windows**
- Operating system
  - Microsoft Windows 7 Service Pack 1 or later (32-bit and 64-bit editions)
  - Microsoft Windows 8.1 (32-bit and 64-bit editions)
  - Microsoft Windows 10 (32-bit and 64-bit editions)
  - Microsoft Windows Server 2008 R2 Service Pack 1 or later
  - Microsoft Windows Server 2012 R2
  - Microsoft Windows Server 2016
  - OS X 10.11\*
  - macOS 10.12
  - macOS 10.13

This is the environment as of May 2018.

For the latest software support information, go to the Products page on the Canon website.

\* Our wireless connection application software bundled with the DR-C225W II, "NetworkMonitor" and "Wireless Connection Setup Tool" are compatible with Mac OS 10.10 and 10.12.2 or later, and do NOT support any other OS. If you are using 10.12.2 or later, please use the software versions mentioned below or any higher version.

NetworkMonitor: 1.4.0.342

Wireless Connection Setup Tool: 1.4.0.30

- Other requirements
  - An ISIS-compatible application (Windows only) or a TWAIN-compatible application that is compatible with the above operating systems.
  - .NET Framework 4.0 or later (Windows only)



## IMPORTANT

- **Use the USB interface provided as standard with your computer. However, normal operation is not guaranteed with all USB interfaces, even if present as standard equipment on the computer. For details, consult your local authorized Canon dealer.**
- **Scanning speeds are lower if your computer's standard USB interface is USB Full-Speed (equal to USB 1.1.)**
- **The USB cable you are using should be the one originally included with the scanner.**
- **If the CPU, memory, interface card, and other specifications do not satisfy the installation requirements, the scanning speed may be greatly reduced and transmission may take a long time.**
- **Even if the computer satisfies the system requirements, the scanning speed may vary, depending on the specification of the computer and the environment.**
- **The scanner drivers provided with the scanner do not necessarily operate on all ISIS or TWAIN-compatible applications. For details, contact your application software retailer.**
- **In Windows 10 tablet mode, the software may disrupt the display.**
- **The Desktop Experience feature must be enabled for Windows Server 2008 R2 and Windows Server 2012 R2.**

### Precautions for Use in 64-bit Operating Systems (Windows only)

- **The ISIS/TWAIN driver supplied with this product supports scanning with 32bit applications only.**
- **Even with 32-bit applications, not all ISIS/TWAIN compliant applications are guaranteed to operate.**
- **Scanning speed may vary depending on the specifications of your computer.**

## Setup Disc Contents

**Install the following software necessary for using the scanner from the supplied Setup Disc.**

- **CaptureOnTouch**  
This is a dedicated scanning utility for this product.
- **Scanner Driver**  
This is the scanner driver for this product.
- **Wireless Connection Setup Tool (DR-C225W II only)**  
This is a utility for setting up connections to computers using the product's Wi-Fi function.
- **NetworkMonitor (DR-C225W II only)**  
This utility supports automatic connections to the scanner on a network. When connecting a different device to the scanner, disconnection and reconnection can be performed automatically.



## CAUTION

**When scanning with third-party software, use the scanner driver of this scanner to configure scanning conditions. For details on how to open the scanner driver, refer to the manuals supplied with each software application.**

### Cloud Service Software

For some of the supplied third-party software, a cloud service account is required to use some or all of their functions.

Software	Cloud service used
CaptureOnTouch plug-in for Google Drive	Google Drive
CaptureOnTouch plug-in for Dropbox	Dropbox
CaptureOnTouch plug-in for SugarSync	SugarSync
CaptureOnTouch plug-in for Microsoft OneDrive	Microsoft OneDrive

You will be asked to agree to terms of service when obtaining an account. For details, refer to the website of your cloud service provider.

Simple installation of the above software does not require an account.



## Software Installation

→ Windows

→ Mac

Windows



### IMPORTANT

Install the software before connecting the scanner to the computer.

- Log on to Windows as an Administrator.
- Close all other applications before installing the software.

#### 1 Insert the Setup Disc into the disc drive of the computer.

The setup menu automatically starts up when you insert the disc into the drive. (If the menu does not start up, execute setup.exe from the disc.)

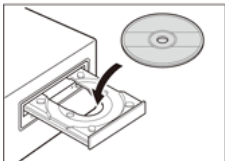

If the following screen appears, click [Yes] or [Permissions].

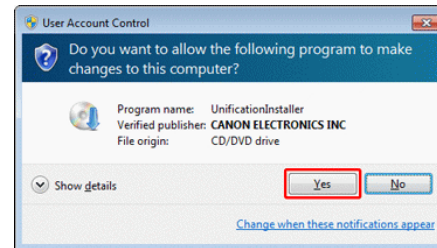

#### 2 Click [Typical Installation].

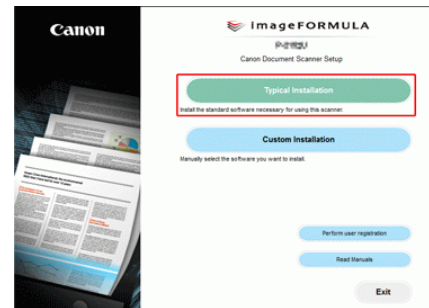

### NOTE

If you want to reinstall only specific software that you have previously uninstalled, select [Custom Installation] and specify the software.

### 3 Click [Install].

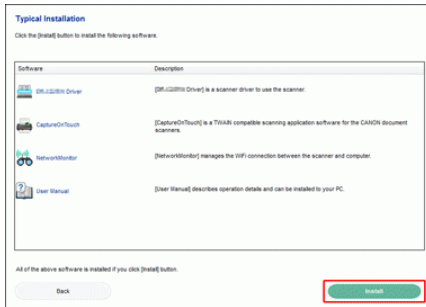

### 4 Follow the instructions on the screen to complete installation.

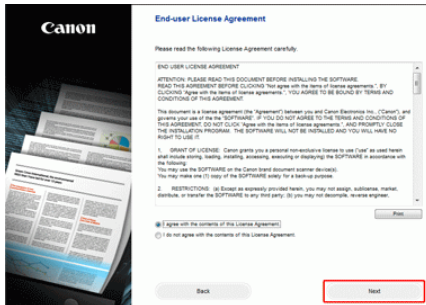

### 5 Click [Exit] to finish installing the software.

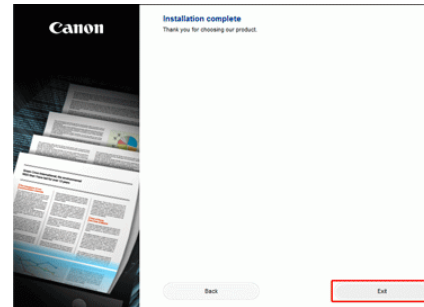

\* Download the latest software for Windows from the Canon website. (See the sheet included with the scanner for the URL.)



**IMPORTANT**

Install the software before connecting the scanner to the computer.

- **Close all other applications before installing the software.**

1 Download the software installer (dmg file) from the website. The scanner driver and CaptureOnTouch have different installers. (See the sheet included with the scanner for the URL.)

2 Double-click the downloaded dmg file to start the installer.

3 For the scanner driver, click [DR-C225 Installer.pkg].

\* For CaptureOnTouch, click [CaptureOnTouch Installer.pkg].



4 Follow the instructions on the screen to complete installation.

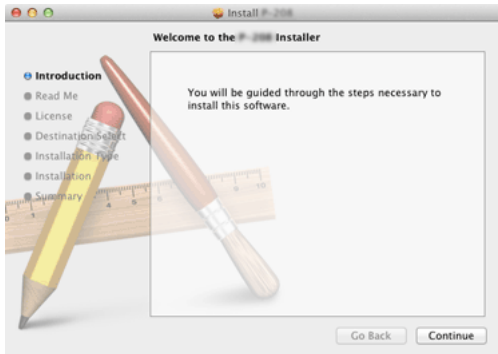

5 When the installation is complete, click [Log out].

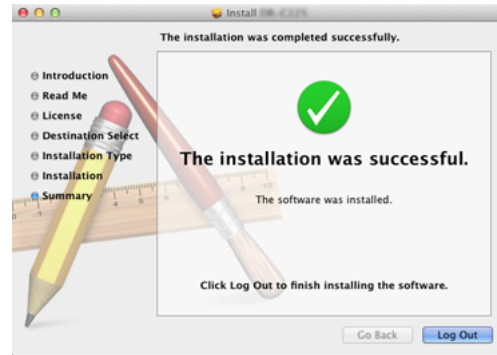

## NOTE

To operate the scanner using a wireless connection, double-click [Canon NetworkMonitor Installer] in step 2 of the above procedure, and follow the instructions on the screen to install the software (Wireless Connection Setup Tool and NetworkMonitor). You must restart the computer after installation. After restarting the computer, follow the instructions in the "Wi-Fi Connection Guide" (stored on the Setup Disc) to configure wireless settings.

## Chapter 4 Connecting the Scanner

Connect the scanner to the computer and power outlet.

**Connecting the Scanner to the Computer**..... 19

**Turning the Power ON**..... 20

## Connecting the Scanner to the Computer

Connect the scanner to the computer and the power supply.

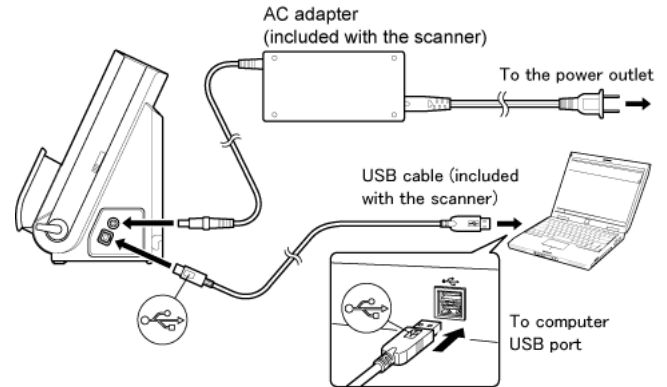

### IMPORTANT

- Do not connect the scanner to the computer before installing the software.
- Before connecting the scanner to the computer, verify that the power of the scanner is OFF. If the power is ON, turn it OFF.



## NOTE

You can secure the cables to the back of the scanner. Make sure there is sufficient slack in the cable when doing so to reduce stress on the connector.

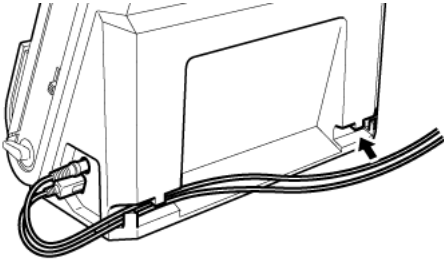

## Turning the Power ON

The power of the scanner can be turned ON and OFF with the power button on the front of the scanner.

- 1 Make sure that the scanner and computer are connected properly.
- 2 Press the power button.

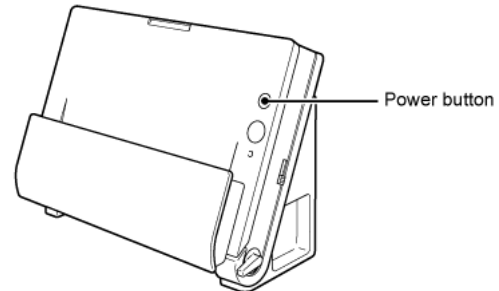

The power button lights blue when the power turns ON.



NOTE

### Windows

When the scanner is turned on for the first time, the balloon message shown below appears on the Windows task bar. If you wait a while, automatic scanner recognition will end and the scanner will become ready to use.

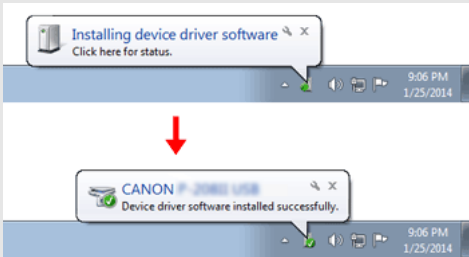



When the scanner is properly connected to the computer, the (CaptureOnTouch) icon appears on the taskbar as follows.

### Windows



### Mac



If the taskbar icon appears as  or  the scanner is not properly connected to the computer. Check the status of the power and USB cable.

## Turning Off the Power

Press and hold the power button until the indicator goes out.



IMPORTANT

- After turning the scanner off, wait at least 10 seconds before turning it back on.
- If you will not be using the scanner for an extended period, you should disconnect the power cord from the AC outlet for safety.



NOTE

The scanner's auto power off setting is enabled by default, and the scanner will turn off automatically if it is not operated for 4 hours. For details on how to disable this setting, see " Auto Power Off Setting" on p.98 .

# Chapter 5 Placing Documents

This section describes how to load a document for scanning.

- Documents ..... 22**
- Switching the Feed and Eject Methods ..... 24**
- Placing Documents for Standard Feeding ..... 24**
- Placing Documents for Non Separation Feeding ..... 27**
- Placing Cards..... 29**
- Placing Folded Documents..... 30**
- Setting the Long Document Mode ..... 32**

## Documents

---

---

**The scanner can scan documents ranging in size from business cards to Legal/A4. The document sizes that this scanner can scan are shown below.**

Plain Paper

Size

Width: 50.8 mm to 216 mm (2" to 8.5" )

Length: 53.9 mm to 356 mm (2.12" to 14" )\*

Paper weight

When U-turn path: 52 to 128 g/m<sup>2</sup> (14 to 34 lb bond)

0.06 to 0.15 mm (0.0024" to 0.0059" )

When straight path: 40 to 209 g/m<sup>2</sup> (11 to 58 lb bond)

0.05 to 0.25 mm (0.002" to 0.0098" )

\* Setting the scanner to Long Document mode enables documents up to 3,000 mm (118.1" ) long to be scanned. For details on Long Document mode, refer to "Setting the Long Document Mode" on p.32.

Loading capacity

Approx. 30 sheets (80 g/m<sup>2</sup> (22 lb bond))

Make sure stacks do not exceed 6 mm in height



## IMPORTANT

A document must meet the following criteria to be scannable:

- **When scanning multiple documents of different sizes, place the documents so that they cover the entire span of the feed rollers.**

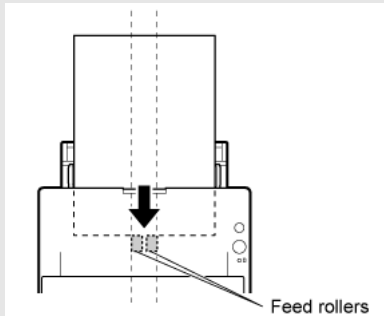

- **It is recommended that documents exceeding 356 mm (14") in size are fed one sheet at a time.**
- **Scanning documents before the ink is dry can cause problems with the scanner. Always make sure that the ink on a document is dry before scanning it.**
- **Scanning documents that are written in pencil or similar material may make the rollers and scanning glass dirty, which can lead to smudges on the scanned image and transfer the dirt to subsequent documents. Always clean the internal parts of the scanner after scanning such documents.**
- **When scanning a two-sided document that is printed on thin paper, the image on the opposite side of each page may show through. In this case, adjust the scanning intensity in the application software before scanning the document.**
- **It is recommended that thin documents are fed one sheet at a time.**

Scanning the following types of documents can cause a paper jam or malfunction. To scan such a document, make a photocopy of the document and then scan the photocopy.



Wrinkled or creased documents



Carbon paper



Curled documents



Coated paper



Torn documents



Extremely thin, translucent paper



Documents with paper clips or staples



Documents with excessive paper dust particles.

### Business Card

Size: 50.8 mm x 53.9 mm (2" x 2.12") or larger

Paper weight: 300 g/m<sup>2</sup> (80 lb bond) 0.35 mm (0.0138") or less

Orientation: Vertical feeding only



## IMPORTANT

**If a stack of business cards cannot be fed properly, reduce the number of cards in the stack.**

### Card (plastic or laminated)

Size: 53.9 mm x 85.5 mm (2.12" x 3.37") (ISO standard)

Card thickness: 0.76 mm (0.03") or less, 1.4 mm (0.055") or less for the embossment

Orientation: Horizontal feeding only

Feed path: Straight path only

Embossed cards can be scanned.



## CAUTION

- Use the straight path when scanning cards.
- If you place cards to be fed vertically, they may not be ejected properly, and cards that get jammed may be damaged when you remove them. Take care of the orientation when placing cards.
- Embossed cards may not be able to be scanned correctly, depending on the type of embossment.



## Switching the Feed and Eject Methods

Use the two levers on the scanner to switch the feed and eject methods based on the type of document you are scanning.

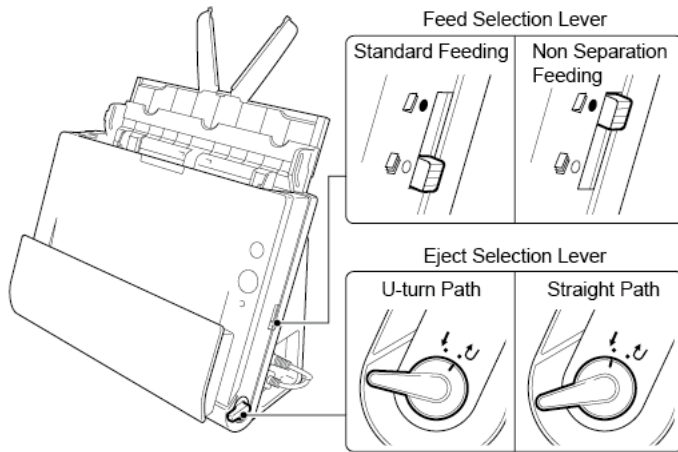

The feed and eject methods and lever positions for each document type are as follows.

Document type	Feed method (lever position)	Eject method (lever position)
Standard paper and business cards	Standard feeding (lower)	U-turn path (upper) or straight path (lower)
Plastic cards, thick paper, thin paper, and bound or fastened paper	Non separation feeding (upper)	Straight path (lower)

## Placing Documents for Standard Feeding

Ordinarily, standard feeding should be used when scanning multiple documents of a standard size at one time. Standard feeding enables the multiple documents to be fed while separating each page.

- 1 Open the document feed tray.

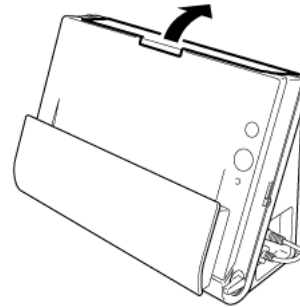

- 2 Pull out the feed support.

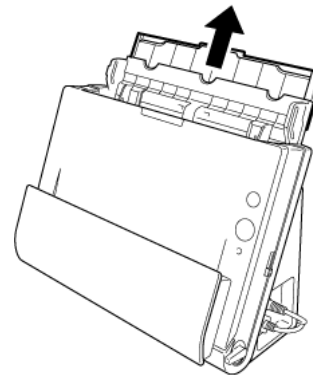

- 3** When scanning long documents, pull out the feed extension plates and eject support.

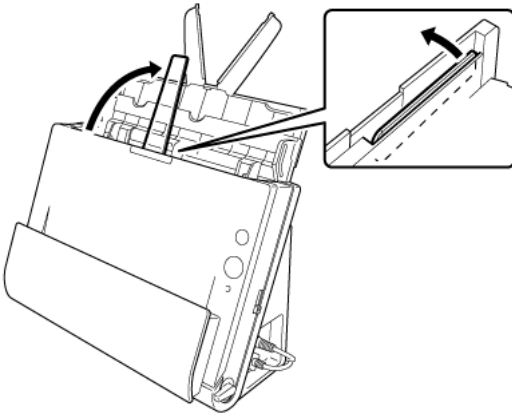
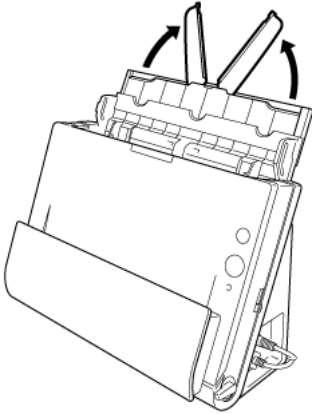

- 4** Set the feed selection lever and the eject selection lever.

Set the feed selection lever to the standard feeding position (lower position).  
Set the eject selection lever to the U-turn path position (↺).

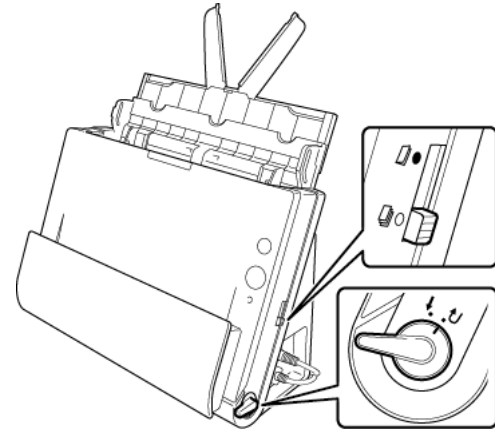

When scanning documents that contain both standard paper and plastic cards, use the straight path.

- 5** Adjust the document guides to fit the width of the document to be scanned.

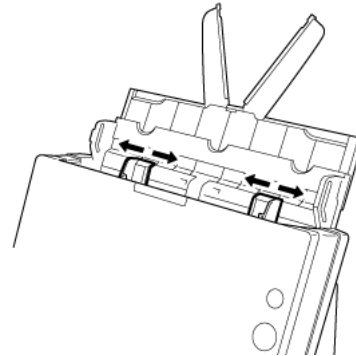

## 6 Place the document.

Insert the document in the feed tray so that the front is facing forward and the top is facing upward.

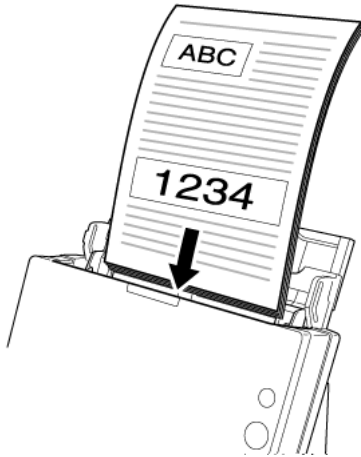

After inserting the document in the document feeder, align the document guides with both edges of the document.

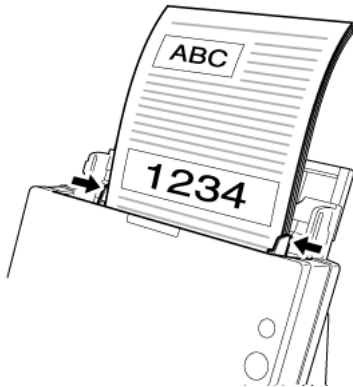

## IMPORTANT

- When placing documents into the feed tray, take care not to cut your hands on the edges of the paper.
- Make sure that the document does not exceed the loading limit marks (▼) on the document guides. Up to 30 pages of ordinary plain paper (80 g/m<sup>2</sup>) can be loaded at the same time.
- Before you place a document, check to make sure it does not contain paper clips, staples, or other small metal objects. These items may cause a fire or electrical shock, damage the document, or cause a paper jam or scanner malfunction.
- Do not wear loose clothing or jewelry that may get caught in the scanner while you are using it. This may result in personal injury. Be extra careful of neckties and long hair. If anything gets caught in the scanner, immediately turn OFF the power switch, and disconnect the power cord from the power outlet to stop scanning.
- Always smooth out any folds or curls in your documents before placing them into the feeder. If the leading edge of a document is curled, it may cause a paper jam.
- If feeding stops due to a system error or paper jam while the scanner is scanning, resolve the problem, make sure that the scanned image of the last page that was successfully fed has been stored, and then resume scanning the remaining document pages.
- After you finish scanning, close the document feed tray to prevent damage to the scanner while it is not being used.
- Although standard feeding can be used in combination with the straight path when scanning, multi-page documents will be ejected in reverse order in such cases.

- If you select the [Upside-down feeding] check box in the scanner driver settings, you can insert documents into the scanner in the opposite orientation ("When you want to scan a document placed upside-down" on p.76 )

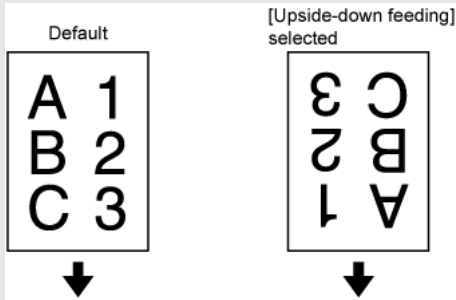

## Placing Documents for Non Separation Feeding

When scanning a thick document one page at a time or scanning a document that has multiple pages fastened together, set document feeding to non separation mode. This enables the placed document to be scanned without the pages being separated, regardless of the number of pages.

### 1 Set the feed selection lever and the eject selection lever.

Set the feed selection lever to the non separation position (upper position). The feed selection indicator will light white.

Set the eject selection lever to the straight path position (↯).

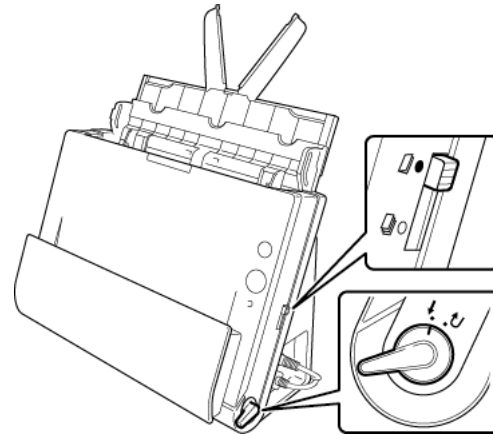

- 2 Adjust the document guides to fit the width of the document.

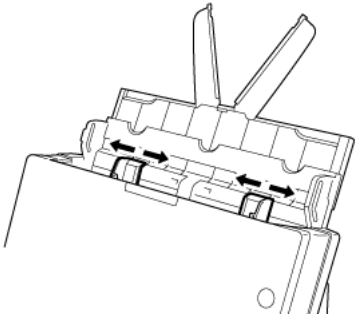

- 3 Place the document in the document feed tray.



## IMPORTANT

- With the straight path, documents are ejected at the front of the scanner. Do not place anything that will block output near the document eject area. Also, install the scanner on a smooth surface to enable documents to be smoothly ejected.

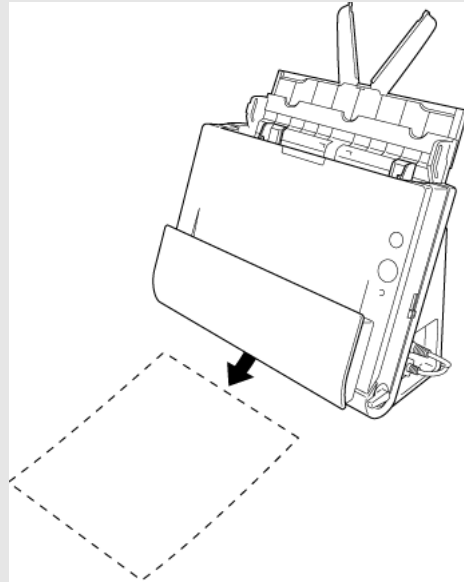

- When scanning multiple page documents that are fastened together, such as invoices, place the documents so that the edge that is fastened together is facing down.

## Placing Cards

---

### 1 Set the feed selection lever and the eject selection lever.

Set the feed selection lever to the non separation position (upper position). The feed selection indicator will light white.

Set the eject selection lever to the straight path position (⚡).

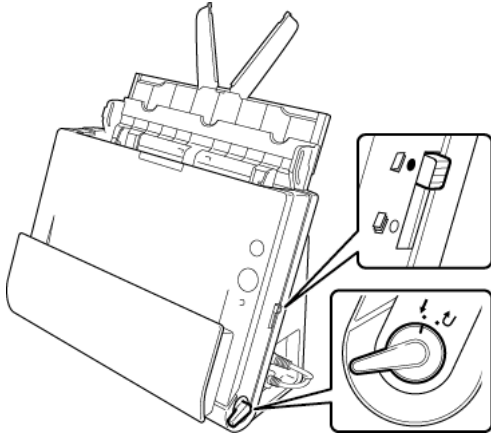

### 2 Adjust the document guides to fit the width of the card to be scanned.

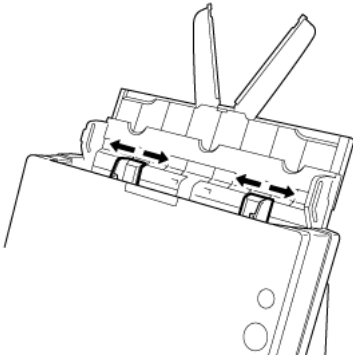

### 3 Place the card horizontally with the top edge facing upward.

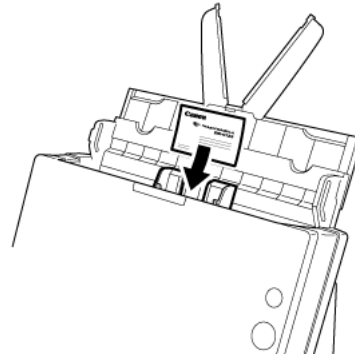

### ! CAUTION

- Place the card one at a time.
- If you place cards to be fed vertically, they may not be ejected properly, and cards that get jammed may be damaged when you remove them. Take care of the orientation when placing cards.

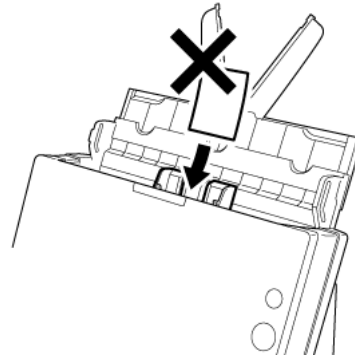

- Ultrasonic double feed detection will not function properly when scanning cards. Clear the [Detect by Ultrasonic] check box in the [Feeding] tab.



## IMPORTANT

With the straight path, documents are ejected at the front of the scanner. Do not place anything that will block output near the document eject area. Also, install the scanner on a smooth surface to enable documents to be smoothly ejected.

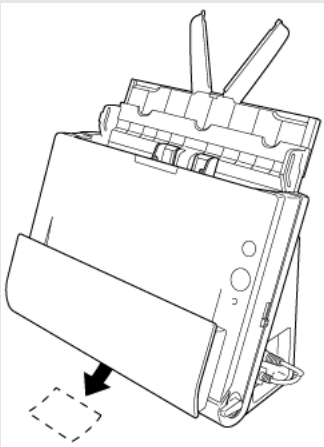

## Placing Folded Documents

Folio Scan enables you to scan documents that are larger than LTR/A4 and therefore do not fit in the feeder. To use the function, fold the document in half lengthwise and place it into the feeder. The DR-C225 will scan both sides and combine the scanned images into a single image.

### 1 Set the feed selection lever and the eject selection lever.

Set the feed selection lever to the non separation position (upper position). The feed selection indicator will light white.

Set the eject selection lever to the straight path position (↴).

### 2 Fold the document in half.

Align the left and right sides of the document, and create the document firmly. If the document is not folded properly, paper jams may occur or distortions may appear in the combined scanned image.



## IMPORTANT

A portion of the scanned image will be missing at the fold line.

### 3 Place the document in the document feed tray.

Under default conditions, place the document with the folded edge facing right. If the [Upside-down feeding] check box is selected in the scanner driver settings, place the document with the folded edge facing left.

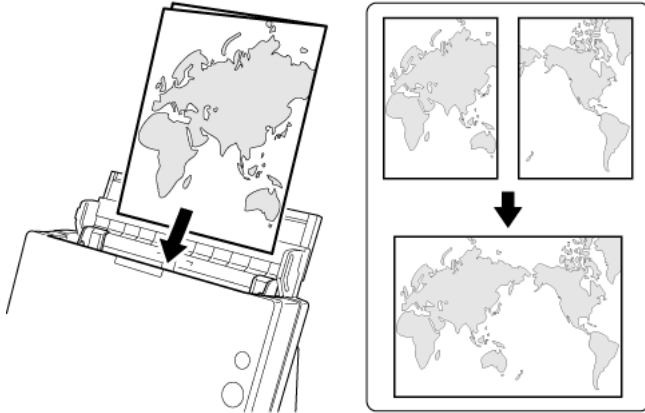

#### NOTE

Set the scanning condition for folded documents on advanced settings dialog box of the scanner driver. You cannot set the condition by CaptureOnTouch.



#### IMPORTANT

Adjust the document guides to fit the width of the document. Otherwise, the image may scan as skewed or shifted.



#### NOTE

- The side of the folded document that is facing forward will be the left side of the combined image.
- The maximum size for the combined image is A2.

### Setting Scanning Conditions

Configure scanning conditions as follows when scanning folded documents.



## Scanner driver (Windows)

Configure the following settings in the [Basic] tab. (" Confirming Basic Conditions for Scanning" on p.62 )

- Set [Page Size] to half the size of the document (set to [Match original size] when scanning an atypical document size)
- Set [Scanning Side] to [Folio].

## Scanner driver (OS X/macOS)

Configure the following settings. (" Page Size" on p.64)

- Set [Page Size] to half the size of the document (set to [Detect automatically] when scanning an atypical document size)
- Set [Scanning Side] to [Folio].

## Setting the Long Document Mode

The length of documents that can be scanned with the scanner is normally 356 mm (14" ), but you can scan documents up to 3,000 mm (118.1" ) long by setting the scanner to the Long Document mode.

## Windows

- 1 Start Windows and log in as a user with administrator privileges.
- 2 Click the Start button, and then click [All Programs], [Canon DR-C225], and [Canon imageFORMULA Utility].  
imageFORMULA Utility starts.

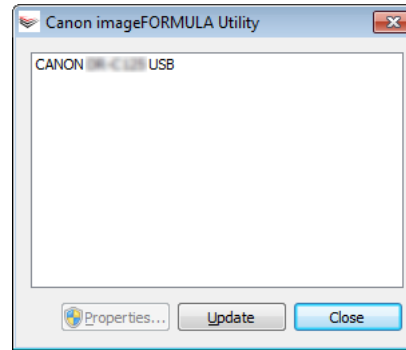

### IMPORTANT

Note the following when using the Long Document mode:

- When scanning in the Long Document mode, if the document is placed on the scanner in a skewed position, it may hit the edges of the feeding area and be damaged. Be careful to place the document so that it is not skewed.
- When scanning with the Long Document mode, paper jam detection may react slowly, resulting in damage to the document. Be careful to avoid paper jams.
- When scanning long documents, make sure to set the feed selection lever to the non separation position, and scan the documents one at a time.
- When scanning large-sized documents with the Long Document mode, scanning may be slower. Errors may also occur due to memory shortage and scanning may be disabled.
- Scanning in the Long Document mode is supported only during USB connections.

**3 Click [CANON DR-C225 USB] and click [Properties].**

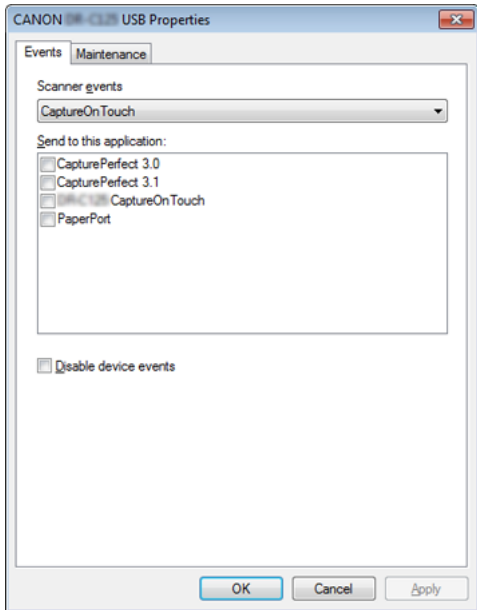

(The [Events] tab may not be displayed, depending on the model.)

**4 Click the [Maintenance] tab, and then select a Long Document mode.**

Select [Long Document mode (1,000 mm)] or [Long Document mode (3,000 mm)] depending on the length of the document.

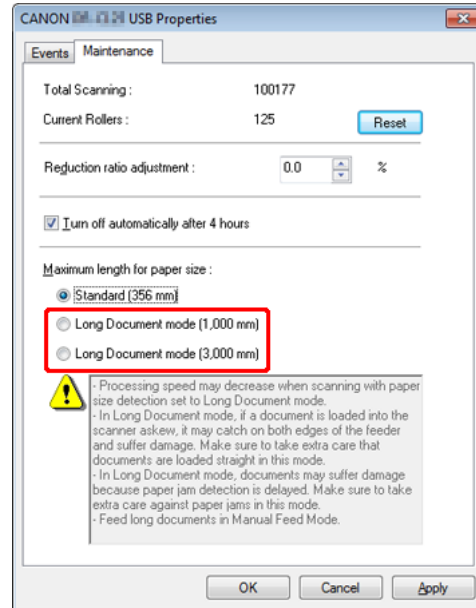

**5 Click [OK].**

### Setting Scanning Conditions

Configure scanning conditions as follows when scanning documents in Long Document mode.

#### CaptureOnTouch

Set [Page Size] to [Match original size] under [Scanner setting]. ("Select document settings" on p.51 )

#### Scanner driver

Set [Page Size] to [Match original size] in the [Basic] tab. ("Confirming Basic Conditions for Scanning" on p.62 )



**1 Opens the scanner driver's Detail Settings screen.**

See " Select document settings" on p.51.  
This will open the advanced settings dialog box for the scanner.

**2 Click  to display the [Scanner Information] dialog box.**

The [Scanner Information] dialog box appears.

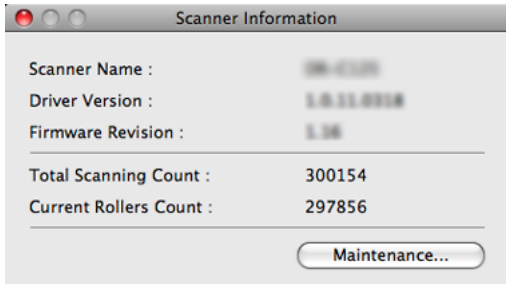

**3 Click [Maintenance].**

The [Maintenance] dialog box appears.

**4 Select [Long Document mode (1,000 mm)] or [Long Document mode (3,000 mm)] depending on the length of the document.**

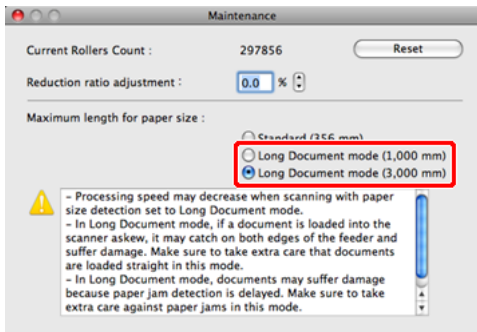

**5 Click  to close the dialog box.**

### Setting Scanning Conditions

Configure scanning conditions as follows when scanning documents in Long Document mode.

### CaptureOnTouch

Set [Page Size] to [Match original size] under [Scanner setting]. (" Select document settings" on p.51 )

### Scanner driver

Set [Page Size] to [Detect automatically]. (" Page Size" on p.64)

# Chapter 6 Scanning with CaptureOnTouch

This section describes the scanning procedure when using CaptureOnTouch.

- What is CaptureOnTouch? ..... 35**
- Starting and Exiting CaptureOnTouch ..... 37**
- Selecting a scanner ..... 39**
- Screen Descriptions ..... 40**
- Standard Scanning ..... 40**
- Scanning Shortcut..... 43**
- Scanning with Start Button..... 47**
- Operations for the scanned image edit window ..... 48**
- Select document settings ..... 51**
- Setting the output ..... 53**
- Scanning Shortcut setting ..... 54**
- About file formats ..... 54**
- Environmental Settings..... 56**

## What is CaptureOnTouch?

CaptureOnTouch is a scanning application that enables you to scan a document with a simple operation merely by selecting the screen panel.

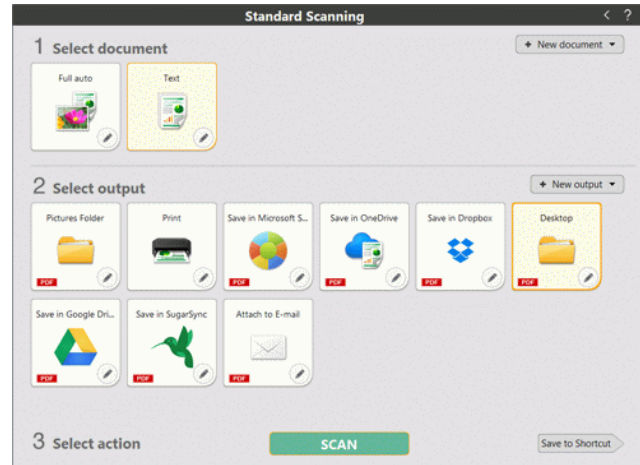

CaptureOnTouch is provided with multiple scanning methods that can be selected according to the purpose and application.

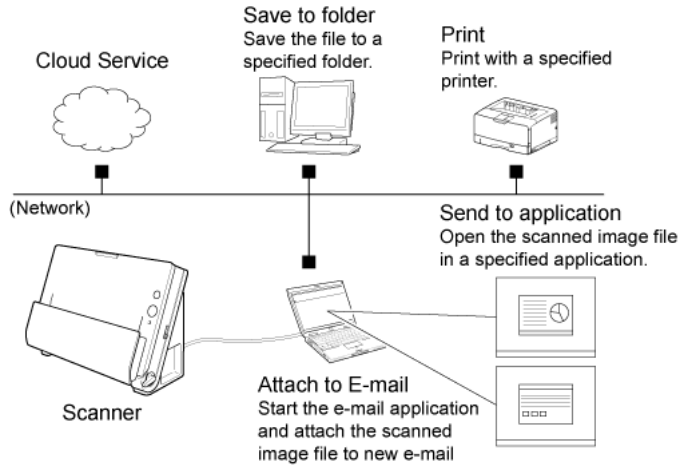

CaptureOnTouch supports the following scanning methods.

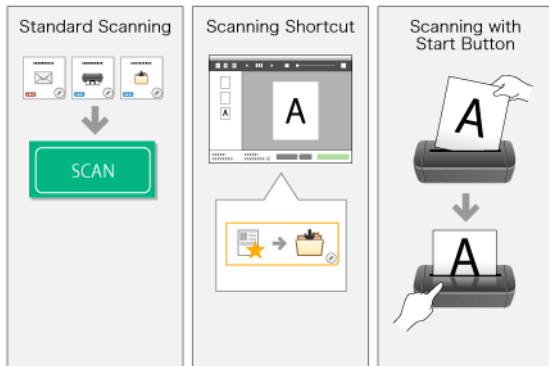

### Standard Scanning

Click the Select document and Output panels, and then click the [Scan] button to scan the document. You can select the scan method according to the document type and purpose of use before scanning.

-> " Standard Scanning"

### Scanning Shortcut

You can register in advance combinations of frequently-used document selections and output methods as a " Scanning Shortcut" . Just click the Scanning shortcut panel to implement the scan.

-> " Scanning Shortcut"

### Start button

" Scanning shortcuts" are allocated to the scanner start button in advance. Set the document and press the Start button to start the scan. You can also allocate your own shortcuts to the start button.

-> " Scanning with Start Button"

## Starting and Exiting CaptureOnTouch

By default, CaptureOnTouch becomes resident in the system when you start your computer.

### Windows



Double-click  (CaptureOnTouch icon) in the taskbar to start CaptureOnTouch and display the main window.

### NOTE

- You can also start CaptureOnTouch from the Start menu. Click [Start] - [All Programs] - [CaptureOnTouch] - [CaptureOnTouch V4].
- The interval between the time you press the Start button on the scanner and the time scanning begins is shortened when the [Make CaptureOnTouch resident] check box is selected in the [Basic settings] tab of the [Environmental settings] dialog box. For details, see "Environmental Settings" on p.56.

### Mac



Click  (CaptureOnTouch icon) in the menu bar and then click [Launch CaptureOnTouch] from the menu which appears to start CaptureOnTouch and display the main window.

### NOTE

- The interval between the time you press the Start button on the scanner and the time scanning begins is shortened when the [Make CaptureOnTouch resident] check box is selected in the [Basic settings] tab of the [Environmental settings] dialog box. For details, see "Environmental Settings" on p.56.

### Exiting CaptureOnTouch

### Windows

To close the CaptureOnTouch window, click  at the top of the window. This closes the window, but CaptureOnTouch will continue to reside in the system.

To quit the CaptureOnTouch application, click  (CaptureOnTouch icon) in the taskbar, and select [Exit] from the menu.

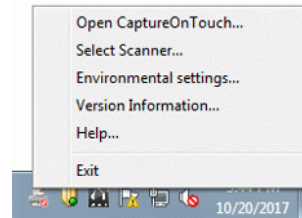

CaptureOnTouch becomes no longer resident in the system and the icon disappears from the taskbar.

## Mac

To close the CaptureOnTouch window, click  at the top of the window. This closes the window, but CaptureOnTouch will continue to reside in the system.

click  (CaptureOnTouch icon) in the menu bar, and select [Exit] from the menu.

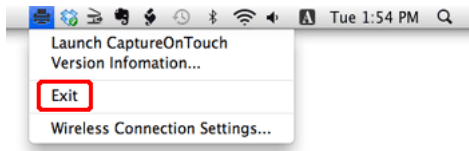

## Restarting CaptureOnTouch

To use CaptureOnTouch after it has been made not resident in the system, use one of the following procedures to restart it. CaptureOnTouch will start and become resident in the system again.

## Windows

- Click [Start] - [All Programs] - [CaptureOnTouch] - [CaptureOnTouch V4].
- Press the Start button on the scanner (in this case, the main screen of CaptureOnTouch will open and scanning will start using the scan method assigned to the Start button).

## NOTE

In Windows 8.1, it is registered in the following location.

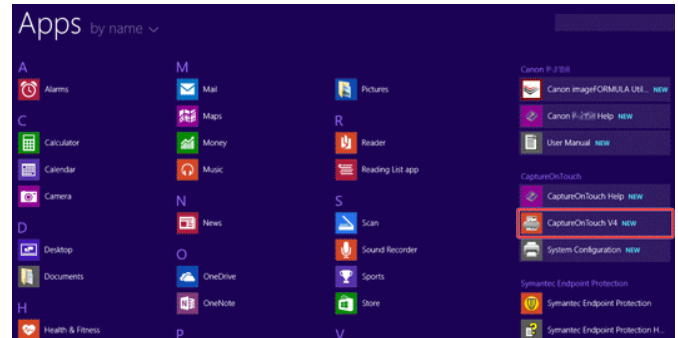

## Mac

- Open [GO] - [Applications] folder from the Finder, and double-click [CaptureOnTouch].
- Press the Start button on the scanner (in this case, the main screen of CaptureOnTouch will open and scanning will start using the scan method assigned to the Start button).

## Selecting a scanner

The following is an explanation of how to select a scanner using CaptureOnTouch.

→ Windows

→ Mac

### Windows

- 1 Click the  (CaptureOnTouch Icon) on the taskbar.



- 2 Click [Select Scanner] on the menu.

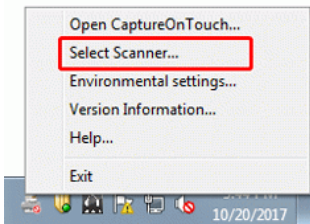

- 3 Select the scanner you are using and click [OK].

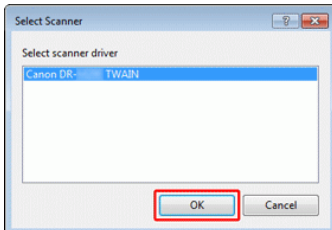

If the scanner you are using does not appear, reinstall the scanner driver.(see P.16)

### Mac

- 1 Click  (CaptureOnTouch Icon) in the menu bar and then click [Select Scanner] from the menu which appears.

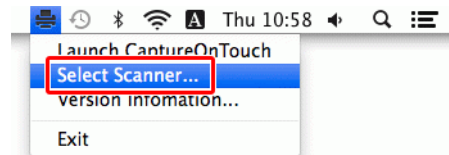

- 2 Select the scanner you are using and click [OK].

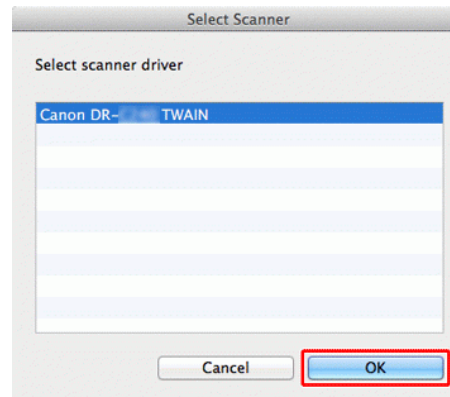



## Screen Descriptions

There are two areas in the CaptureOnTouch main screen, [Scanning Shortcut] and [Standard Scanning].

Use the [>] [<] at the top right of the main window to move between sections.

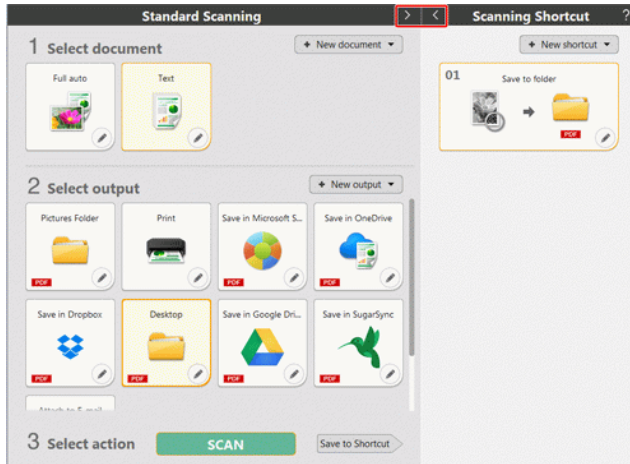

Various panels have been prepared according to the scan types and outputs in each section.

Click the [New document] button, and a [New document] panel will be added.



### NOTE

Click  to open the Help. [Windows](#)

## Standard Scanning

Operations;

Selecting the Select document panel-> Selecting the Select output panel->Start scanning

- 1 Place the document in the scanner.
- 2 Click the select document panel for the document to be scanned from [1 Select document].

The selected [Select document] panel will be displayed in orange. To edit scan images, see "Select document settings".

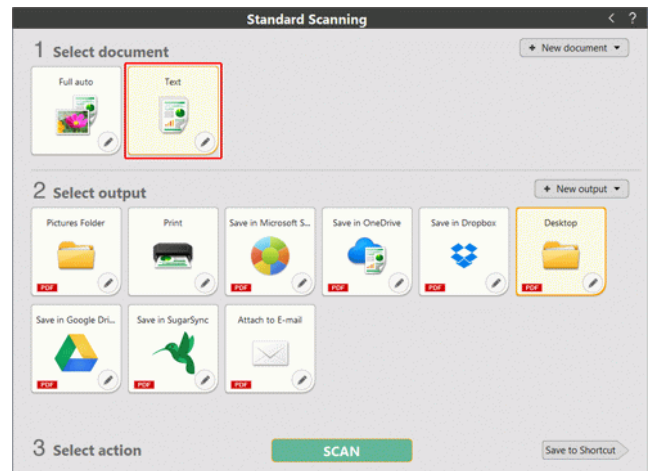

**3 Click the output panel for the scan image application from [2 Select output].**

The selected [Output] panel will be displayed in orange. To edit the [Output] panel, see "Setting the output".

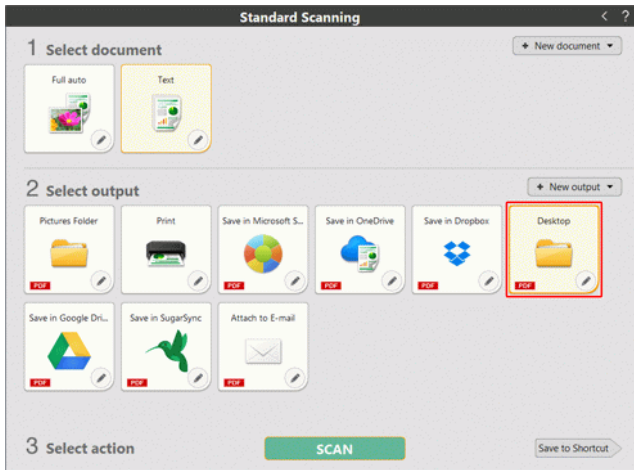

**4 Click the [SCAN] button.**

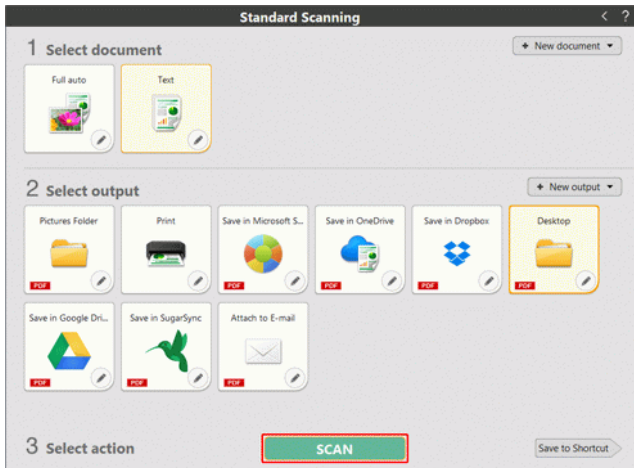

The document is scanned. While scanning is in progress, the number of pages scanned is displayed in addition to the scanner settings.

When the scan is finished, the [Scanned image preview screen] opens.



**NOTE**

If using the same document selection and output combination the next time, click the [Save to Shortcut] button.

The selected [Output] and [Select document] will be added to the [Scanning shortcut] panel.



**CAUTION**

- If you configure scanning conditions that consume a large amount of the computer's memory, scanning may stop because of insufficient memory. If an error message appears due to insufficient memory while scanning is in progress, stop scanning, change the scanning conditions, and then try scanning again.
- A multiple-page scan cannot be saved when it reaches the file size of 2 GB. Change the save settings if an error message is displayed.

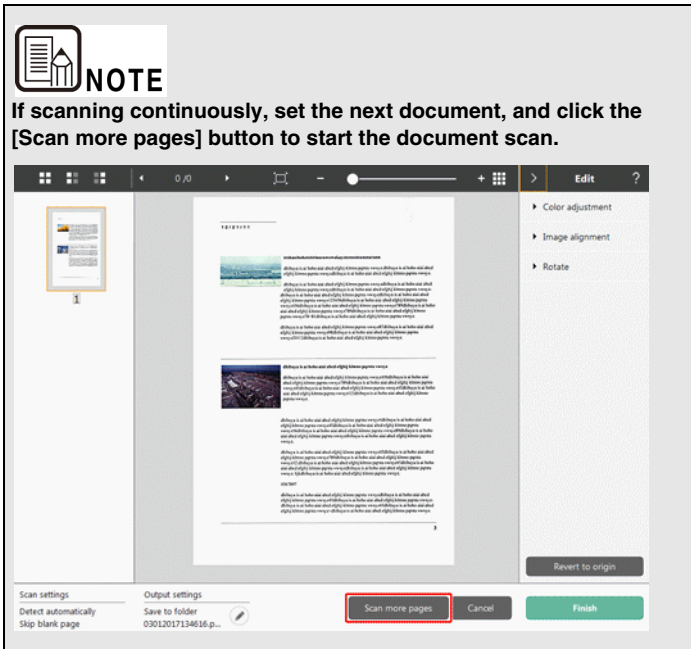

**5 To check the scanned image, click the [Finish] button.**

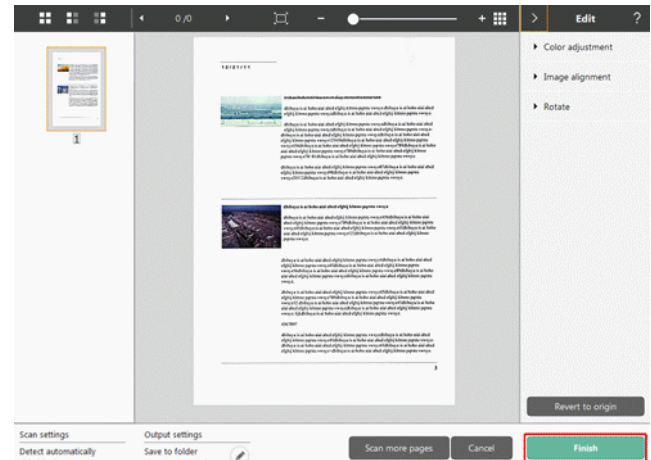

To edit scan images, see "Operations for the scanned image edit window" on p.48.

Click the [  ] button to edit the output settings. -> "Setting the output"

Click the [Cancel] button to discard the scanned image and return to the main window.

When the output has finished, a popup window will be displayed. If saving the scanned image, a link to open the save destination folder will be displayed.

This completes the Standard Scanning.

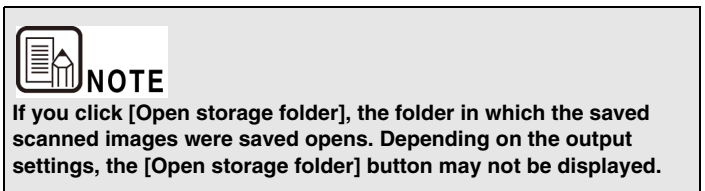
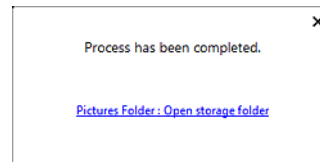

## Scanning Shortcut

### Operations;

Save [Scanning Shortcut] -> Scan the document -> Output the scanned images

By adding scanning shortcuts that combine frequently-used document selections and outputs, you can scan just by clicking the Scanning Shortcut panel.



### NOTE

If a registered scanning shortcut is allocated to the start button, you can implement shortcut scans using these settings just by pressing the scanner start button -> "Scanning with Start Button"

## Registering and editing scanning shortcuts

Multiple scanning shortcuts can be allocated to CaptureOnTouch.

- 1 Either click the [New shortcut] button in [Scanning shortcut], or select the document scan and output in [Standard Scanning], and click the [Save to Shortcut] button.

A scanning shortcut panel will be created.

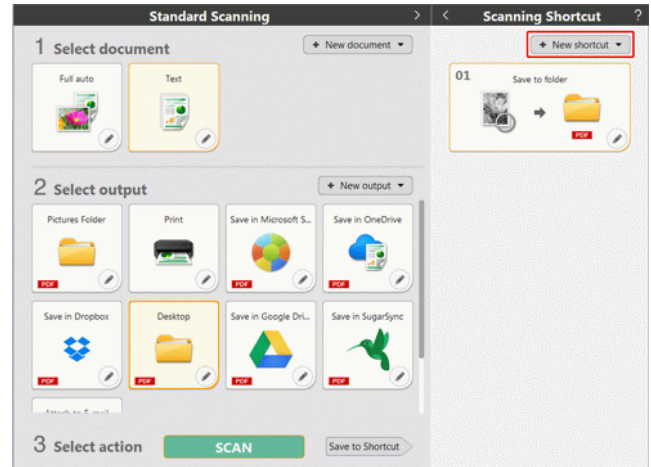

### NOTE

You can also create a new Destination panel by clicking [ - ] on the [New] button, and in the menu that appears, selecting the type of Scanning Shortcut.

2 This screen appears when you click the Edit button on the Scanning Shortcut panel.



3 Click the [Scan] tab to set the document selection. -> "Select document settings"



4 Click the [Output] tab to set the outputs. -> "Setting the output"

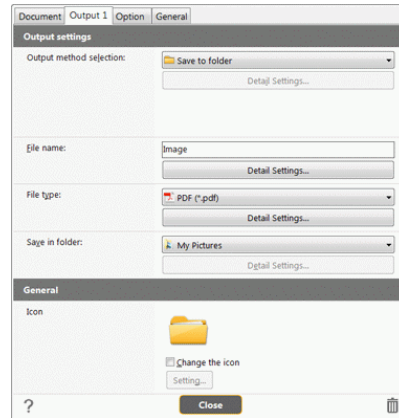

5 Click the [Option] tab to set the options.

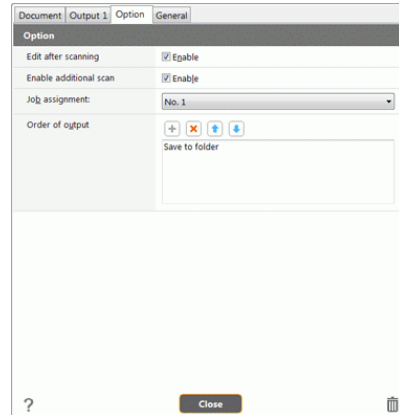

### [Edit after scanning]

Check it on to enable modifying the scanned images in Scan Editing screen. -> "Operations for the scanned image edit window"

### [Enable additional scan]

Check it on to display [Scan more pages] button in the Scan Editing screen to enable continuing scanning.

### [Button assignment]

You can allocate one of the settings registered in scanning shortcuts to the scanner start button.

If a scanning shortcut is allocated to the start button, its icon will be displayed in the scanning shortcuts panel.



### [Order of output]

Click each button to configure "Adding and Deleting output," and "Order change".

### 6 Click the [General] tab to make other settings.



### [Name]

Enter the Scanning shortcut panel name.

### Selecting and scanning shortcuts

- 1 Place the document in the scanner. -> "Chapter 5 Placing Documents"
- 2 Click the scanning shortcut panel.



The document is scanned. While scanning is in progress, the number of pages scanned is displayed in addition to the scanner settings.

When the scan is finished, the [Scanned image preview screen] opens.

### ! CAUTION

- If you configure scanning conditions that consume a large amount of the computer's memory, scanning may stop because of insufficient memory. If an error message appears due to insufficient memory while scanning is in progress, stop scanning, change the scanning conditions, and then try scanning again.
- A multiple-page scan cannot be saved when it reaches the file size of 2 GB. Change the save settings if an error message is displayed.



## NOTE

If scanning continuously, set the next document, and click the [Scan more pages] button to start the document scan.  
If [Enable additional scan] is disabled in the scanning shortcut settings, the [Scan more pages] button will not be displayed.

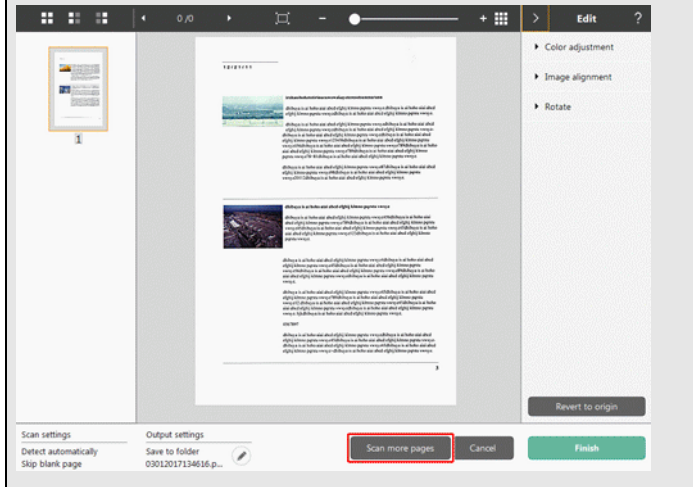

### 3 To check the scanned image, click the [Finish] button.

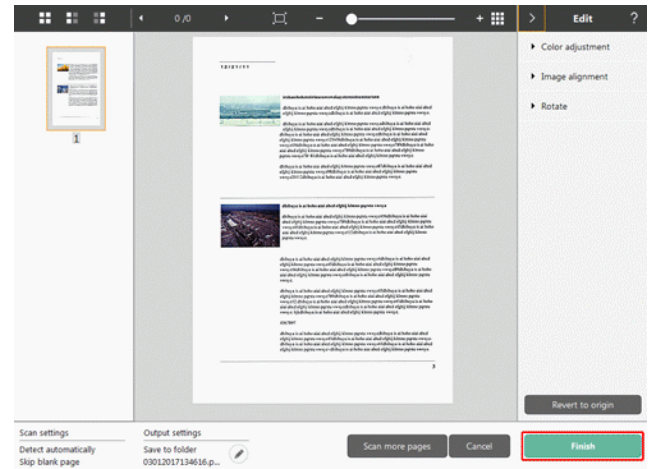

To edit scan images, see "Operations for the scanned image edit window" on p.48.



## NOTE

If [Edit after scanning] is disabled in the scanning shortcut settings, the edit window will not be displayed.

Click the [ ] button to edit the output settings. -> "Setting the output"  
Click the [Cancel] button to discard the scanned image and return to the main window.

When the output has finished, a popup window will be displayed.  
This completes the shortcut scans.

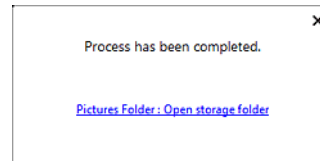



## NOTE

If you click [Open storage folder], the folder in which the saved scanned images were saved opens. Depending on the output settings, the [Open storage folder] button may not be displayed.

## Scanning with Start Button

"Scanning shortcuts" are allocated to the scanner start button in advance.

You can set frequently-used scans to the scanning shortcuts, and then allocate them to the start button.

If you place the document and press the Start button, CaptureOnTouch starts and scanning starts.

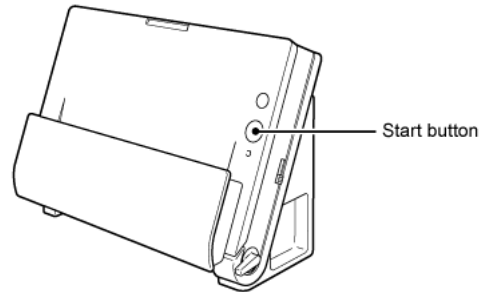

## NOTE

- If the [Do not display the main screen when the scan is started with the scanner button] checkbox is enabled in the global settings, the main CaptureOnTouch window will not be displayed when a scan is started from the start button. Only dialog boxes, error messages, and completion popup windows are displayed during scanning.
- If the [Do not display the main screen when the scan is started with the scanner button] checkbox is enabled, [Enable additional scan] and [edit after scanning] will be disabled when scanning is started from the start button.



## Operations for the scanned image edit window

When scanning has finished, a preview window of the scanned image will be displayed.

To display the edit window in the preview window, click  on the tool bar.





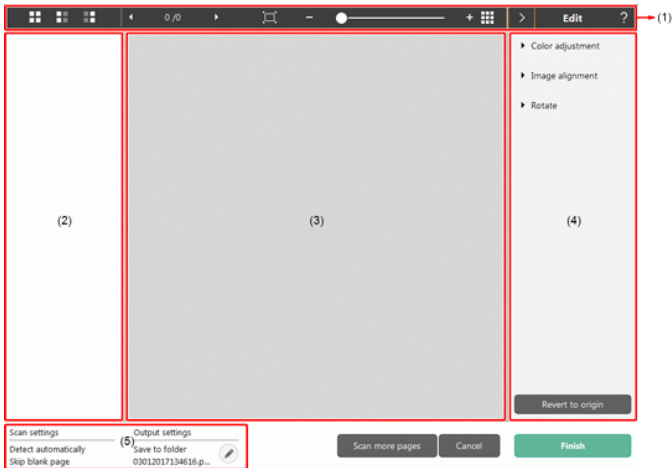







### Scanned image preview screen



#### (1)Toolbar

This tool bar enables operations to thumbnails and preview images.

Tools	Description
	Switches the image selection for the thumbnail area. These buttons mean " All pages ", " Odd pages " and " Even pages " from the left.
	Indicates the page of the image displayed on the preview. Click   to change the page to be displayed.

	Changes the display magnification. Move the slider to + (plus) or - (minus) to enlarge or reduce the preview image. Click  to make the display magnification of the preview enlarged to full-screen.
	Click to display or hide the preview area.
	Click  to display or hide the Edit window.
	Click to display the Help. 

#### (2)Thumbnail Display Area

Thumbnails of the scanned documents will be displayed. You can implement the following operations.

Click a thumbnail to display a preview of the scanned image in the preview window.

Drag a thumbnail to change pages.

#### (3)Preview Area

The preview images of scanned documents are displayed.

#### (4)Edit window

You can edit scanned documents.

Click an item to open the edit window.

Click the [Restore] button to discard the edit results and return to the previous scan image.



### NOTE

If [Edit after scanning] is disabled in the scanning shortcut settings, the edit window will not be displayed.

## [Color adjustment] (Easy settings)

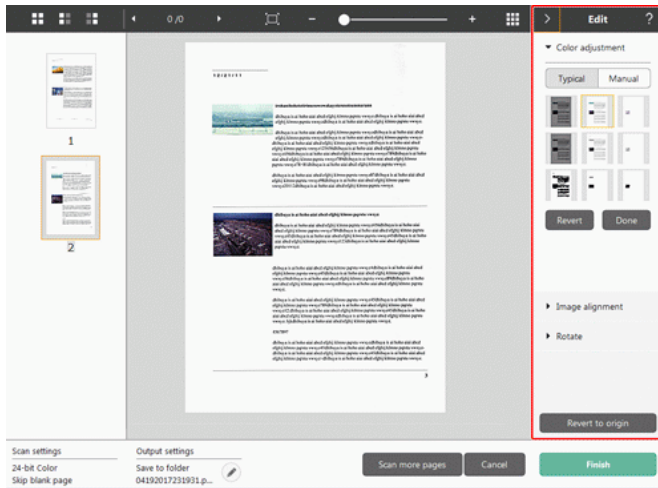

Click [Color adjustment] to display the default.

Click the button to toggle between the typical settings and manual settings displays.

Click a thumbnail in typical color adjustment to select the most suitable preview image that is displayed.

9 thumbnail patterns are displayed for the relevant image in color, and 6 patterns in grayscale.

When adjustment is finished, click the [Done] button. To cancel the adjustment, click the [Revert] button.

## [Color adjustment] (Manual settings)

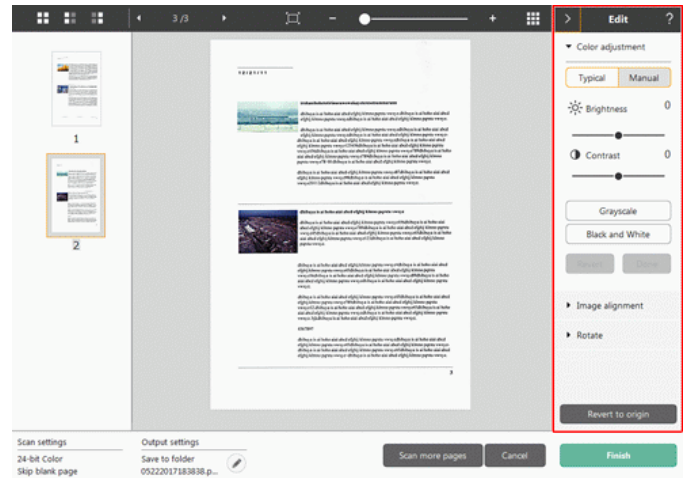

Move the slider to the left or right to adjust the brightness and contrast of the image, checking the preview image.

Click the [Grayscale] button to render the image in grayscale.

Click the [Black and White] button to render the image using 2 values: black and white.

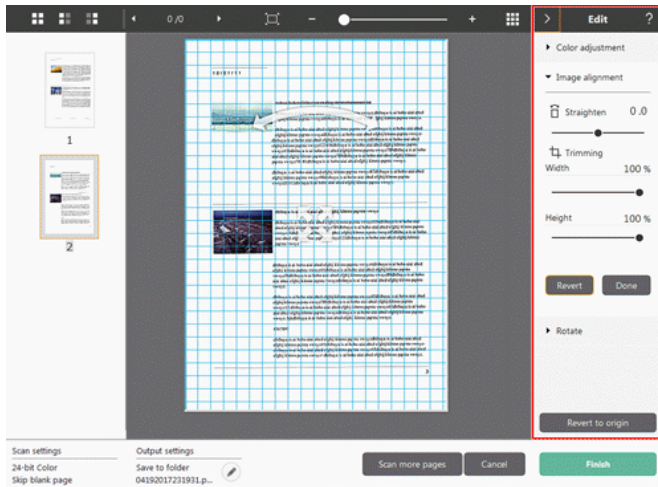

When adjustment is finished, click the [Done] button. To cancel the adjustment, click the [Revert] button.

## [Image alignment]



Click [Image alignment] to display.

The preview image or the slider can be used for the straightening and the trimming.

In the preview image, drag the Move grip , the Straighten grip  and/or the trimming frame directly. To change the extent of the trimmed image, drag the Move grip  on the preview.

When adjustment is finished, click the [Done] button. To cancel the adjustment, click the [Revert] button.

## [Rotate]

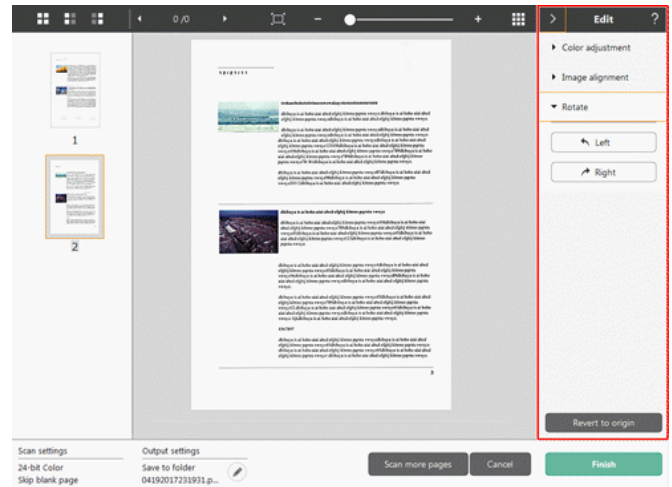

Click [Rotate] to display.

The scanned image can be rotated in 90 degrees to the left or the right. The rotation can be adjusted according to the preview image.

## (5) Information Display Area

The information regarding the "Select document" and "Select output" is displayed.

Click the  button, and the Output Settings dialog will appear.

Click the [Scan more pages] button to continue the scanning.

Clicking the [Cancel] button will destroy the scanned images and return to the top screen.

When clicking the [Finish] button, the output processing will start. After it is completed, the screen will return to the top screen.



**NOTE**  
If [Enable additional scan] is disabled in the scanning shortcut settings, the [Scan more pages] button will not be displayed.

## Select document settings

By default, CaptureOnTouch enables the [Full auto] scan setting, so scanning is implemented using the scan conditions that match the document.

To specify the document size, color mode, and other settings, set the desired scan condition by editing the scan mode panel.

### Creating new [Select document] panels

Click the [New document] button, and a [New document] panel will be added.

Click  to display the list of panel types. The selected type of the panel is created.

### Edit [Select document] panel

The [Select document edit screen] opens when you click the  button in the [Select document] panel.

Click the [Select document] tab in the shortcuts editing window.



### Scan settings

Makes the scan settings.

### [Color mode]

Select the color mode for scanning from below.

Detect automatically	Automatically determines the color mode based on the document content and scans accordingly.
24-bit Color	Scans the document in color.
Grayscale	Scans the document in Grayscale.
Black and White	Scans the document in black and white (binary).

### [Page Size]

Select the paper size of the document to be scanned.

If you specify [Match original size], the page size of the scanned document is detected and the images are saved at the detected size.

### [Dots per inch]

Select the resolution.

Select [Detect automatically] and the software will automatically scan the document at the optimum resolution.

### [Scanning Side]

Select the scanning side of the document.

If you select [Skip blank page], scanned images of blank pages are not saved.

### [Automatically straightens skewed images]

If a document is not straight when fed, the scanner detects that the document is not straight from the scanned image and straightens the skewed image.

Select the setting from below.

Straightens with angle of fed documents, Straightens with angle contents of fed documents

### [Rotate image to match orientation of text]

Check [Enable] on to rotate the image in the same direction with the characters.

## [Use advanced settings dialog box]

Document scan settings include basic items that are configured in [Scan settings], and the settings that are configured in the advanced settings dialog box. The settings in the advanced settings dialog box are applied for settings other than the basic items.

Enable [Use advanced settings dialog box] to implement advanced scanner settings other than the basic items using the advanced settings dialog box (scanner driver). To open the scanner driver, enable this item, and then click the [Settings] button.

Enable [Change icon] to enable the [Settings] button and select the file. The file formats that can be selected as icon files are described below.



- .ico, .exe, .jpg, .png



- .icns, .app, .jpg, .png



### NOTE

The driver settings dialog box includes setting items that are the same as the basic items in [Scanner setting], but the setting for each of them is stored separately.

Which settings are used during scanning differs as follows depending on the setting of the [Use advanced settings dialog box] check box.

Setting of [Use advanced settings dialog box]	Basic items	Other than basic items
OFF	Settings of [Scanner setting]	Settings of the advanced settings dialog box of the scanner driver
ON	Settings of the advanced settings dialog box of the scanner driver	

For the advanced settings other than the basic items, see the help in the driver settings dialog box.

## General

Set the following items as occasion demands.

### Name

Enter the name to be displayed in the select document panel.

### Icon

You can change the document scan icon displayed in the select document panel and scanning shortcut panel.

## Setting the output

By default, CaptureOnTouch enables the settings to convert the scanned images to PDF file and save to a folder.

To specify the output method and save location, edit the output panel and set the desired output.

### Create new [Output] panel

Click the [New output] button to add a [New output] panel.

Click  to display the list of panel types. The selected type of the panel is created.

### Edit [Output] panel

The Edit output screen opens when you click the  button in the Output panel.

Click the [Output] tab in the shortcuts editing window.

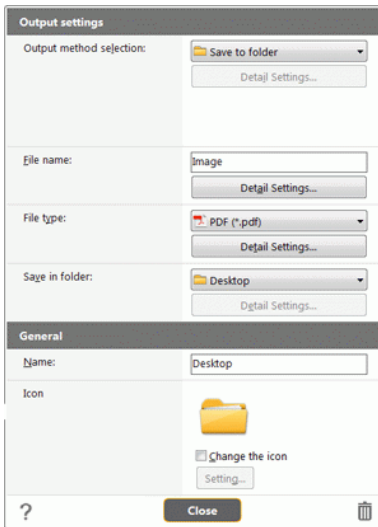

### Select output method

File formats and save locations that can be selected depend on the output method selected.

## Save to folder

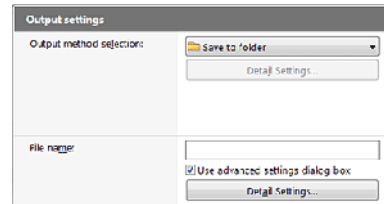

Saves the scanned image to the specified folder. When this output method is specified, set the save location folder.

## Other output methods

CaptureOnTouch supplies output methods other than [Save to folder] as plugins.

By installing the plug-in, you can use various services such as printing the scanned image or attaching it in an e-mail.

To install plugins, enable the checkbox when installing CaptureOnTouch.

The output methods that can be selected depend on the plugins that have been installed.

For how to use the plugins, see the plugin help.

## Scanning Shortcut setting

---

By default, CaptureOnTouch enables the [Full auto] scan setting, so scanning is implemented using the scan conditions that match the document.

To specify combinations of document selection and outputs, you can edit the scanning shortcut panel to set the desired scanning shortcut.

### Creating new [Scanning Shortcut] panels

There are two ways as described below to create a new Scanning Shortcut panel.

- Click the [Save to Shortcut] button in [3 actions] in Standard Scanning to register the selected output and document scan to one of the scanning shortcut panels.
- Click the [New shortcut] button to add [New scanning shortcut] panel. Click  to display the list of panel types. The selected type of the panel is created.

### Editing new [Scanning Shortcut] panels

When the Edit button  is clicked, the Scanning Shortcut panel editing dialog will appear.

The following tabs are on the Edit Scanning Shortcut panel screen.

- [SCAN] Tab
- [Select output] Tab
- [Option] Tab
- [General] Tab

## About file formats





---

Set the file format of the scanned image. When you select a file format other than BMP or PNG, the [Detail Settings] button is enabled, allowing you to make the detail settings for the selected file format.

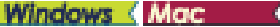
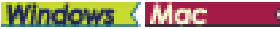

### NOTE

You can select one of the following file formats for the scanned image.

- PDF format 
- TIFF format 
- PNG format 
- JPEG format 
- BMP format 
- PPTX format (File format for Microsoft PowerPoint 2007 and later) 

The file formats that can be selected vary depending on the destination setting.

When you output the scanned image using the plug-in, the image is output in the file format set in the application of the plug-in. Therefore this file format may be different from the one selected in the Select document panel.

## PDF setting

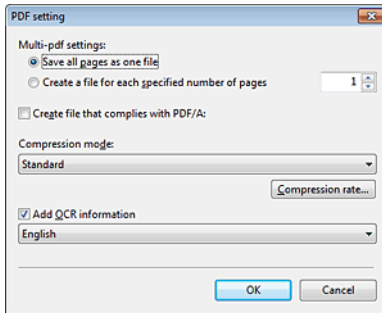

In [Multi-pdf settings], specify whether to save the scanned images as a multi-page file ([Save all pages as one file]) or single page files ([Create a file for each specified number of pages]).

For [Create file that complies with PDF/A], select [ON].

For [Compression mode] select either [Standard] or [high compression].

If you click the [Compression rate] button, you can specify the compression rate in the dialog box that appears.

## TIFF setting

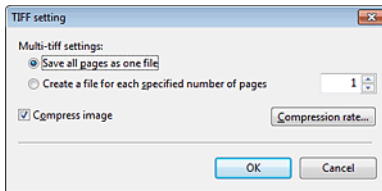

In [Multi-tiff settings], specify whether to save the scanned images as a multi-page file ([Save all pages as one file]) or single page files ([Create a file for each specified number of pages]).

**Windows** By selecting ON for [Compress image] and clicking the [Settings] button, you can specify the compression rate in the dialog box that appears.

## JPEG setting

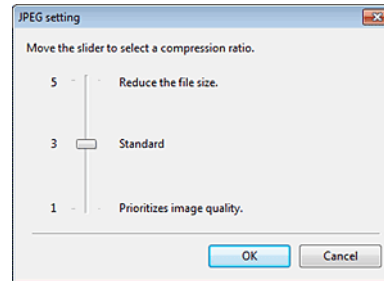

You can specify the compression rate of JPEG images.



## PPTX settings

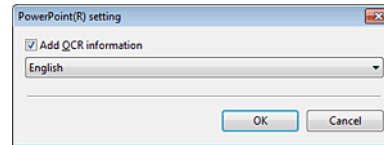

You can specify whether to add OCR information to the scanned images.



## Environmental Settings

To configure the environmental settings of CaptureOnTouch, open the [Environmental settings] dialog box.

### Windows

Click  (CaptureOnTouch icon) in the taskbar, and select [Environmental settings] from the menu.

The following describes the setting items of each tab displayed in the [Environmental settings] dialog box.

### [Basic settings] Tab

On the [Basic settings] tab, configure the following settings.

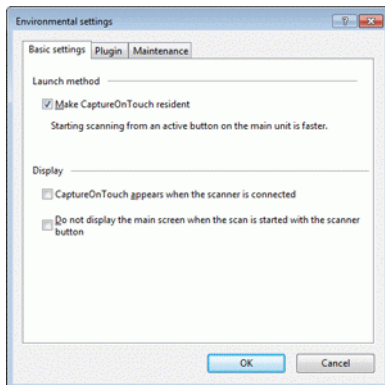

### Launch method setting

By default, CaptureOnTouch becomes resident in the system when you start your computer. Clear the [Make CaptureOnTouch resident] check box to not make CaptureOnTouch resident in the system.

### Display

Select the [CaptureOnTouch appears when the scanner is connected] checkbox to open the main screen of CaptureOnTouch automatically when the scanner is connected to the computer. This setting is only enabled when CaptureOnTouch is running (or resident in the system).

When this setting is enabled, the [Do not display the main screen when the scan is started with the scanner button] setting is disabled.

If the [Do not display the main screen when the scan is started with the scanner button] check box is selected, the main screen of CaptureOnTouch is not displayed when the Scanning Shortcut scanning is started by pressing the scanner's Start button. However, dialogs and error messages during scanning and the pop-up screen when the scan is completed will be displayed.

When this setting is enabled, the [Enable additional scan] and [Edit after scanning] check boxes on the Edit Scanning Shortcut settings screen are disabled.

### [Plugin] Tab

On the [Plugin] tab, confirm the plugins that have been added to CaptureOnTouch.

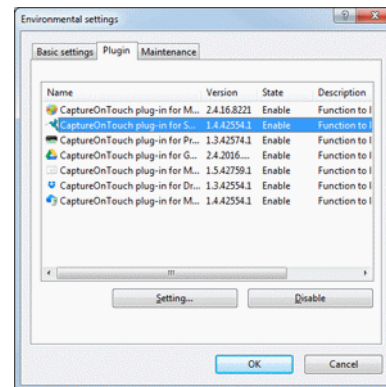

### [Setting] button

Displays the detailed information on the selected plugins.



### NOTE

This button may not be displayed for some plugins.

## [Enable] [Disable] button

This button is used to toggle between Enable/Disable modes for the plugin selected from the plugin list.

If you click the [Disable] button, the following dialog is displayed.

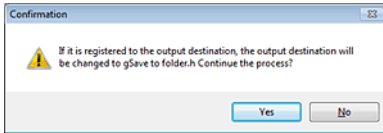

## [Maintenance] Tab

On the [Maintenance] tab, you can configure the log settings for the maintenance of CaptureOnTouch and initialize the settings.

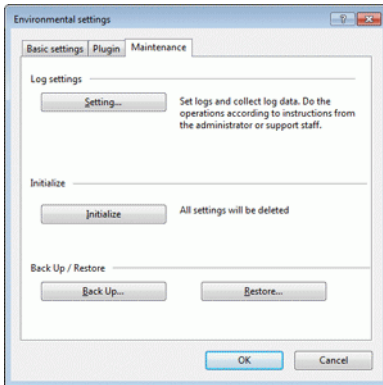

## Back Up / Restore

Use the [Back Up] and [Restore] buttons to back up the configuration file (settings, registered jobs, etc.) of CaptureOnTouch and restore the settings from the backup data.

## [Back Up] button

Back up the settings of CaptureOnTouch to a backup file (\*.cot). You can store the initial settings of CaptureOnTouch by performing a backup before you first use CaptureOnTouch.

## [Restore] button

Restore the settings from the backup file.

When using multiple computers, you can back up the environmental settings of one computer and then perform a restore on the other computers so that all of the computers have the same settings.

## Log settings

The Log file settings screen opens when you click the [Settings] button. Select the type of log file.

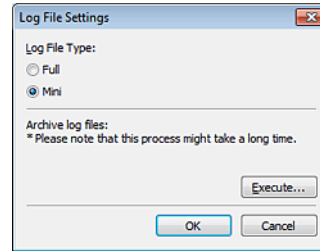

If you click the [Execute] button, the [Save File] dialog is displayed.

## [Initialize]

A confirmation dialog box appears when you click the [Initialize] button.

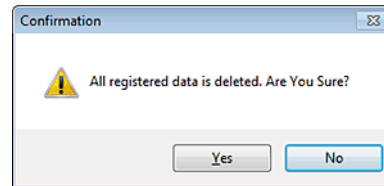

All CaptureOnTouch data are deleted and returned to the default settings.



Click [Preferences] from the [CaptureOnTouch DR-C225] menu while the main screen of CaptureOnTouch is displayed.

The following describes the setting items of each tab displayed in the [Environmental Settings] dialog box.

## [Basic settings] Tab

On the [Basic settings] tab, configure the following settings.

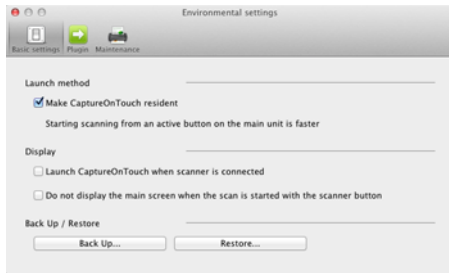

### Launch method setting

By default, CaptureOnTouch becomes resident in the system when you start your computer. Clear the [Make CaptureOnTouch resident] check box to not make CaptureOnTouch resident in the system.

### Display setting for when scanner connected

Select the [Launch CaptureOnTouch when scanner is connected] checkbox to open the main screen of CaptureOnTouch automatically when the scanner is connected to the computer. This setting is only enabled when CaptureOnTouch is running (or resident in the system).

### Back Up / Restore

Use the [Back Up] and [Restore] buttons to back up the configuration file (settings, registered jobs, etc.) of CaptureOnTouch and restore the settings from the backup data.

### [Back Up] button

Back up the settings of CaptureOnTouch to a backup file (\*.plist). You can store the initial settings of CaptureOnTouch by performing a backup before you first use CaptureOnTouch.

### [Restore] button

Restore the settings from the backup file.

When using multiple computers, you can back up the environmental settings of one computer and then perform a restore on the other computers so that all of the computers have the same settings.

## [Plugin] Tab

On the [Plugin] tab, confirm the plugins that have been added to CaptureOnTouch.

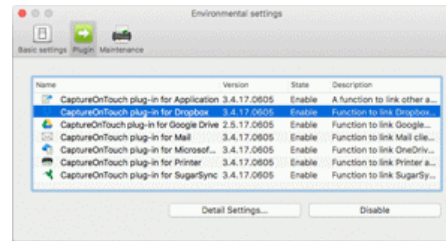

### [Detail Settings] button

Displays the detailed information on the selected plugins.



### NOTE

This button may not be displayed for some plugins.

### [Enable] [Disable] button

This button is used to toggle between Enable/Disable modes for the plugin selected from the plugin list.

### Deleting plugins

Click the [Delete] button to delete a plugin selected in the list.

## [Maintenance] Tab

On the [Maintenance] tab, configure the following settings.

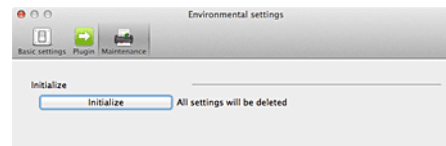

### [Initialize]

Return all settings to their default condition.

# Chapter 7 Setting the Scanner Driver

When you load the driver for the first time, the selected scanner and a dialog for selecting the default paper size are displayed. 



### NOTE

- These settings will apply when [Default] is clicked in the ISIS driver dialog box.
- For the TWAIN driver, the default size will be set to A4 and this cannot be modified.

When you scan a document in an ISIS compatible or TWAIN compatible application (CaptureOnTouch, etc.), open the scanner driver and configure the scanning conditions and other settings.

This section describes the configuration and functions of the scanner driver.

- Configuration and Functions of the Scanner Driver ..... 59
- Setting Basic Scanning Conditions ..... 62
- Function Restrictions Depending on Mode Setting ..... 65

## Configuration and Functions of the Scanner Driver



The scanner driver has the following tabs.



### NOTE

For details on the setting screen, see the Help of the scanner driver. Click the [Help] button of the driver to display help related to the corresponding tab or dialog box.

### [Basic] Tab

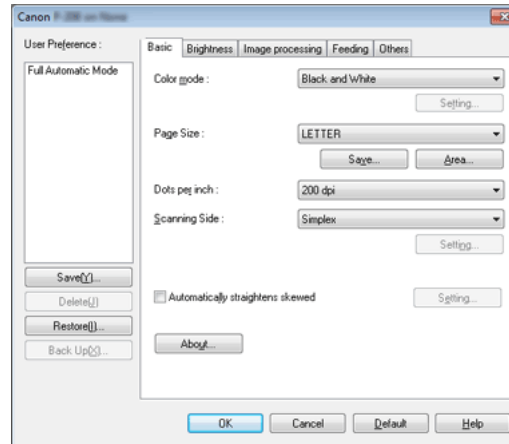

Configure basic scanning conditions such as the mode, page size, resolution, and scanning side.

In addition, you can click the [Area] button and specify the area to be scanned.



## NOTE

Depending on the ISIS compatible application, the application may have its own screen for setting scanning conditions. If the scanner driver is opened in such an application, setting items related to the functions provided by the scanner driver other than scanning conditions will be displayed on the [Basic] tab.

## [Brightness] Tab

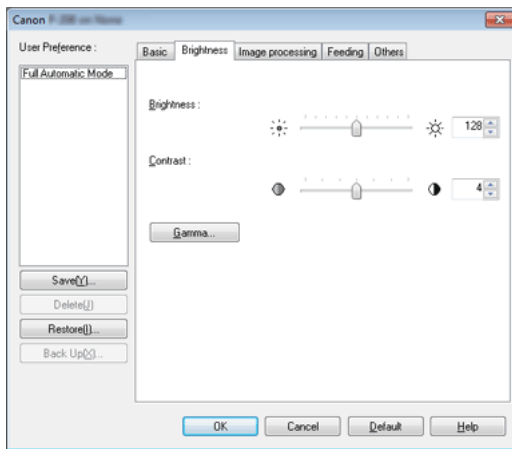

Adjust the brightness and contrast of scanned images.

In addition, you can also click [Gamma] and set the gamma correction value for scanned images.



## NOTE

- Gamma correction is set when the color tone of the scanned image is different from that of the image displayed on the monitor.
- For information on your monitor's gamma value, see the instruction manual that came with the monitor.

## [Image processing] Tab

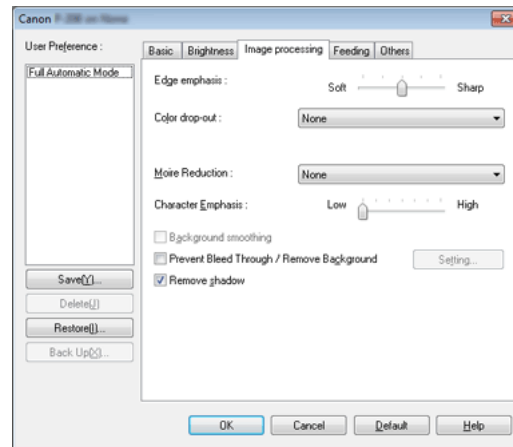

Set the processing method for scanned images.

## [Feeding] Tab

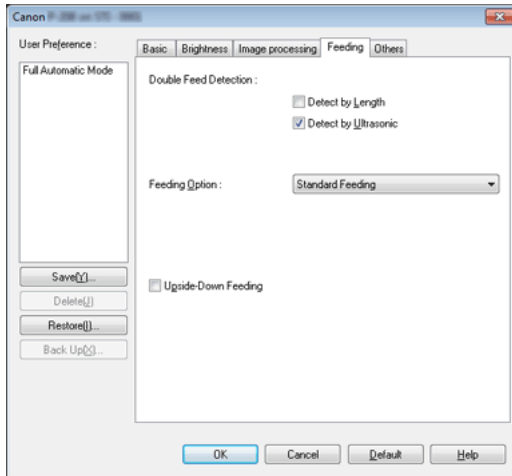

Specify scanner operations related to document feeding.

## [Others] Tab

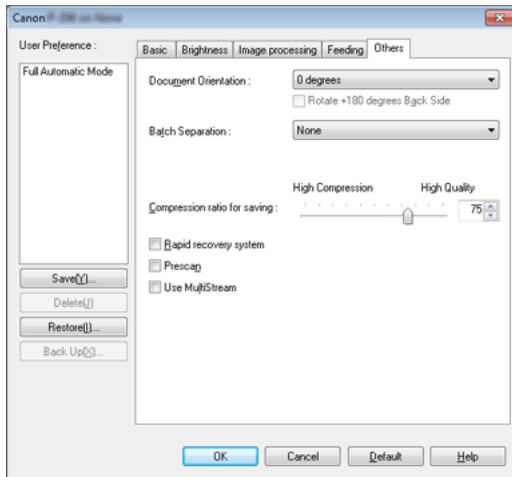

Configure settings for specialized scanning and image processing.



When the scanner driver is opened from CaptureOnTouch, the following settings screen of the scanner driver appears.





## NOTE

When you access the settings screen of the scanner driver from a TWAIN compatible application, you can switch the settings screen between Simple Mode and Advanced Mode screens shown below.

### Simple Mode

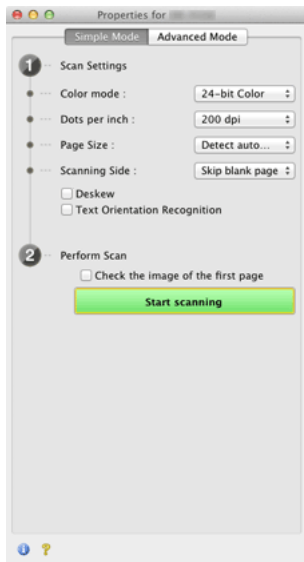

### Advanced Mode



## Setting Basic Scanning Conditions

This section provides an overview of the basic setting items that are the minimum requirements when configuring the scanner settings.



### Confirming Basic Conditions for Scanning

When you scan a document, make sure you confirm the [Color mode], [Page Size], [Dots per inch], and [Scanning Side] basic conditions in the Basic settings dialog box.

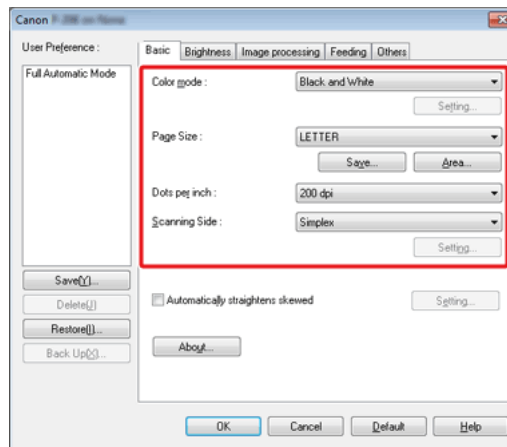

## Color mode

Select the scanning mode.

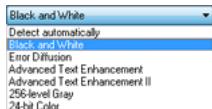

- [Advanced Text Enhancement] and [Advanced Text Enhancement II] remove or process the background color and background surrounding text to enhance the text for easy reading. When [Advanced Text Enhancement II] is selected, you can make the text in scanned images easier to read by adjusting the contrast on the [Brightness] tab.
- [Detect automatically] detects whether the document is in color, grayscale, or black and white. You can configure advanced settings related to the detection method by clicking [Setting]. For details, see the Help.

## Page Size

Select the page size that matches the document to be scanned.



If [Match original size] is selected, the edges of the document are detected and images that match the size of the document are saved.

## Dots per inch

Select the scanning resolution.

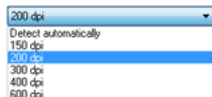

Higher resolutions provide clearer images but result in larger file sizes and slower scanning.

When [Detect automatically] is specified, the resolution is detected automatically from the content printed in the document.

## Scanning Side

Select which of the sides of the document to scan.

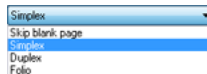

If the scanning side is set to [Skip blank page], the images of blank pages are deleted when images are saved.



## Confirming Basic Conditions for Scanning

When you scan a document, make sure you confirm the [Color mode], [Dots per inch], [Page Size], and [Scanning Side] basic conditions in the settings screen of the scanner driver.

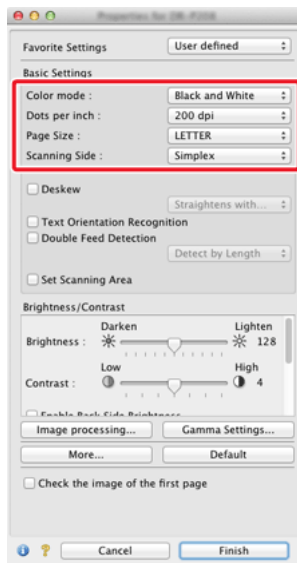



## Color mode

Select the scanning mode.

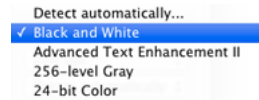

- [Advanced Text Enhancement II] removes or processes the background color and background surrounding text to enhance the text for easy reading.
- [Detect automatically] detects whether a document is color, grayscale, or black and white based on its content. When this is selected, you can configure detailed settings for the detection method. Refer to the Help for details.

## Dots per inch

Select the scanning resolution.

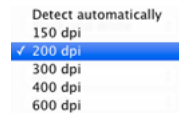

- Higher resolutions provide clearer images but result in larger file sizes and slower scanning.
- When [Detect automatically] is specified, the resolution is detected automatically from the content printed in the document.

## Page Size

Select the page size that matches the document to be scanned.

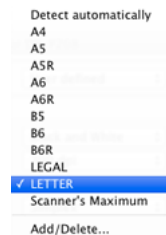

If [Detect automatically] is selected, the edges of the document are detected and images that match the size of the document are saved.

## Scanning Side

Select which of the sides of the document to scan.

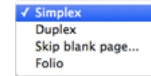

If the scanning side is set to [Skip blank page], the images of blank pages are deleted when images are saved.

## Function Restrictions Depending on Mode Setting

→ Windows

→ Mac

Windows

Some of the setting items in each of the driver tabs are disabled as follows depending on the setting for [Color Mode] on the [Basic] tab.

### [Brightness] tab

Setting value	Contrast
Detect automatically	○
Black and White	○
Error Diffusion	○
Advanced Text Enhancement	-
Advanced Text Enhancement II	○
256-level Gray	○
24-bit Color	○

○: Available for setting -: Not available for setting

### [Others] Tab

Setting value	Prescan
Detect automatically	-
Black and White	○
Error Diffusion	○
Advanced Text Enhancement	○
Advanced Text Enhancement II	○
256-level Gray	○
24-bit Color	○

○: Available for setting -: Not available for setting

### [Image processing] tab

Setting value	Edge emphasis	Color drop-out	Background smoothing
Detect automatically	○	-	○
Black and White	○	○	-
Error Diffusion	○	○	-
Advanced Text Enhancement	○	○	-
Advanced Text Enhancement II	-	○	-
256-level Gray	○	○	○
24-bit Color	○	-	○

Setting value	Prevent Bleed Through / Remove Background	Character Emphasis
Detect automatically	○*1	○*2
Black and White	○	○
Error Diffusion	○	○
Advanced Text Enhancement	-	○
Advanced Text Enhancement II	-	○
256-level Gray	○	-
24-bit Color	○	-

O: Available for setting -: Not available for setting

\*1Not available for setting if all of the following conditions in the [Auto Image Type Detection Settings] dialog box are met.

- [Detection Mode] is not set to [Color or Gray]
- [Mode in case of binary] in the [Settings for in case of binary] tab is set to [Advanced Text Enhancement] or [Advanced Text Enhancement II]

\*2Not available for setting when [Detection Mode] is set to [Color or Gray] in the [Auto Image Type Detection Settings] dialog box.



Some of the setting items are disabled as follows depending on the setting for [Color Mode] in the settings screen of the scanner driver.

### Simple Mode

Setting value	Check the image of the first page
Detect automatically	-
Black and White	O
Error Diffusion	O
Advanced Text Enhancement II	O
256-level Gray	O
24-bit Color	O

O: Available for setting -: Not available for setting

### Advanced Mode

Setting value	Enable Back Side Brightness	Enable Back Side Contrast
Detect automatically	O	O
Black and White	O	O
Error Diffusion	O	O
Advanced Text Enhancement II	-	-
256-level Gray	O	O
24-bit Color	O	O

O: Available for setting -: Not available for setting

### [Image processing] dialog box

Setting value	Edge emphasis	Background smoothing	Prevent Bleed Through / Remove Background
Detect automatically	O	O*	-
Black and White	O	-	O
Error Diffusion	O	-	O
Advanced Text Enhancement II	-	-	-
256-level Gray	O	O	O
24-bit Color	O	O	O

Setting value	Color drop-out	Character Emphasis
Detect automatically	-	-
Black and White	O	O
Error Diffusion	O	O
Advanced Text Enhancement II	O	O
256-level Gray	O	-
24-bit Color	-	-

O: Available for setting -: Not available for setting

\* Only when [Detection mode] is set to [Color or Gray] in the settings screen that appears after [Detect automatically] is selected.

# Chapter 8 Special Scanning

This section provides examples of scanning settings for different purposes. For details on setting options, see " Chapter 7 Setting the Scanner Driver" on p.59

## Practical Examples

- To scan unregistered size documents ..... 67
- When you want to specify the scan area..... 68
- When you want to delete the images of the blank pages in two-sided documents..... 69
- When you do not want to scan colored lines and text ..... 70
- When you want to enhance the color red..... 71
- When you want to enhance contours in images ..... 72
- When you want to make lines or characters in the scanned images thicker ..... 73
- When you want to enhance text that is difficult to read because of factors such as the background of the scanned document..... 74
- When you want to detect multiple pages fed at the same time..... 75
- When you want to scan a document placed upside-down ..... 76
- When you want to match the orientation of images to the text when scanning a mixture of pages with different text orientations..... 77
- When you want to rotate the images of a document placed horizontally to correct the orientation..... 78
- When you want to set the scanner conditions automatically ..... 79
- When you want to use batch separation for scanning ..... 80
- When you want to use multistream settings for scanning ..... 81
- When you want to save a scanner driver setting ..... 83
- Scan Panel..... 84

## To scan unregistered size documents

### Windows

Configuring the following settings allows you to scan a document of an unregistered page size.

You can register a non-standard page size that has not been registered as a page size by naming and registering it as a custom page size in the [Custom Page Size] dialog box, which is opened from the [Save] button on the [Basic] tab.

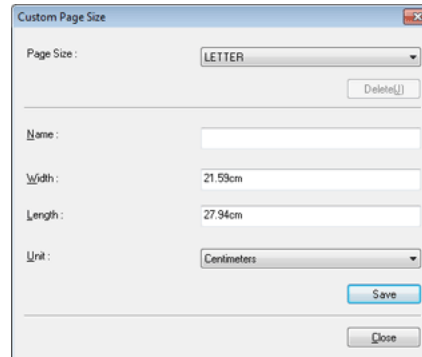

## Mac

Configuring the following settings allows you to scan a document of an unregistered page size.

When scanning a document of a non-standard page size, select [Add/Delete] for [Page Size] to display the [Add/Delete Page Size] dialog box. Name and register the unregistered page size in [Page Size].

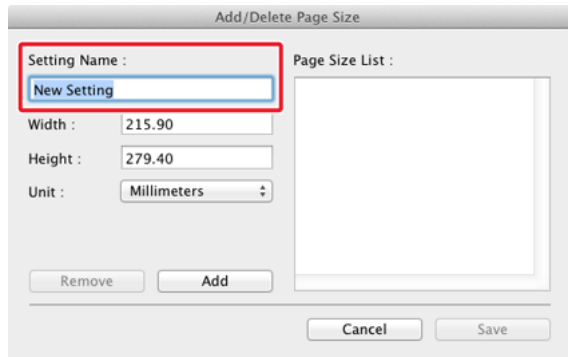

## When you want to specify the scan area

### Windows

Specify the area of the document to be scanned in the [Scan Area] dialog box, which is opened from the [Area] button on the [Basic] tab.

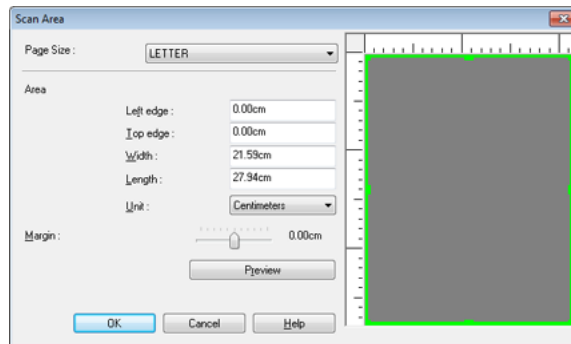

## Mac

Select the [Set Scanning Area] check box and then specify the area of the document to be scanned.

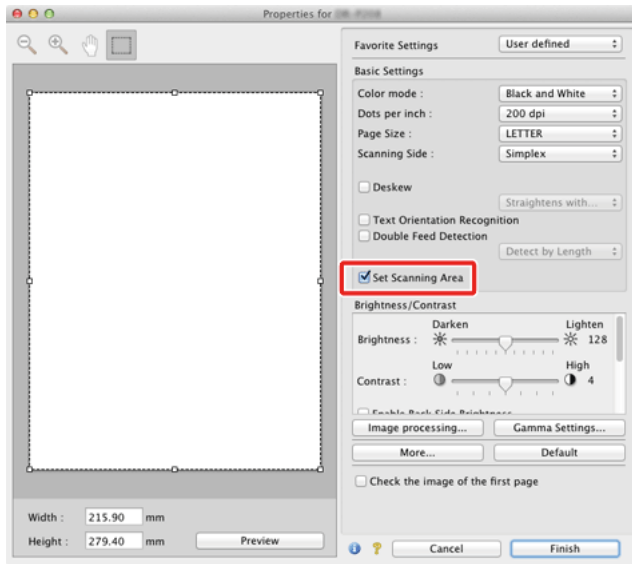

Also, if you scan the document when [Check the image of the first page] is selected, only one page of the document is scanned and the corresponding scanned image is displayed in the preview window.

## When you want to delete the images of the blank pages in two-sided documents

## Windows

Set the scanning side setting to [Skip Blank Page] on the [Basic] tab to delete the images of the blank pages in the document.

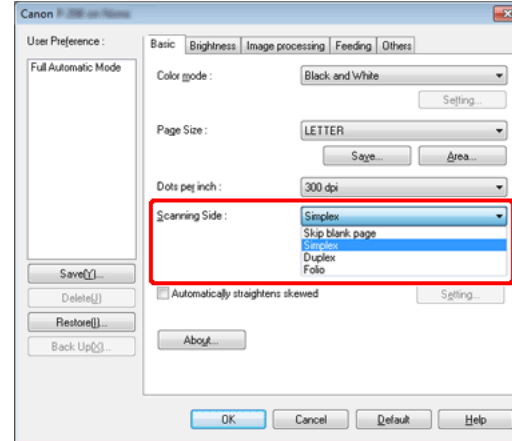

If [Skip Blank Page] is selected, the [Setting] button is enabled, and you can adjust the level for judging whether pages are blank.

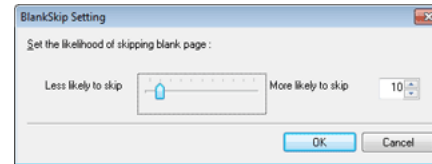

## Mac

Set the scanning side setting to [Skip blank page] to delete the images of the blank pages in the document.



If [Skip blank page] is selected, you can adjust the level for judging whether pages are blank.

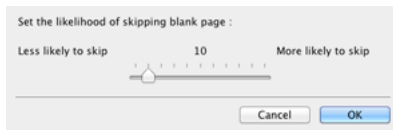

## When you do not want to scan colored lines and text

### Windows

Specify the color (red, blue, or green) to be ignored (dropped out) in the color drop-out settings on the [Image processing] tab, and that color will not be scanned.

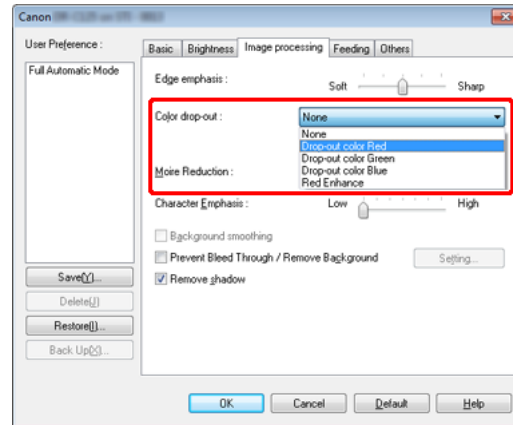

## Mac

Click [Image processing] and specify the color (red, blue, or green) to be ignored (dropped out) in the dialog box that appears, and that color will not be scanned.

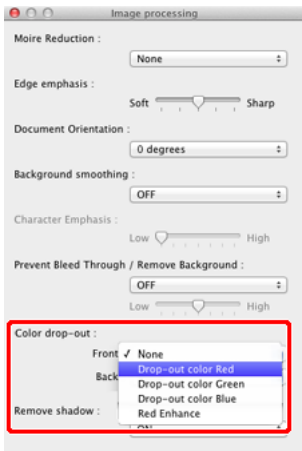

## When you want to enhance the color red

## Windows

Specify [Red Enhance] for [Color drop-out] on the [Image processing] tab to enhance the color red in the document.

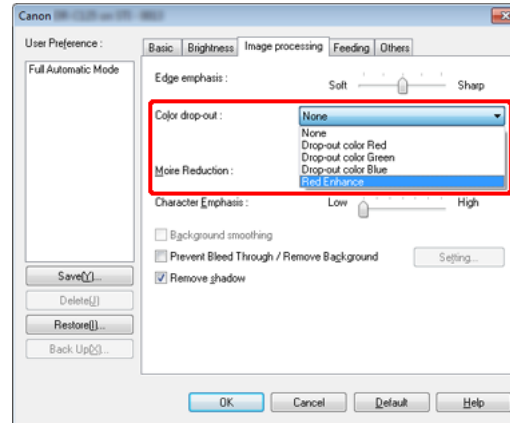





Click [Image processing] and specify [Red Enhance] for [Color drop-out] in the dialog box that appears to enhance the color red in the document.

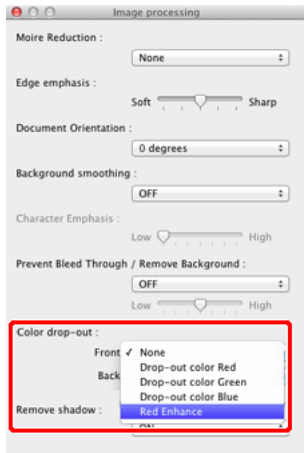

## When you want to enhance contours in images



Adjust the edge emphasis setting on the [Image processing] tab.

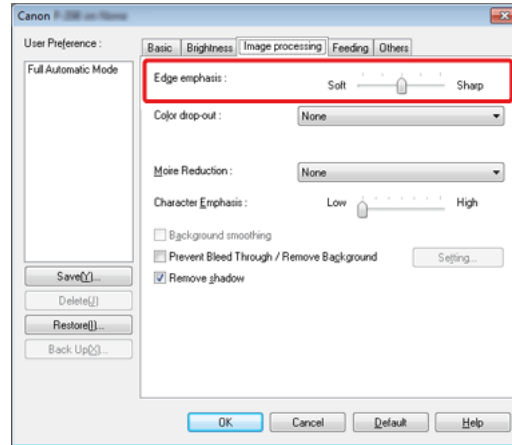

## Mac

Click [Image processing] and adjust the edge emphasis settings in the dialog box which appears.

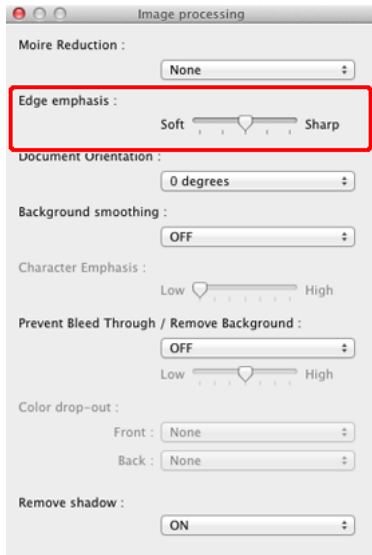

## When you want to make lines or characters in the scanned images thicker

## Windows

Drag the slider for [Character Emphasis] on the [Image processing] tab to make the lines and characters that appear in the scanned image thicker.

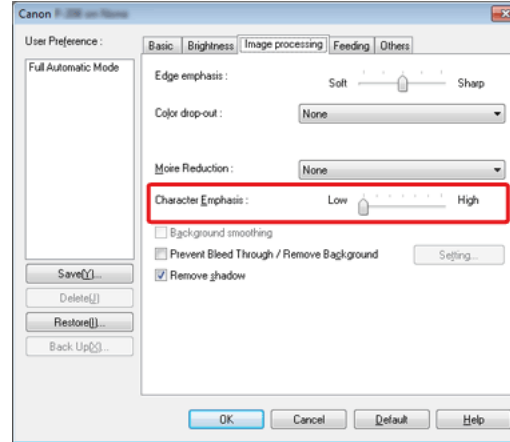

## Mac

Click [Image processing], and in the dialog box that appears adjust letter and line thickness settings.



## When you want to enhance text that is difficult to read because of factors such as the background of the scanned document

### Windows

Select [Advanced Text Enhancement] or [Advanced Text Enhancement II] in the mode setting on the [Basic] tab. The background behind the text is removed or processed so that the text is emphasized for better readability.

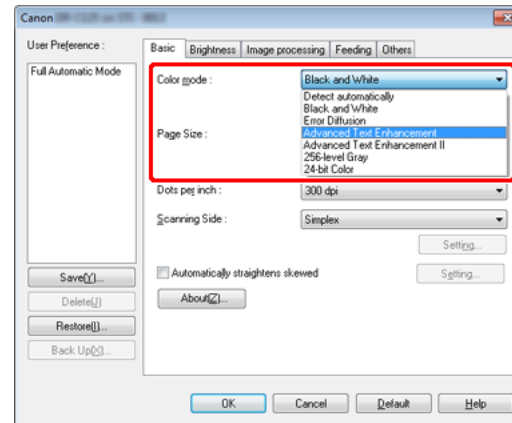

- Advanced Text Enhancement is suitable for a document with a light background color or a document with a non-uniform background (such as a pattern). If the background is uniform, it is removed where it surrounds the text, and if the background is non-uniform, it is processed to enhance text readability.
- Advanced Text Enhancement II is suitable for scanning a document with a uniform background color and light text and background. If the background is non-uniform, such as a pattern, the background may not be able to be completely removed and the text may become difficult to read. If necessary, you can make the text in scanned images easier to read by adjusting the contrast on the [Brightness] tab.

## Mac

Select [Advanced Text Enhancement II] in the [Color mode] setting. The background behind the text is removed or processed so that the text is emphasized for better readability.

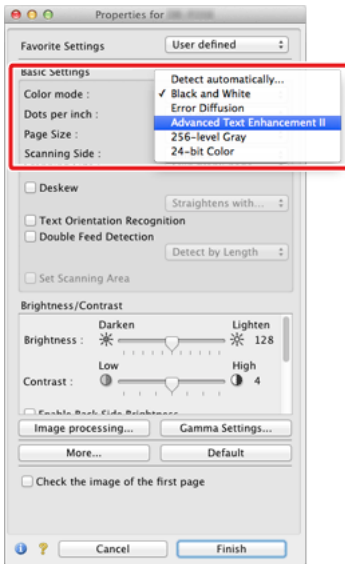

## When you want to detect multiple pages fed at the same time

### Windows

Select the [Double Feed Detection] check box on the [Feeding] tab. You can enable either one or both of [Detect by Ultrasonic] and [Detect by Length].

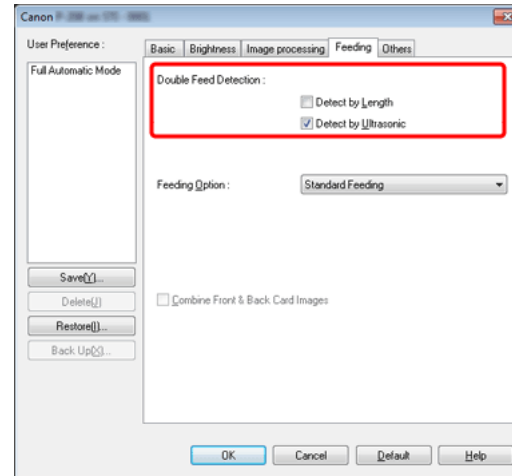

## Mac

Select the [Double Feed Detection] check box, and then select any one of [Detect by Ultrasonic], [Detect by Length], and [Detect by Ultrasonic and Length].

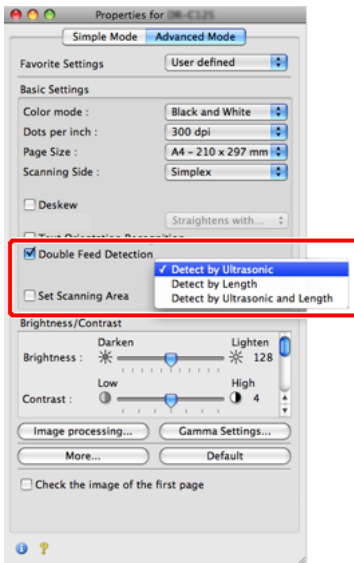

## When you want to scan a document placed upside-down

### Windows

Select the [Upside-down feeding] check box on the [Feeding] tab if you want to insert documents into the scanner upside-down (i.e., with the top edge of the document facing down).

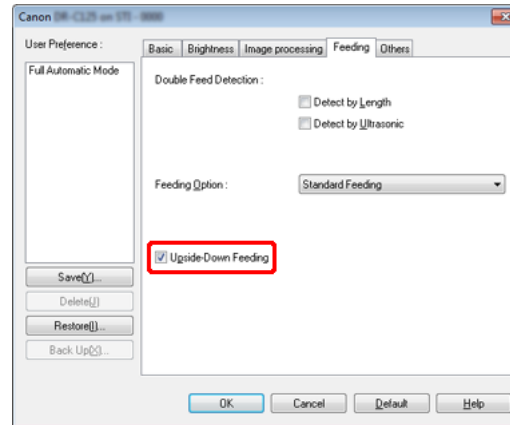

### NOTE

Even if [Detect by Ultrasonic] or [Detect by Ultrasonic and Length] is selected, a double feed may not be detected if the document is small.

## Mac

Select the [Upside-down feeding] check box in the dialog box that appears when you click [More] if you want to insert documents into the scanner upside-down (i.e., with the top edge of the document facing down).

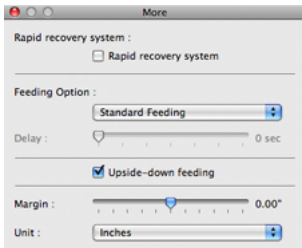

## When you want to match the orientation of images to the text when scanning a mixture of pages with different text orientations

## Windows

Select [Text orientation recognition] in [Document Orientation] on the [Others] tab. The text orientation on each page is detected, and the scanned image is rotated in 90-degree increments to correct the orientation.

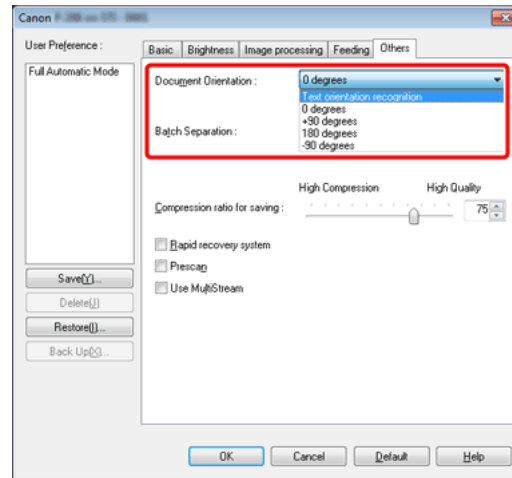

## Mac

Select the [Text Orientation Recognition] check box. The text orientation on each page is detected, and the scanned image is rotated in 90-degree increments to correct the orientation.

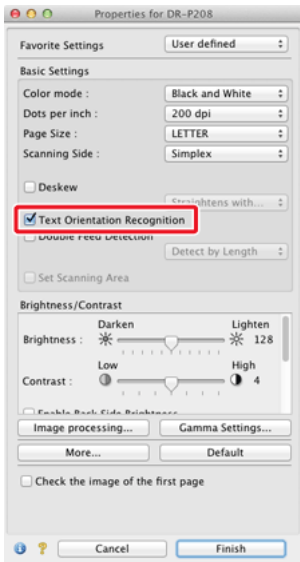

## When you want to rotate the images of a document placed horizontally to correct the orientation

## Windows

Specify the rotation angle in [Document Orientation] on the [Others] tab.

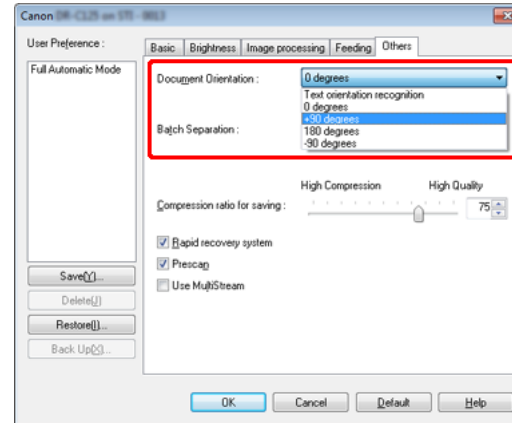

### NOTE

When the [Text Orientation Recognition] check box is selected, [Document Orientation] is unavailable.

## Mac

Click [Image processing] and specify the rotation angle in [Document Orientation] in the dialog box that appears.

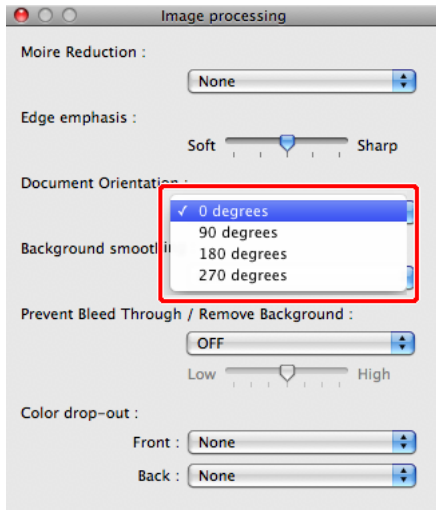

## When you want to set the scanner conditions automatically

### Windows

Set [Full Automatic Mode] in [User Preference] to scan with scanning conditions that match the document.

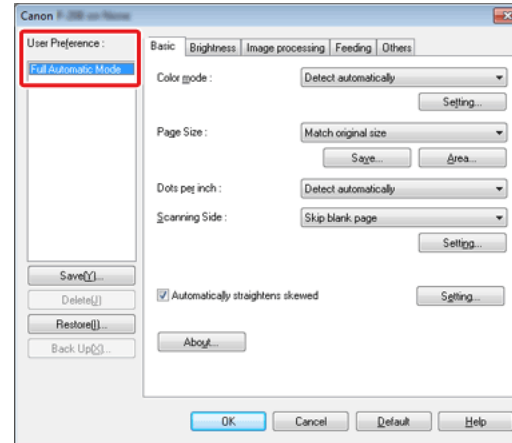



## Mac

Set [Full Automatic Mode] in [Favorite Settings] to scan with scanning conditions that match the document.

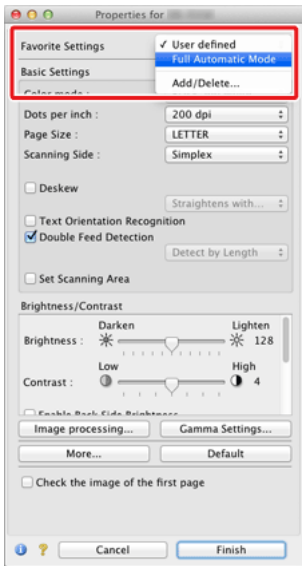

## When you want to use batch separation for scanning

### Windows

When you want to divide and scan a document, you can separate a batch at the timing with which each next document is placed and scanned. In this case, set the scanner driver as follows.

- Set [Feeding Option] on the [Feeding] tab to [Panel-Feeding] or [Automatic Feeding].

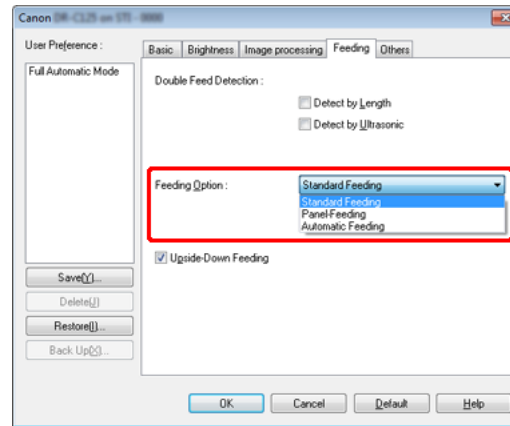

### NOTE

When [Full Automatic Mode] is selected, [Color mode], [Page Size], and [Dots per inch] are all detected automatically. In addition, the [Scanning Side] setting becomes [Skip blank page] and [Document Orientation] becomes [Text orientation recognition].

- Set [Batch Separation] on the [Others] tab to [Auto] or [Panel].

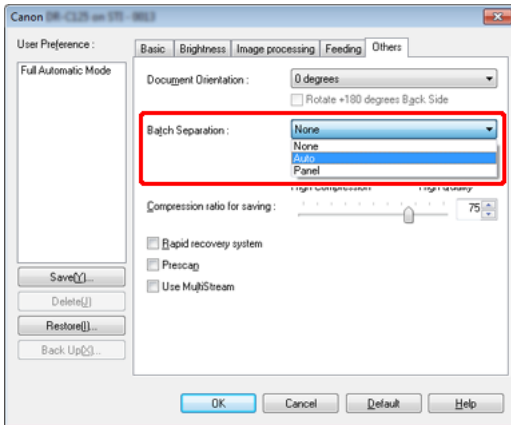

When [Batch Separation] is set to [Auto], the batch is separated after the next document is placed and scanning is continued. When [Panel] is set, the batch is separated after the [Batch Separation] check box of "Scan Panel" on p.84 is selected and then scanning is continued.



## NOTE

This function is only enabled for applications that support batch separation.

## When you want to use multistream settings for scanning

### Windows

Multistream settings allow you to output multiple different scanned images with a single scan operation, and output scanned images with different scanning conditions for each of the front and back pages.



## IMPORTANT

- The multistream settings can only be used in Windows.
- Depending on the application program, these settings may not appear.

When you want to use the multistream settings for scanning, select the [Use MultiStream] checkbox on the [Others] tab to display the setting items related to multistream, and then configure the setting items in the following order.

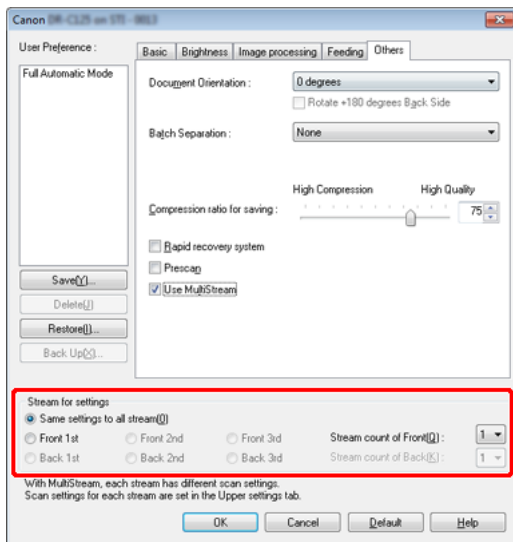

- (1) When you want to specify different scanning conditions for the front and back pages of a document, select [Skip Blank Page] or [Both] for [Scanning Side] on the [Basic] tab in advance.
- (2) Specify the number of scanning conditions to apply in [Stream count of Front]. Up to three can be specified.
- (3) Select [Front 1st], and then open the other tabs and set the scanning conditions. Depending on the value specified for [Stream count of Front], configure the remaining [Front 2nd] and [Front 3rd] in the same way.
- (4) When specifying the scanning conditions of the back, configure the settings in the same way as described in (1) to (3). In this case, specify [Stream count of Back], and then set the scanning conditions for each of [Back 1st] to [Back 3rd].



**NOTE**  
The following shows the setting conditions that can be set in the multistream settings.

Tab	Items that can be set
[Basic] tab	[Color mode] and [Dots per inch] (excluding [Detect automatically] for both)
[Brightness] tab	[Brightness] and [Contrast]
[Image processing] tab	[Edge emphasis], [Color drop-out] and [Character Emphasis]
[Feeding] tab	None (all disabled)
[Others] tab	None (only [Use MultiStream] is enabled)

## When you want to save a scanner driver setting

### Windows

When you finish configuring a setting, click the [Save] button of [User Preference] to save the setting.

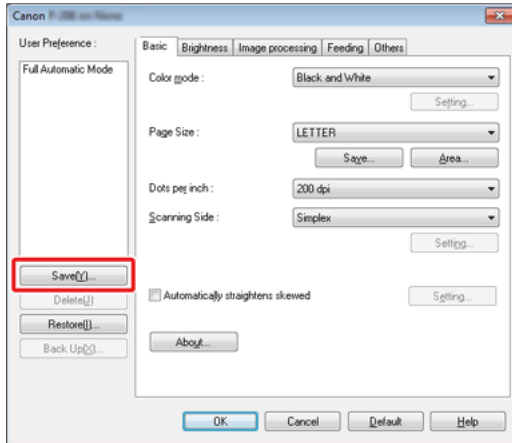

The saved setting is registered to the list. You can delete a setting from the list with the [Delete] button, and save or load a configuration file with the [Back Up] or [Restore] button.

### Mac

When you finish configuring a setting, select [Add/Delete] of [Favorite Settings] to save the setting.

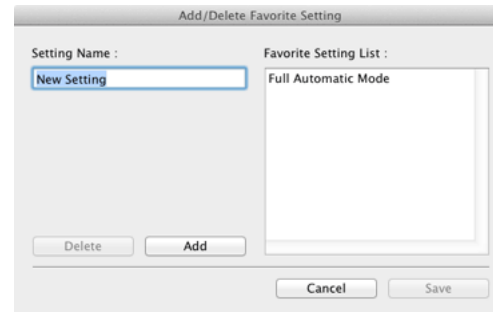

Clicking the [Add] button registers the current setting to [Favorite Setting List]. Use the [Delete] button to delete a setting from the list.



### NOTE

The preregistered [Full Automatic Mode] cannot be deleted from [Favorite Setting List].



### NOTE

The preregistered [Full Automatic Mode] cannot be deleted from [User Preference].

## Scan Panel

Scan Panel is software for controlling scanning operations such as feeding documents and stopping scanning when scanning multiple documents one after the other.

### Windows

Scan Panel runs when [Feeding Option] is set to [Panel-Feeding] or [Automatic Feeding] in the settings dialog box of the scanner driver. In this case, the Scan Panel appears when you are not scanning and the scanner enters the wait state.

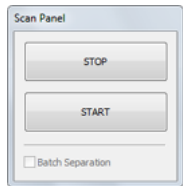

If you place the next document and then click the [START] button in Scan Panel, scanning of the placed document starts.

You can stop scanning part way through by clicking the [STOP] button of Scan Panel.

### Mac

If you click [More] in the settings screen of the scanner driver and then set [Feeding Option] to [Panel-Feeding] or [Automatic Feeding] in the dialog box which appears, Scan Panel appears when the scanner starts.

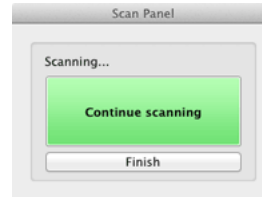

When scanning of the first document finishes, Scan Panel appears and the scanner enters the wait state. If you place the next document and then click [Continue scanning], scanning of the placed document starts.

You can stop scanning part way through by clicking [Finish].



### NOTE

When [Batch Separation] on the [Others] tab is set to [Panel], you can separate the batch by selecting [Batch Separation] in Scan Panel and then clicking [START].

## Chapter 9 Regular Maintenance

Clean the scanner and perform maintenance on a regular basis as described below to maintain peak scanning quality.

<b>Cleaning the Scanner</b> .....	<b>85</b>
<b>Cleaning the Scanning Glass and the Rollers</b> .....	<b>86</b>
<b>Adjusting the Reduction Ratio</b> .....	<b>89</b>

### CAUTION

- When cleaning the scanner and the inside of the scanner, turn the power OFF and disconnect the power cord from the power outlet.
- Do not use spray cleaners to clean the scanner. Precision mechanisms, such as the light source, may get wet, and cause a malfunction.
- Never use paint thinner, alcohol, or other organic solvents to clean the scanner. Such solvents can damage or discolor the exterior of the scanner, or create a risk of fire or electrical shock.

## Cleaning the Scanner

---

---

To clean the exterior of the scanner, dampen a cloth with water or a mild detergent, wring the cloth out thoroughly, and then wipe the dirt away. Then use a dry, soft cloth to wipe away any moisture.

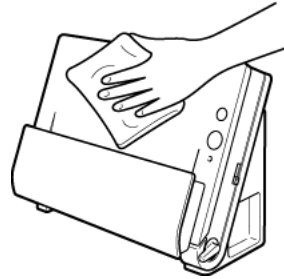

### Cleaning the Inside of the Scanner

Dust or paper particles inside the scanner may cause lines or smudges to appear on scanned images. Use compressed air to periodically clean dust and paper particles from the document feed opening and the inside of the scanner. After finishing a large scanning job, turn OFF the scanner and then clean out any paper particles remaining inside the scanner.

## Cleaning the Scanning Glass and the Rollers

If scanned images contain streaks, or if the scanned documents become dirty, the scanning glass or rollers inside the scanner may be dirty. Clean them periodically.

- 1 Open the document feed tray. Press the OPEN button and pull open the front unit toward you.

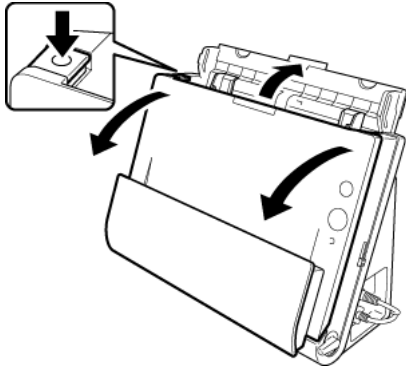

- 2 Use compressed air to remove dust and paper particles from the inside of the scanner.

- 3 Clean the scanning glass.

Wipe the scanning glass with a cloth that has been dampened with water and thoroughly wrung out, and then use a dry, soft cloth to wipe away any moisture.

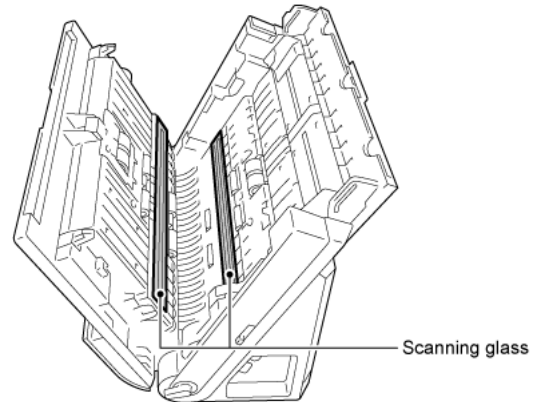

### CAUTION

Do not spray water or neutral detergent directly on the scanner. Precision mechanisms, such as the light source, may get wet, and cause a malfunction.

### IMPORTANT

Scratches on the scanning glass may cause marks on the images, as well as feeding errors. If there are scratches on the scanning glass, contact your local authorized Canon dealer or service representative.

**4 Clean the rollers.**

Wipe the rollers with a cloth that has been dampened with water and thoroughly wrung out, and then use a dry, soft cloth to wipe away any moisture.

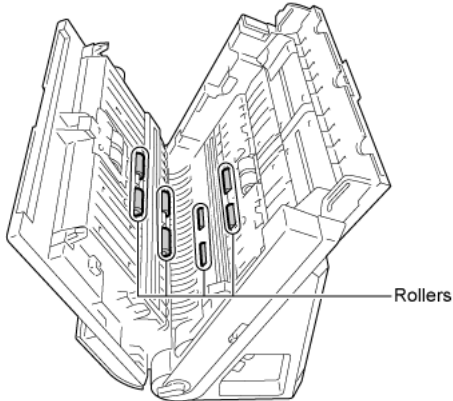

**5 Remove the retard roller and feed roller. (See "Replacing the Feed Roller" on p.94 , "Replacing the Retard Roller" on p.95)**

 **IMPORTANT**

Remove the retard roller and feed roller from the scanner to clean them, and make sure to reattach them to the scanner when cleaning is finished.

**6 Wipe the removed rollers with a cloth that has been dampened with water and thoroughly wrung out.**

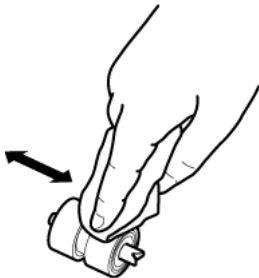

**7 Reattach the retard roller and feed roller. (See "Replacing the Feed Roller" on p.94 , "Replacing the Retard Roller" on p.95)**

**8 Close the front unit by gently pushing it up on both sides until it clicks into place. Make sure that the front unit is completely closed by pushing until you hear a click.**

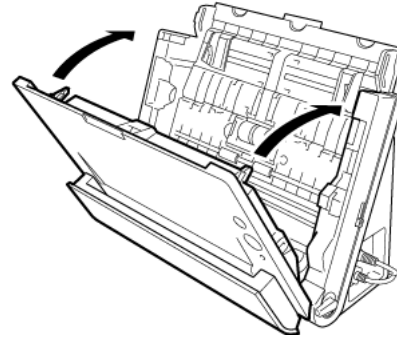

**9 Close the document feed tray.**

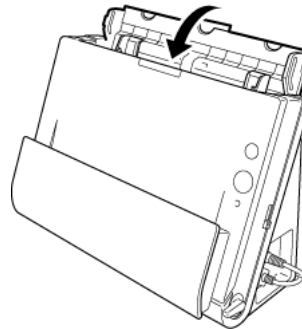



**10 Open the document eject pocket.**

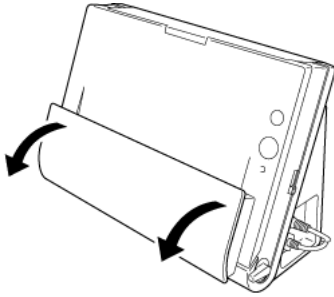

**12 Close the document eject pocket.**

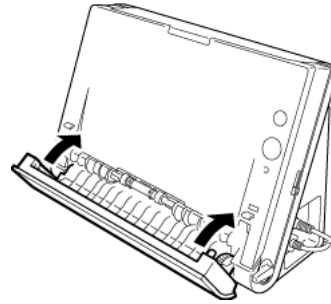

**11 Clean the rollers inside the document eject pocket.**

Wipe the rollers with a cloth that has been dampened with water and thoroughly wrung out, and then use a dry, soft cloth to wipe away any moisture.

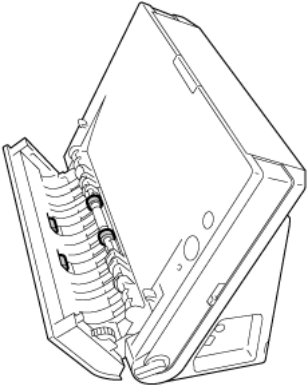

## Adjusting the Reduction Ratio

As the rollers installed in the scanner wear out, scanned images may become stretched in the vertical direction. If this happens, you can reduce the amount of stretching of the image by adjusting the reduction ratio.

### Windows

- 1 Start Windows and log in as a user with administrator privileges.
- 2 Click the Start button, and then click [All Programs], [Canon DR-C225], and [Canon imageFORMULA Utility].  
imageFORMULA Utility starts.

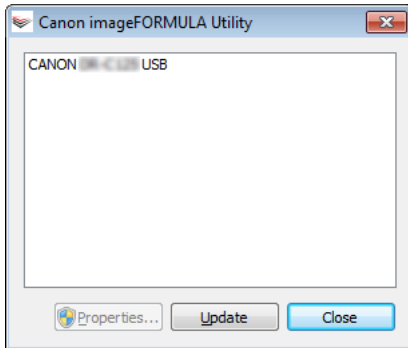

- 3 Click [CANON DR-C225 USB] and click [Properties].  
Scanner properties are displayed.

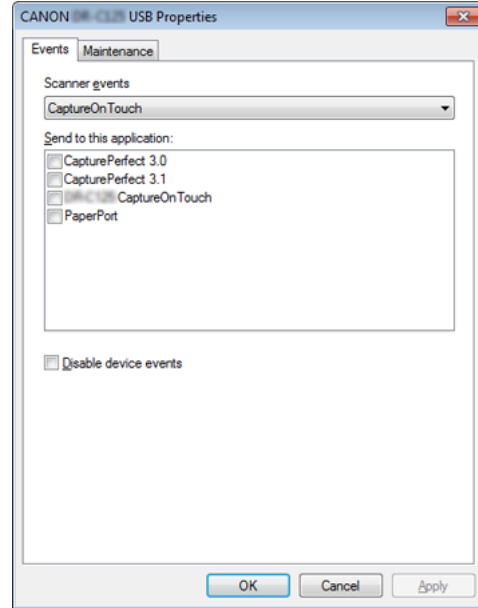

(The [Events] tab may not be displayed, depending on the model.)

**4 Click the [Maintenance] tab and then change the value of [Reduction ratio adjustment].**

The adjustment value can be set within the range from -3.0% to 3.0%.

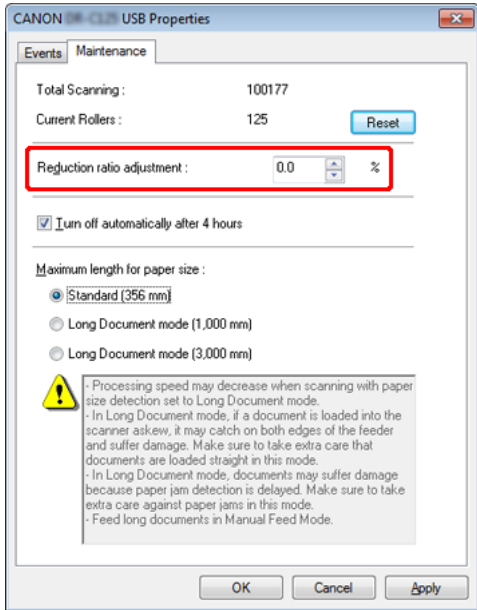

**5 Click [OK] to close the scanner properties.**



**1 Opens the scanner driver's Detail Settings screen.**

See " Select document settings" on p.51.

This will open the advanced settings dialog box for the scanner.

**2 Click  to display the [Scanner Information] dialog box.**

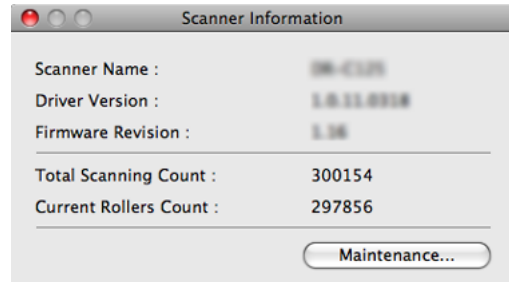

**3 Click [Maintenance] to display the [Maintenance] dialog box.**

**4 Change the value of [Reduction ratio adjustment].**

The adjustment value can be set within the range from -3.0% to 3.0%.

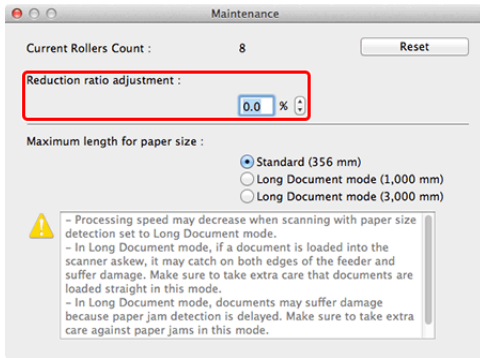

**5 Click  to close the [Maintenance] dialog box.**

# Chapter 10 Replacing Consumable Parts

When replacing the separation pad, perform the following steps to detach it from and attach it to the unit.

- When to replace the consumable parts..... 92**
- Opening and Closing the Front Unit..... 93**
- Replacing the Feed Roller..... 94**
- Replacing the Retard Roller..... 95**
- Resetting the Counters ..... 96**
- Auto Power Off Setting ..... 98**

## When to replace the consumable parts

The two rollers (feed roller and retard roller) installed in the scanner are consumable parts. The feed roller and retard roller wear with scanning. If the feed roller and retard roller are worn, documents may not feed correctly and paper jams or double-feed errors may occur.

When more than 100,000 pages have been fed (total number of pages fed by the scanner), a message prompting you to replace the rollers is displayed when the computer is started.

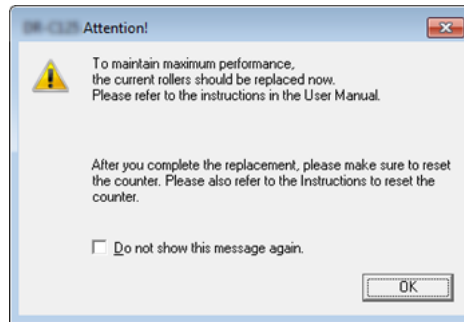

If this message begins to be displayed at startup, purchase an exchange roller kit and replace the worn parts with the consumable parts included in the kit (feed roller and retard roller). For details on the exchange roller kit, see "Exchange roller kit (product code: 5484B001)" on p.111.

Furthermore, the counter in the scanner that records the number of pages fed also needs to be reset when you replace the rollers. (" Resetting the Counters" on p.96 )

## Opening and Closing the Front Unit

- 1 Open the document feed tray. Press the OPEN button and pull open the front unit toward you.

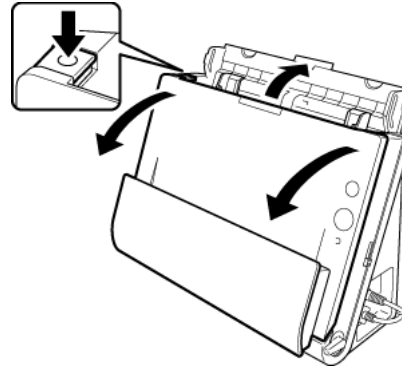

### NOTE

The location of each of the consumable parts is shown below.

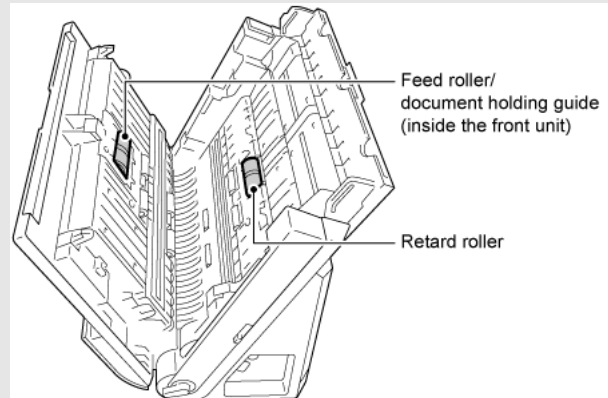

- 2 When closing the front unit, make sure that it is completely closed by gently pressing the left and right until you hear a click.

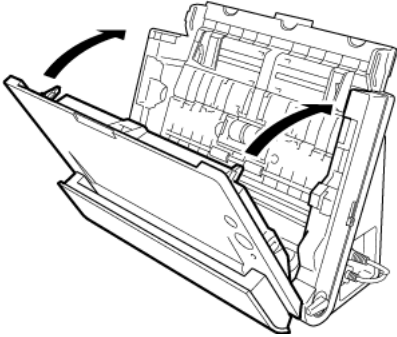

- 3 Close the document feed tray.

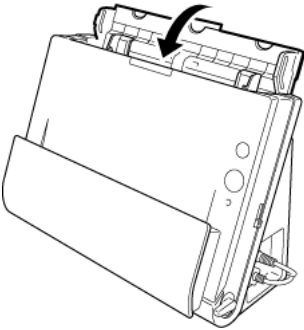

## Replacing the Feed Roller

---

- 1 Open the roller cover.

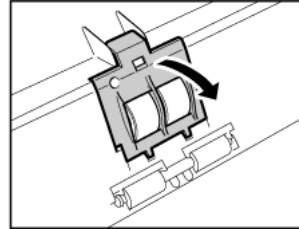

- 2 Slide the feed roller to the left, and then remove it.

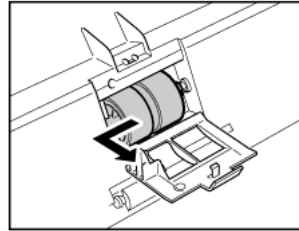

- 3 Install the new feed roller. When installing the feed roller, align the notch on the roller with the shaft of the front unit.

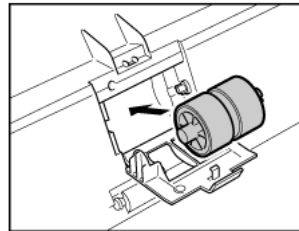

- 4** Slide the roller to the right to secure it.

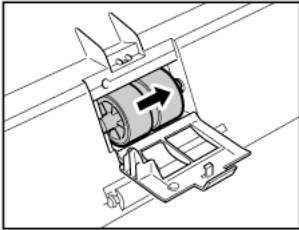

- 5** Close the roller cover. Make sure that it is completely closed by pressing until you hear a click.

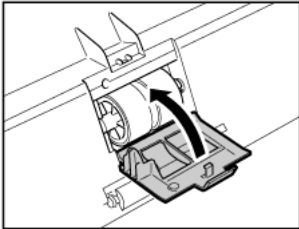

## Replacing the Retard Roller

---

- 1** Open the roller cover.

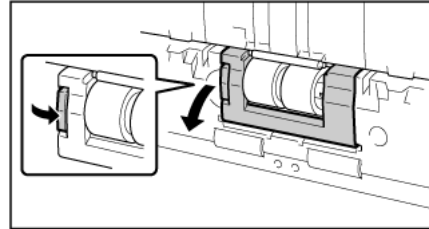

- 2** Remove the retard roller and then install the new retard roller. When installing the retard roller, align the notch on the roller with the shaft of the main unit.

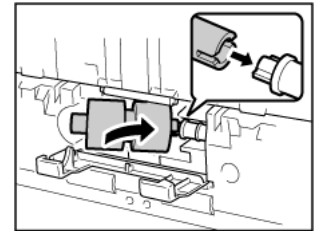
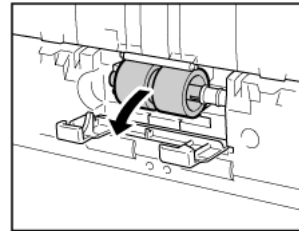

- 3** Close the roller cover. Make sure that it is completely closed by pressing until you hear a click.

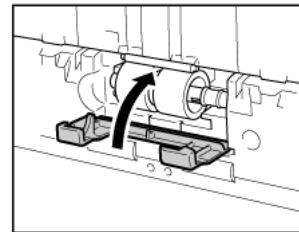



## Resetting the Counters

### Windows

- 1 Start Windows and log in as a user with administrator privileges.
- 2 Click the Start button, and then click [All Programs], [Canon DR-C225], and [Canon imageFORMULA Utility].  
imageFORMULA Utility starts.

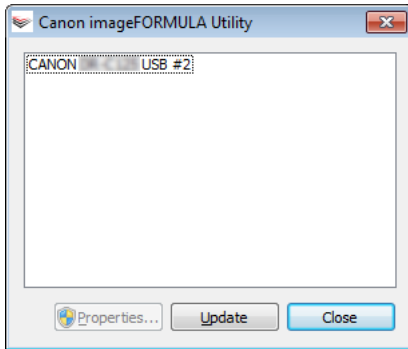

- 3 Click [CANON DR-C225 USB] and click [Properties].

The scanner's properties appear.

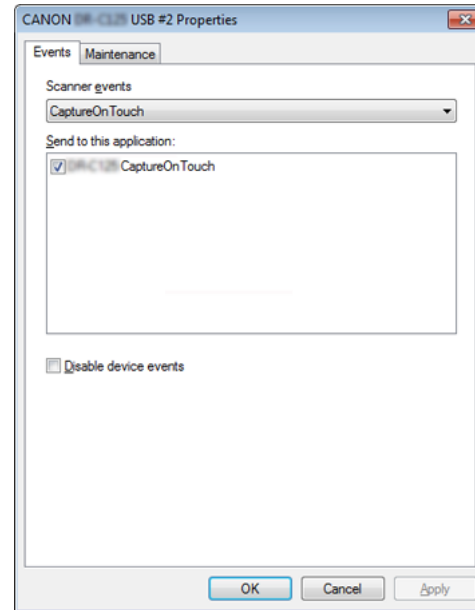

(The [Events] tab may not be displayed, depending on the model.)

4 Click the [Maintenance] tab, and click [Reset].

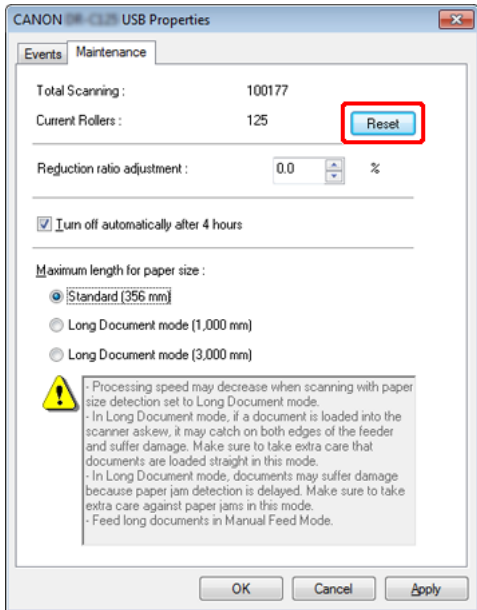

The counter for [Current Rollers] resets.

5 Click [OK] to close the scanner properties.



1 Opens the scanner driver's Detail Settings screen.

See "Select document settings" on p.51.

This will open the advanced settings dialog box for the scanner.

2 Click  to display the [Scanner Information] dialog box.

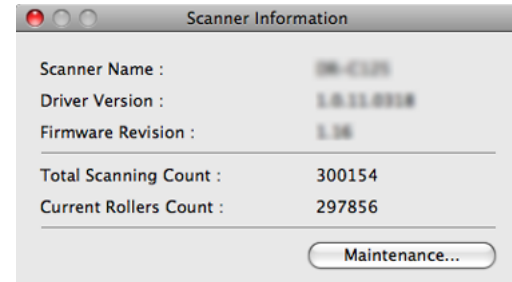

3 Click [Maintenance] to display the [Maintenance] dialog box.

4 Click [Reset].

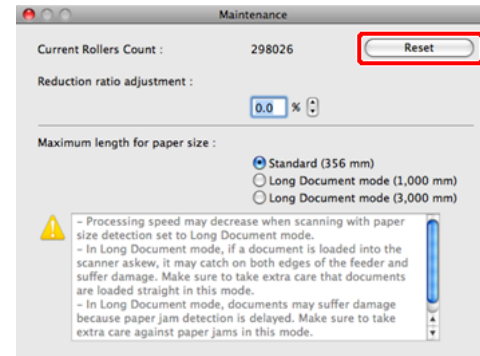

5 Click  to close the [Maintenance] dialog box.

## Auto Power Off Setting

### Windows

The scanner automatically turns off if 4 hours elapse without scanning or another operation being performed.

To disable this setting, follow the procedure below.



### NOTE

The Auto Power Off setting is only available in Windows.

- 1 Start Windows and log in as a user with administrator privileges.
- 2 Click the Start button, and then click [All Programs], [Canon DR-C225], and [Canon imageFORMULA Utility].  
imageFORMULA Utility starts.

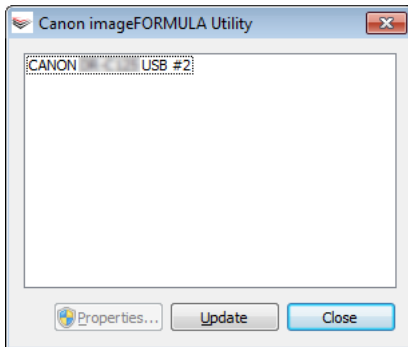

- 3 Click [CANON DR-C225 USB] and click [Properties].  
Scanner properties are displayed.

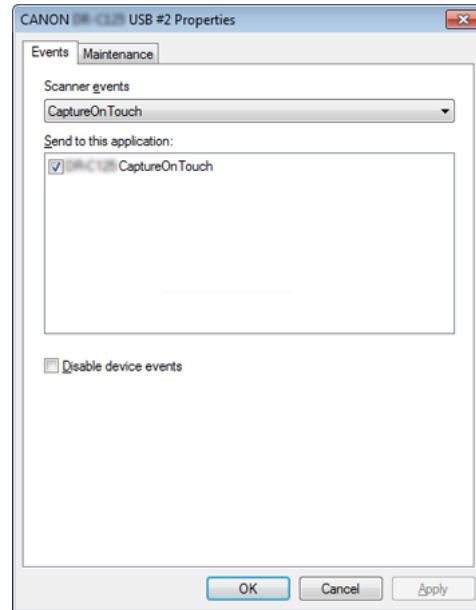

(The [Events] tab may not be displayed, depending on the model.)

- 4 Click the [Maintenance] tab and then clear the [Turn off automatically after 4 hours] check box.

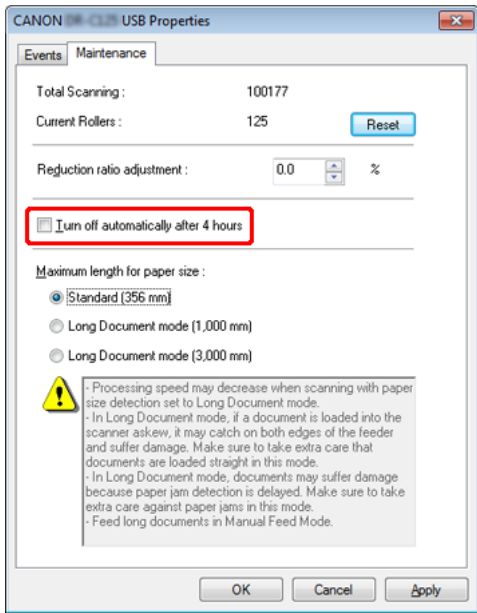

- 5 Click [OK] to close the scanner properties.

## Chapter 11 Uninstalling the Software

If the scan driver or CaptureOnTouch is not operating normally, follow the procedure below to uninstall them. Then, re-install the software from the Setup disc. -> "Software Installation" on p.16

**Uninstallation**..... 100

### Uninstallation

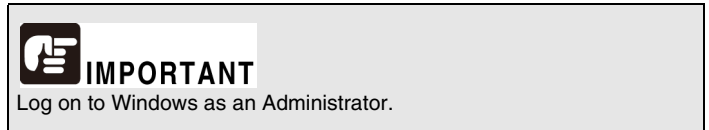

- 1 From the Windows task bar, click the [Start] button, and then [Control Panel].**
- 2 Click [Uninstall a program].**  
The [Uninstall or change a program] dialog box appears.
- 3 From the Programs list, select the software you want to remove and then click [Uninstall].**  
The delete confirmation screen appears.
- 4 Click [Yes].**  
Uninstallation of the software is now complete.



No uninstaller is provided for OS X/macOS drivers. To uninstall, use Finder to delete the following files.

/Library/Image Capture/TWAIN Data Sources/DR-C225.ds

/Applications/CaptureOnTouch

## Chapter 12 Troubleshooting

Clearing a Paper Jam .....	101
Common Problems and Solutions .....	104
Software Troubleshooting .....	106
Useful tips .....	107

### Clearing a Paper Jam

---

---

When paper jams occur during scanning, use the following procedure to clear them.



Be careful when removing jammed paper. It is possible to cut your hand on the edge of a sheet of paper.

- 1 Remove any documents remaining in the feed tray.

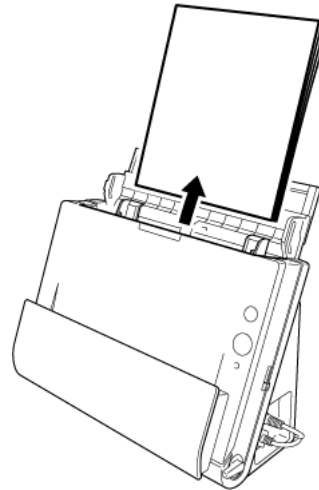

- 2 When the jammed document is on the document ejecting side, open the document eject tray.

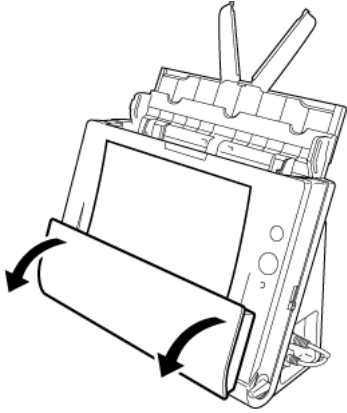

- 3 Remove the jammed document.

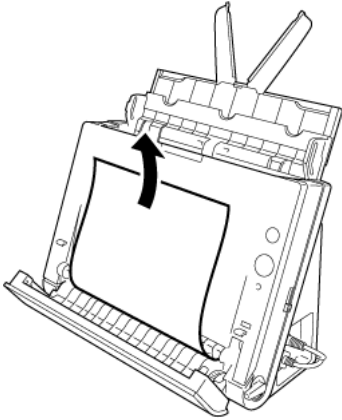

- 4 Return the document eject tray to its original position. Make sure that it is completely closed by pushing until you hear a click.

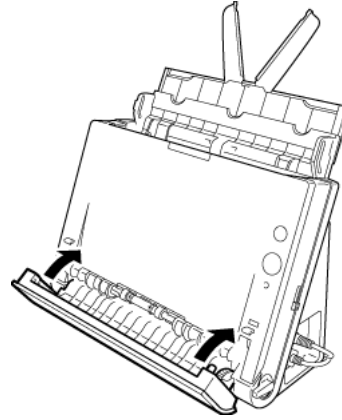

- 5 Press the OPEN button and pull open the front unit toward you.

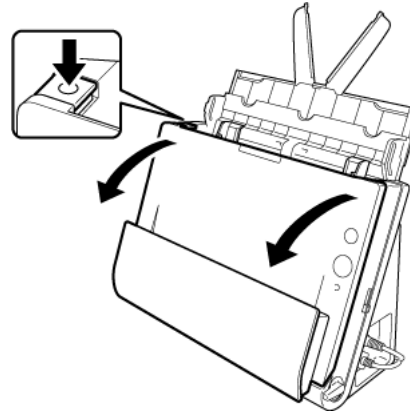

**6 Remove the jammed document.**

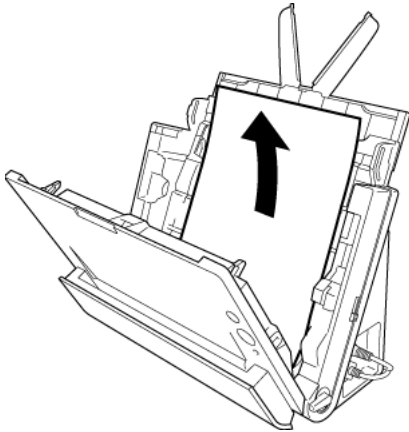

**7 Close the front unit by gently pushing it up on both sides until it clicks into place. Make sure that the front unit is completely closed by pushing until you hear a click.**

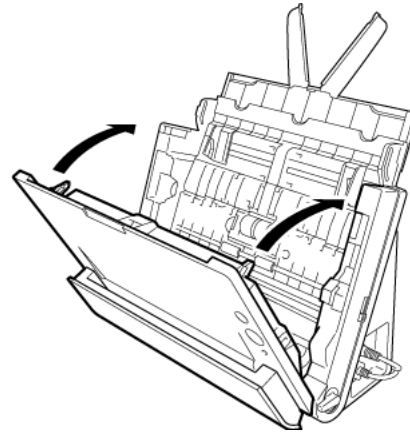

After removing the jammed paper, check to see if the last page was scanned correctly, and then continue scanning.



**IMPORTANT**

Make sure to pull the document out carefully, without applying too much force. If the jammed paper tears while you are pulling it out, make sure to remove any remaining pieces from inside the scanner.



**NOTE**

When a paper jam or other problem occurs while [Rapid recovery system] is enabled in the scanner driver, the image of the last document that was scanned properly is saved before scanning is stopped. Therefore, you can quickly resume scanning after resolving the cause of the interruption. As the image of the document that was being fed at the time of the interruption may not be saved in such cases, be sure to verify the last scanned image before resuming the operation.



## Common Problems and Solutions

---

---

This section provides recommended solutions to common problems.

If you have a problem that is not solved by the following, contact your local authorized Canon dealer.

---

### Q1 The scanner will not turn on.

A1 Confirm that the AC adapter is plugged firmly into a power outlet.

---

### Q2 The scanner is not recognized.

- A2
- 1 Confirm that the scanner is properly connected to the computer with a USB cable.
  - 2 Confirm that the scanner is turned on. See the previous "Problem 1" if the scanner does not turn on.
  - 3 The computer's USB interface may not support the scanner. The scanner cannot be guaranteed to work with all USB interfaces.
  - 4 Confirm that the supplied USB cable is used to connect the scanner to the computer. The scanner cannot be guaranteed to work with all available USB cables.
  - 5 If the scanner is connected to the computer via a USB hub, try removing the hub and connecting directly to the computer.
  - 6 On the DR-C225W II, make sure that the Wireless switch on the back of the scanner is turned off.

---

### Q3 Documents feed askew (scanned images are slanted).

- A3
- 1 Align the document guides to fit the documents as closely as possible, and load the documents so that they feed straightly.
  - 2 Enable [Automatically straightens skewed] (or [Deskew]) in the scanner driver settings.
  - 3 If many pages have been scanned since roller cleaning, clean the rollers. If documents still feed askew, roller replacement or other maintenance may be needed. See "Chapter 9 Regular Maintenance" on p.85 for roller replacement procedures.
- 

---

### Q4 If white lines or streaks appear in scanned images.

A4 Clean both sides of the scanner glass, and the rollers. If a sticky substance such as glue or correction fluid is found, carefully wipe with just enough pressure to clean the area where the lines appear. If the problem cannot be solved by cleaning, the internal glass may be scratched. Contact your local authorized Canon dealer.

---

### Q5 Pages are missing.

A5 Then the scanner driver's [Scanning Side] setting is [Skip blank page], documents with very little black may be unintentionally skipped. Decrease the [Set the likelihood of skipping blank page] value (see "When you want to delete the images of the blank pages in two-sided documents" on p.69 ) or select another scan mode setting such as [Simplex] or [Duplex]. If pages are skipped due to the document double feeding, see "Problem 7 Documents jam (or double-feed)".

---

### Q6 Documents jam (or double-feed).

- A6
- 1 If the roller has been installed correctly, clean it if necessary.
  - 2 Proper scanning may not be possible when document pages stick together due to static electricity. Fan the documents before you load them.
  - 3 Set the feed selection lever to the non separation position, and manually feed the scanner one page at a time.
-

---

**Q7 Multiple pages of scanned images cannot be saved to a single file.**

- A7 Depending on the file format, multiple scanned image pages cannot be saved as a single file with CaptureOnTouch Lite and CaptureOnTouch.
- BMP, PNG, JPEG: Always save one page per file.
  - PPTX: Always saved multiple pages per file.
  - TIFF, PDF: You can save multiple pages to a single file by clicking and selecting in the displayed dialog box.
- For the setting method, see "About file formats" on p.54.

---

**Q8 All of the placed documents have been scanned, but the scanned image does not appear on the application.**

- A8 When [Panel-Feeding] or [Automatic Feeding] is selected as the feeding method on the scanner driver's setting screen, a scanning operation will not continue after all of the documents are fed, as the scanner awaits additional documents to be fed. You can finish the operation and send the scanned images to the application by clicking the [STOP] button on the Scan Panel.

---

**Q9 Memory becomes insufficient and scanning stops.**

- A9 If you configure scanning conditions that use a large amount of the computer's memory, scanning may stop because of insufficient memory. Although this depends on the computer's memory size, the possibility of insufficient memory increases if any of the following scanning conditions overlap.
- [Color Mode] is set to [24-bit Color]
  - A large page size (e.g. Legal) is specified as the [Page Size]. Alternatively, the page size is set to [Scanner's Maximum].
  - A high resolution (600dpi etc.) is specified for [Dots per inch].
- If an error message appears due to insufficient memory while scanning is in progress, exit the application, change the scanning conditions (e.g. reduce the resolution or page size) and then try scanning again. In addition, the amount of memory used can be contained by turning off [Moire Reduction] and [Please change prevent bleed through and remove] if they are set to on.

---

**Q10 Scanned images are upside down.**

- A10 Confirm the scanner driver settings.
- In Windows, confirm that the [Upside-down feeding] check box in the [Feeding] tab is cleared.
- In OS X/macOS, confirm that the [Upside-down feeding] check box in the [More] dialog box is cleared.
-

## Software Troubleshooting

---

---

**This section describes troubleshooting problems and solutions for operating the supplied software (CaptureOnTouch).**

### **If scanning is too slow**

- 1 Close other running programs, if any.**
- 2 Scanning can be slowed down by memory shortage caused by memory-resident applications such as anti-virus programs. Close such memory-resident programs if necessary to free up memory space.**
- 3 When insufficient hard disk space is available, the scanner may be unable to create the necessary temporary files for scanned data. Delete unneeded data on the hard disk to free up more space.**
- 4 Scanning is slow if the computer's USB port is not Hi-Speed USB 2.0 compliant.**
- 5 If using a common USB cable that is not Hi-Speed USB 2.0 compliant, replace the cable with the supplied compliant cable.**
- 6 When the scanner is connected to the computer via a USB hub that is not Hi-Speed USB 2.0 compliant, remove the hub and connect the scanner directly to the computer.**

### **If scanned image files cannot be opened in an application**

- 1 Scanned images saved as multi-page TIFF files can be opened only by programs that support this file format.**
- 2 Images saved as compressed TIFF files (single- as well as multi-page) can only be opened by programs that support the compressed format. This can occur with programs that are not compatible with CaptureOnTouch. In this case, select "None" as the image file compression format before scanning.**

**There is a display glitch on the UI screen of CaptureOnTouch**  
Depending on the computer that you are using, a display glitch may occur on the UI screen when there are too many Scan mode panels, Select output panels, or Scanning Shortcut panels. Delete any panel that you will not use.

## Useful tips

Here are some useful tips for scanning documents.

### Where are scanned images saved? Can the save destination be changed?

Images are saved to the following locations, according to program settings. All destination locations can be changed to other folders.

- CaptureOnTouch  
Both Standard Scanning and Scanning Shotcut save the output to the destination set in the [Select output] panel.

### How are the scan settings configured?

- CaptureOnTouch  
By clicking the Edit button ([]) in the [Select document] panel, you can edit the scan settings when the [Select document edit screen] opens.

### How do I save multiple pages in one file, or save one file per page?

When scanned images are saved in BMP, PNG or JPEG format, each image is always saved in a separate file.

When scanned images are saved in PDF or TIFF format, you can specify multi- or single-page files. See also Q7 in "Common Problems and Solutions" on p.104

### Can I copy or back up scanner setting configurations?

- CaptureOnTouch  
The setting configurations can be backed up and restored using [Back Up/Restore] on the [Maintenance] tab on the [Environmental settings] dialog box.

### What rules apply to scanned image file names?

- CaptureOnTouch 

For both Standard Scanning and Scanning Shotcut, the file names of scanned images are set based on the settings in the [Select output] panel. This screen opens when you click the Edit button ([]) in the [Select output] panel.

Click the [Detail Settings] button on this screen. You can set the file names of scanned images by setting all or some of the three items shown below.

Setting	Description
Start file name with character string	Any specified text string to be included in the file name.
Add date and time	Appends the date and time to file names. Select the date format from the list box. YYYY = year, MM = month, and DD = day of month. The time is appended after the date.
Add counter to file names	Append serial numbers in the order of scanned image saving. Specify the number of digits and starting number.

A sample file name is displayed as the [File name] in the [File name settings] dialog box.

### How do I scan half-folded documents (folio scanning)?

Set the feed method to non separation feeding, and set the folded document in the scanner with the fold at the right (If [Upside-down feeding] is enabled in the scanner driver settings, set the document with the fold at the left.). Specify half-size document (the size after folding) and select [Folio] for the [Scanning Side] in the scanner settings, then scan. For details, "Placing Folded Documents" on p.30.

### How can I skip blank pages, and scan only non-blank pages?

Specify [Skip Blank Page] on the scanner driver setting screen, then scan.

### How do I scan cards?

Set the eject method to straight path, and set the card in the landscape orientation into the scanner. Specify the same size as the card (or [Match original size] (Windows) or [Detect automatically](OS X/macOS)), then scan. For details, see "Placing Cards" on p.29

### How do I load and scan documents with mixed sizes?

Set [Page Size] to [Match original size] (Windows) (or [Detect automatically](OS X/macOS)) on the scanner driver settings screen, then scan. For details, see "To scan unregistered size documents" on p.67

### What's the best way to scan business cards or photos?

Set [Page Size] to [Match original size] (Windows) (or [Detect automatically](OS X/macOS)) on the scanner driver settings screen, then scan. Alternatively, register the size of the cards or photos to be scanned. For details, see "To scan unregistered size documents" on p.67

### How do I print scanned data?

- CaptureOnTouch
  - For both Standard Scanning and Scanning Shotcut, select [Print] in the [Destination] panel.
  - To use this function, you need to install a plug-in.
  - The plug-in can be installed by selecting its checkbox when installing CaptureOnTouch.

### How do I save scanned data in a shared folder?

- CaptureOnTouch
  - In CaptureOnTouch, destinations other than [Save to folder] are provided as a plug-in.
  - By installing the plug-in, the scanned image can be printed, attached in an e-mail, or shared using various cloud services.
  - The plug-in can be installed by selecting its checkbox when installing CaptureOnTouch.
  - The available output destinations vary depending on the installed plug-in.

### How can I attach scanned data to an e-mail (or send it as e-mail)?

- CaptureOnTouch
  - For both Standard Scanning and Scanning Shotcut, select [Attach to E-mail] in the [Destination] panel.
  - To use this function, you need to install a plug-in.
  - The plug-in can be installed by selecting its checkbox when installing CaptureOnTouch.

### How do I use the automatic document color detection function?

The scanner driver for this scanner includes a function that automatically detects the color mode from the contents of a document.

The color modes that can be detected automatically by this function depend on the application and scanner driver settings you are using as follows.

Condition	Modes that can be detected
When [Color mode] is set to [Detect automatically] in the CaptureOnTouch scanner settings	[Color or Gray]
When [Full Automatic Mode] is selected in the scanner driver	
When [Color mode] is set to [Detect automatically] in CapturePerfect or in the scanner driver, and advanced settings for auto-detection are set	One of the following can be selected: <ul style="list-style-type: none"><li>• [Color or Gray]</li><li>• [Color or Binary]</li><li>• [Color, Gray or Binary]</li></ul>

## Chapter 13 Appendix

Specifications .....	109
Replacement parts.....	111
Option .....	111
About the Flatbed Scanner Unit 102/201 .....	111
External Dimensions .....	112

## Specifications

---

### Main Unit

Type	Desktop sheetfed scanner	
Scanning Document Size		
Plain Paper	Width	50.8 mm to 216 mm (2" to 8.5" )
	Length	53.9 mm to 356 mm (2.12" to 14" ) (You can scan documents up to 3,000 mm (118.1" ) long by setting the scanner to the Long Document mode.)
	Thickness	When U-turn path: 52 to 128 g/m <sup>2</sup> (14 to 34 lb bond) 0.06 to 0.15 mm (0.0024" to 0.0059" ) When straight path: 40 to 209 g/m <sup>2</sup> (11 to 58 lb bond) 0.05 to 0.25 mm (0.002" to 0.0098" )
Business Card	Size:	50.8 mm x 53.9 mm (2" x 2.12" ) or larger
	Paper weight:	300 g/m <sup>2</sup> (80 lb bond) 0.35 mm (0.0138" ) or less
	Orientation:	Vertical feeding only
Card	Size:	53.9 mm x 85.5 mm (2.12" x 3.37" ) (ISO standard)
	Thickness:	0.76 mm (0.03" ) or less, 1.4 mm (0.055" ) or less for the embossment
	Orientation:	Horizontal feeding only
	Feed path:	Straight path only Embossed cards can be scanned.
Document Feeding Method	Automatic	
Scanning Sensor	Contact image sensor	
Light source	LED	
Scanning Side	Simplex/duplex	
Scanning modes	Black and White, Error Diffusion, 256-level Grayscale, Advanced Text Enhancement, Advanced Text Enhancement II, 24-bit Color	
Scanning resolution	150 x 150dpi/200 x 200dpi/300 x 300dpi/ 400 x 400dpi/600 x 600dpi	

Scanning Speed (Conditions: Core i7 2.8GHz CPU, 4 GB memory, A4 document size, during connection to a computer running Windows)

When connecting with USB cable

Black and white	Simplex	200dpi 25 pages/min. 300dpi 25 pages/min.
	Duplex	200dpi 50 images/min. 300dpi 50 images/min.
Grayscale	Simplex	200dpi 25 pages/min. 300dpi 25 pages/min.
	Duplex	200dpi 50 images/min. 300dpi 50 images/min.
24-bit Color	Simplex	200dpi 25 pages/min. 300dpi 15 pages/min.
	Duplex	200dpi 50 images/min. 300dpi 30 images/min.

Wi-Fi connection (Actual scanning speeds may differ from the below depending on the connected device and communication status.)

Black and white	Simplex	200dpi 25 pages/min. 300dpi 25 pages/min.
	Duplex	200dpi 50 images/min. 300dpi 35 images/min.
Grayscale	Simplex	200dpi 25 pages/min. 300dpi 25 pages/min.
	Duplex	200dpi 50 images/min. 300dpi 35 images/min.
24-bit Color	Simplex	200dpi 25 pages/min. 300dpi 15 pages/min.
	Duplex	200dpi 50 images/min. 300dpi 27 images/min.

Interface Hi-Speed USB 2.0

Other functions Folio scanning

External Dimensions

300 mm (11.81")(W) x 220 mm (8.66")(H) x 156 mm (6.14")(D)  
(with the feed tray close).

300 mm (11.81")(W) x 339 mm (13.3")(H) x 235 mm (9.25")(D)  
(with the feed tray open).

Weight (without AC adapter)

DR-C225 II Approximately 2.7 kg (5.95 lb)

DR-C225W II Approximately 2.8 kg (6.17 lb)

Power Supply

(using AC adapter)

DC16V 0.7A

Power Consumption  
DR-C225 II 100V

120V

200 - 240V

DR-C225W II 100V

120V

200 - 240V

Noise

Operating Temperature: 10°C to 32.5°C (50°F to 90.5°F)

Environment Humidity: 20% to 80% RH

Scanning: maximum 12.7 W  
In the sleep mode: maximum 1.7 W

With power switch OFF: maximum 0.5 W

Scanning: maximum 12.7 W  
In the sleep mode: maximum 1.7 W

With power switch OFF: maximum 0.5 W

Scanning: maximum 12.8 W  
In the sleep mode: maximum 1.8 W

With power switch OFF: maximum 0.5 W

Scanning: maximum 15.6 W  
In the sleep mode: maximum 4.4 W

With power switch OFF: maximum 0.5 W

Scanning: maximum 15.6 W  
In the sleep mode: maximum 4.3 W

With power switch OFF: maximum 0.5 W

Scanning: maximum 15.6 W  
In the sleep mode: maximum 4.4 W

With power switch OFF: maximum 0.5 W

Not more than 56 dB

## AC Adapter (100 to 240 V type)

Model Number MG1-5042

Input AC 100 to 240 V, 50/60 Hz, 0.57 to 0.32 A

Output DC 16 V, 1.6 A

Weight Approximately 0.2 kg (0.44 lb) (excluding power cord)

## Replacement parts

---

### Exchange roller kit (product code: 5484B001)

Kit to replace the rollers (feed roller, retard roller) and document holding guide.

For the replacement procedure, see "When to replace the consumable parts" on p.92 .



#### IMPORTANT

Contact your local authorized Canon dealer or service representative for detailed information about the replacement parts.

Product specifications are subject to change without notice.

## Option

---



### Flatbed Scanner Unit 102 (product code: 2152Cxxx)

Flatbed scanner unit that can be connected to and used with a DR scanner\*. Connecting the unit to this scanner enables you to use this scanner as a flatbed scanner with an automatic document feeder.

\* The DR-C225W II is compatible only with a USB connection.

### Flatbed Scanner Unit 201 (product code: 6240Bxxx)

A flatbed scanner unit that can be used by connecting to a DR scanner\* and supports A3 size paper. Connecting the unit to this scanner enables you to use this scanner as a flatbed scanner with an automatic document feeder.

\* The DR-C225W II is not compatible.

## About the Flatbed Scanner Unit 102/201

---

The optional Flatbed Scanner Unit 102/201 can be connected to and used with this scanner.

### System requirements

The computer must comply with the necessary system requirements of Flatbed Scanner Unit 102/201.

The scanner driver of Flatbed Scanner Unit 102/201 needs to be installed to use the unit.

### About Use with CaptureOnTouch

#### About Assigning Function to Start Button

When you connect Flatbed Scanner Unit, you can assign Scanning Shortcut of CaptureOnTouch to the start button of Flatbed Scanner Unit.

#### Limitation of Restarting with Start Button

When CaptureOnTouch is set not to be resident in memory, CaptureOnTouch cannot be restarted by pressing the start button on Flatbed Scanner Unit after you end CaptureOnTouch.

#### About Setting up the Scanner Driver

When functions of this scanner cannot be selected with the Flatbed Scanner Unit settings dialog box, click [Option] in the dialog box to open the scanner driver and make the required settings.



#### NOTE

The unit cannot be used with OS X/macOS.



## External Dimensions

---

### ■ Front View

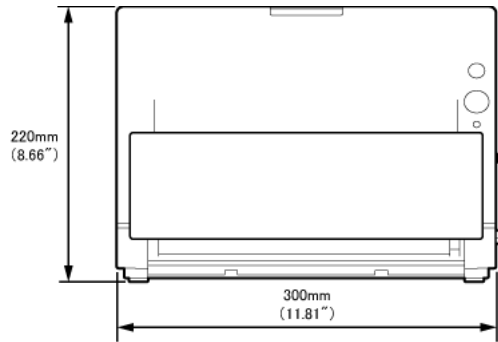

### ■ Side View

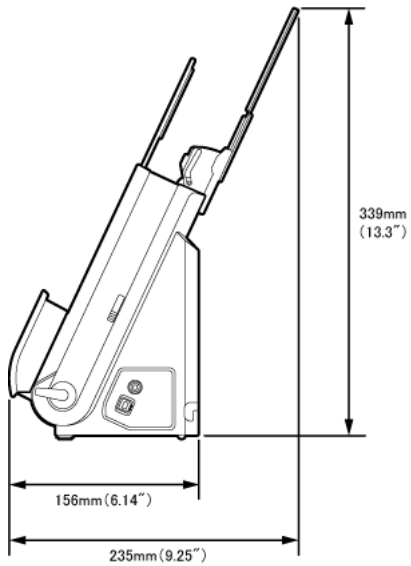

## Safety-related markings on the machine

Marquages de sécurité sur la machine

Marche di sicurezzza sulla macchina

Sicherheitshinweise auf der Maschine

Marcas de la máquina relacionadas con la seguridad

Veiligheidsmarkeringen op de machine

Makine üzerindeki güvenlik işaretleri



[English]	Switch (On)	Power on
[Français]	Commutateur (Marche)	Sous tension
[Italiano]	Interruttore (On)	Alimentazione presente
[Deutsch]	Schalter (Ein)	Eingeschaltet
[Español]	Interruptor (encendido)	Máquina encendida
[Nederlands]	Schakelaar (On)	Aan
[Türkçe]	Anahtar (Açık)	Güç açık



[English]	Switch (Off)	Power off (no standby current)
[Français]	Commutateur (Arrêt)	Hors tension (pas de courant de veille)
[Italiano]	Interruttore (Off)	Alimentazione assente (nessuna corrente di standby)
[Deutsch]	Schalter (Aus)	Ausgeschaltet (ohne Ruhestromaufnahme)
[Español]	Interruptor (apagado)	Máquina apagada (sin corriente en espera)
[Nederlands]	Schakelaar (Off)	Uit (geen stand-byverbruik)
[Türkçe]	Anahtar (Kapalı)	Güç kapalı (bekleme akımı yok)



[English]	Switch (Standby)	Power on/off (standby current on)
[Français]	Commutateur (Veille)	Sous/hors tension (courant de veille activé)
[Italiano]	Interruttore (Standby)	Alimentazione on/off (corrente di standby presente)
[Deutsch]	Schalter (Standby)	Ein- und Ausschalten (mit Ruhestromaufnahme)
[Español]	Interruptor (en espera)	Máquina apagada/encendida (con corriente en espera)
[Nederlands]	Schakelaar (Standby)	Aan-uit (stand-byverbruik aan)
[Türkçe]	Anahtar (Bekleme)	Güç açık/kapalı (bekleme akımı açık)



[English]	Switch (Push-On/Push-Off)	Power on/off (no standby current)
[Français]	Commutateur (Appuyer pour mettre en marche/Appuyer pour arrêter)	Sous/hors tension (pas de courant de veille)
[Italiano]	Interruttore a pulsante bistabile (On/Off)	Alimentazione on/off (nessuna corrente di standby)
[Deutsch]	Schalter (Ein- und Ausschalten durch Drücken)	Ein- und Ausschalten (ohne Ruhestromaufnahme)
[Español]	Interruptor (pulsado para encendido/apagado)	Encendido/apagado (sin corriente en espera)
[Nederlands]	Schakelaar (Push-On/Push-Off)	Aan-uit (geen stand-byverbruik)
[Türkçe]	Anahtar (Bas-Aç/Bas-Kapa)	Güç açık/kapalı (bekleme akımı yok)



[English]	Heat hazard	Heat hazard
[Français]	Danger de chaleur	Danger de chaleur
[Italiano]	Pericolo: temperature elevate	Pericolo: temperature elevate
[Deutsch]	Überhitzungsgefahr	Überhitzungsgefahr
[Español]	Peligro de calentamiento	Peligro de calentamiento
[Nederlands]	Verbrandingsgevaar	Verbrandingsgevaar
[Türkçe]	Isı tehlikesi	Isı tehlikesi



[English]	Class II equipment	Indicates this is Class II equipment
[Français]	Équipement de classe II	Indique qu'il s'agit d'un équipement de classe II
[Italiano]	Apparecchio classe II	Indica che questo è un apparecchio di classe II
[Deutsch]	Gerät der Schutzklasse II	Gibt an, dass das Gerät der Schutzklasse II entspricht
[Español]	Equipo de clase II	Indica que se trata de un equipo de clase II
[Nederlands]	Klassell-apparaat	Geeft aan dat deze apparatuur in Klasse II hoort
[Türkçe]	Sınıf II ekipman	Bunun Sınıf II ekipman olduğunu gösterir

	[English]	DC symbol	Indicates direct current
	[Français]	Symbole CC	Indique qu'il s'agit de courant continu
	[Italiano]	Simbolo corrente continua (C.C.)	Indica la corrente continua
	[Deutsch]	Gleichstrom-Symbol	Kennzeichnet Gleichstrom
	[Español]	Símbolo CC	Indica corriente continua
	[Nederlands]	DC-pictogram	Geeft gelijkstroom aan
[Türkçe]	DC sembolü	Düz akımı gösterir	

	[English]	DC polarity	Indicates the power plug polarity
	[Français]	Polarité CC	Indique la polarité de la fiche d'alimentation
	[Italiano]	Polarità C.C.	Indica la polarità dello spinotto di alimentazione
	[Deutsch]	Gleichstrompolarität	Gibt die Polarität des Netzsteckers an
	[Español]	Polaridad de CC	Indica la polaridad del conector de alimentación
	[Nederlands]	DC-polariteit	Geeft de polariteit van de stekker aan
[Türkçe]	DC polaritesi	Fiş polaritesini gösterir	

	[English]	Electrostatic precaution	Avoid applying static electricity to the machine
	[Français]	Précaution électrostatique	Évitez de soumettre cette machine à de l'électricité statique
	[Italiano]	Protezione dalle cariche elettrostatiche	Evitare di applicare cariche elettrostatiche alla macchina
	[Deutsch]	Warnung vor elektrostatischer Aufladung	Elektrostatische Aufladung der Maschine vermeiden
	[Español]	Precaución electroestática	No aplique electricidad electroestática
	[Nederlands]	Elektrostatische voorzorgen	Voorkom statische elektriciteit op de machine
[Türkçe]	Elektrostatik önlemleri	Makineye statik elektrik vermeyin	